

## Celia Air Tight Plus Celia Air Tight Plus C

PELLET STOVE



For all updates visit [www.edilkamin.com](http://www.edilkamin.com)

*The original language of this edition is Italian*

The undersigned company, EDILKAMIN S.p.A., with registered office in Via P. Moscati 8 - 20154 Milan - tax code and VAT number 00192220192

Hereby declares, under its sole responsibility, that:  
The pellet stoves mentioned below comply with EU Regulation 305/2011 and the harmonised EU standard EN 14785:2006

PELLET STOVES, bearing the EDILKAMIN brand, called  
CELIA AIR TIGHT PLUS C  
CELIA AIR TIGHT PLUS

SERIAL NO.: Rating plate  
CELIA AIR TIGHT PLUS C/ CELIA AIR TIGHT PLUS  
Performance declaration (DoP - EK n° 192)

Moreover, the company hereby declares that:  
the CELIA AIR TIGHT PLUS C/ CELIA AIR TIGHT PLUS wood pellet stoves satisfy the requirements of the following European directives:

2014/35/EU - Low Voltage Directive  
2014/30/EU - Electromagnetic Compatibility Directive  
2011/65/EU - RoHS2 Directive on the restriction of the use of certain hazardous substances in electrical and electronic equipment  
2009/125/EC - Ecodesign  
2010/30/EU - Labelling

Dear Sir/Madam

We thank you for and congratulate you on choosing our product. Before using it, we would ask you to read this manual carefully, so that you can make the most of all its functions in total safety.

This manual is an integral part of the product. We ask you to keep it for the entire lifetime of the product. If you lose it, you can request a copy from your dealer or download it from [www.edilkamin.com](http://www.edilkamin.com).

### Readers of the manual

This manual is addressed to:

- those who use the product at home ("USER");
- the technician who will install the product ("INSTALLER").

The target person of each page is indicated in a band at the bottom of the page (USER or INSTALLER).

### General information

After unpacking the product, check the condition and completeness of the contents.

In the event of error, immediately contact the retailer where the purchase was made, providing him with a copy of the warranty booklet and sales receipt.

The appliance must be installed and operated in compliance with local and national law and European regulations. For the installation, and for anything not specifically indicated in the manual, observe local regulations.

The diagrams provided in this manual are for illustration purposes only: they do not always strictly refer to your specific model, and are not binding in any way.

### Product identification and warranty.

The product is uniquely identified by a number, the "counterfoil", which is indicated on the warranty certificate.

Please keep:

- the warranty certificate accompanying the product
- the purchase receipt given to you by the retailer
- the declaration of conformity given to you by the installer.

The warranty conditions are given in the warranty certificate accompanying the product.

The warranty, however, covers only demonstrable manufacturing defects and not, for instance, problems resulting from improper installation or calibration.

#### MEANING OF SYMBOLS

In some parts of the manual the following symbols are used:



#### PLEASE NOTE:

carefully read and understand the message in question, since failure to follow the instructions in it could cause serious damage to the product and put the safety of those using it at risk.



#### INFORMATION:

failure to comply with these requirements will compromise product use.



#### OPERATING SEQUENCE:

follow the instructions for the operations described.

This appliance can be used by children aged from 8 years and above and persons with reduced physical, sensory or mental capabilities or lack of experience and knowledge if they have been given supervision or instruction concerning use of the appliance in a safe way and understand the hazards involved.

- Children shall not be allowed to tamper with the controls or play with the appliance.
- Cleaning and user maintenance shall not be made by children without supervision.

- The product is not designed for use by people, including children, with limited physical, sensory and mental abilities.
- The appliance is not designed for cooking purposes.
- The appliance is designed to burn UNI EN ISO 17225-2 category A1 wood pellets, in the amounts and manner described in this manual.
- The appliance is designed for indoor use and in areas with normal humidity conditions.
- Keep the product in a dry place out of the weather.
- For the legal and company warranties, refer to the warranty certificate inside the product: specifically, neither Edilkamin nor the retailer are liable for damage resulting from incorrect installation or maintenance.

Safety risks may be caused by:

- Installation in non-suitable settings, in particular those that are subject to fire risks. **DO NOT INSTALL THE PRODUCT IN AREAS SUBJECT TO THE RISK OF FIRE.**
- Contact with fire and hot parts (e.g. glass panel and pipes). **DO NOT TOUCH HOT PARTS** and, when the stove is switched off and still hot, always wear the glove.
- Contact with live electrical equipment (internal). **DO NOT ACCESS THE INTERNAL ELECTRICAL EQUIPMENT WHILE THE APPLIANCE IS POWERED ON.** Electrocution hazard.
- Use of improper ignition aids (e.g. alcohol). **DO NOT IGNITE OR BOOST THE FLAME WITH FLUID SPRAYS OR A FLAME TORCH.** Serious risk of burns, damage and injury.
- Use of fuel other than wood pellets. **DO NOT BURN WASTE MATTER, PLASTIC OR MATERIALS OTHER THAN WOOD PELLETS IN THE COMBUSTION CHAMBER.** The product may become soiled, the flue may catch fire, and environmental damage may ensue.
- Cleaning the combustion chamber when hot. **DO NOT CLEAN WITH A VACUUM CLEANER WHEN HOT.** You could damage the vacuum-cleaner and risk the emission of smoke in the room.
- Cleaning the smoke duct with cleaning products. **DO NOT CLEAN THE PRODUCT WITH FLAMMABLE PRODUCTS.** Risk of fire or blowback.
- Cleaning the glass pane while hot or with unsuitable cleaning products. **DO**

**NOT CLEAN HOT GLASS WITH WATER. ONLY USE RECOMMENDED GLASS CLEANING PRODUCTS.** Risk of cracking and permanent, irreparable damage to the glass.

- The storage of flammable materials at a distance which is less than the safe distances listed in this manual. **DO NOT PLACE LAUNDRY ON THE APPLIANCE. DO NOT PLACE DRYING RACKS WITHIN THE SAFETY CLEARANCE.** Keep flammable fluids away from the appliance. Fire hazard.
- Blocking the aeration vents and air intakes in the room. **DO NOT BLOCK THE AERATION VENTS OR FLUE.** Risk of smoke returning into the room with consequent damage and injury.
- Use of the product as a support or ladder. **DO NOT CLIMB ONTO THE PRODUCT OR USE IT AS A SUPPORT.** Risk of damage and injury.
- Use of the stove with the combustion chamber open. **DO NOT USE THE PRODUCT WITH ITS DOOR OPEN.**
- Incandescent material may come out from the open door. **DO NOT** throw incandescent material outside the appliance. Fire hazard.
- Use of water in case of fire. **CALL THE AUTHORITIES** if a fire breaks out.

Switch on the product only after complete installation including coverings. Risk of electric shock from live device parts.

If you have doubts, please do not take any action, but contact the retailer or the installer.

For reasons of safety, read the user instructions included in this manual.

**DIMENSIONS (cm)**

**Celia Air Tight Plus**

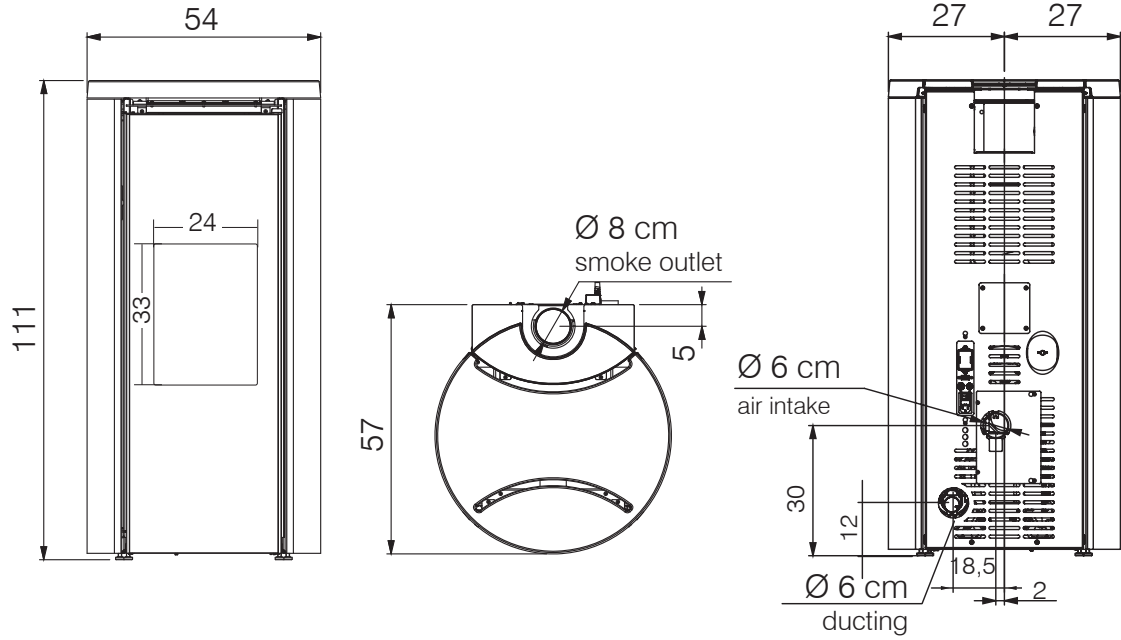

**Celia Air Tight Plus C**

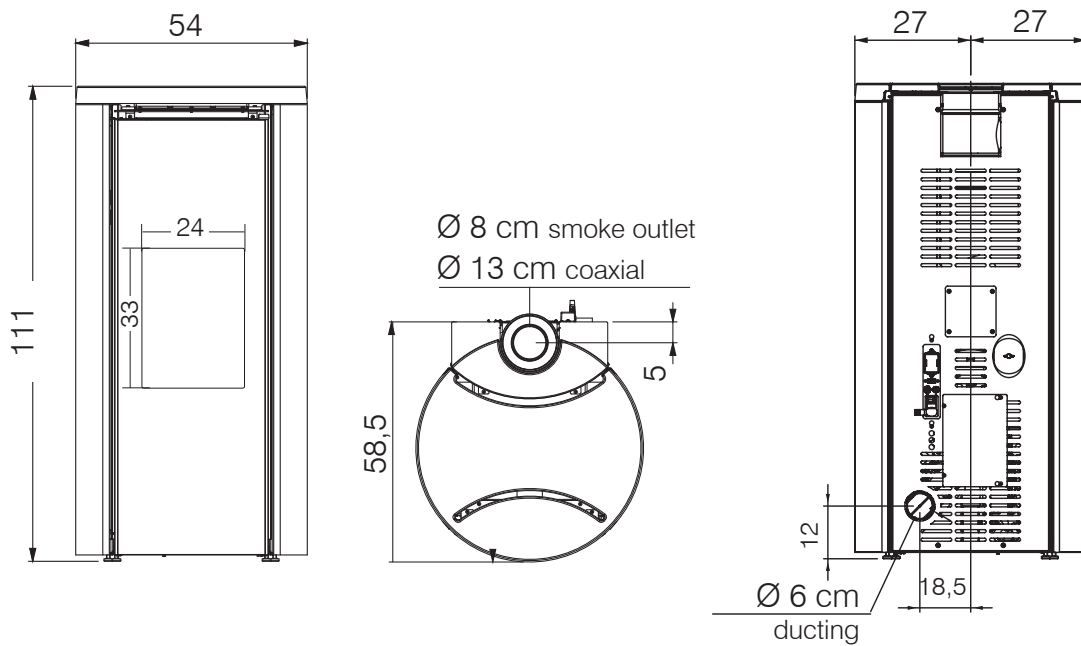

**TECHNICAL CHARACTERISTICS in accordance with EN 14785**

	<b>Celia Air Tight Plus Celia Air Tight Plus C</b>		
	Nominal power	Reduced power	
Available power	9,6	2,7	kW
Efficiency	90,7	89,9	%
CO emissions at 13% O <sub>2</sub>	0,001	0,017	%
Fumes temperature	182	119	°C
Fuel consumption**	2,2	0,6	kg/h
Tank capacity	16		kg
Draw	11	10	Pa
Autonomy	7	27	ore
Heatable volume **	250		m <sup>3</sup>
Fume duct diameter	8/13		mm
Weight including packaging	145		kg
Energy efficiency class according to UE 2015-1186 regulation (Class A+ +/G)	A+ +		

\*A calorific value of 4.8 kW/Kg has been used to calculate consumption.

\*\* The heatable volume is calculated based on the assumption of a heating demand of 33 Kcal/m<sup>3</sup> hour.

**TECHNICAL DATA FOR SIZING THE FLUE**

which must in any case satisfy the requirements of this sheet and the installation instructions

	Nominal power	Reduced power	
Fumes temperature at smoke outlet	227	143	°C
Minimum draw	0,01		Pa
Fumes	5,5	3	g/s
Typ DIBt	CC 50		

**ELECTRICAL SPECIFICATIONS**

Power supply	230 Vac +/- 10% 50 Hz
Mean absorbed power	180 W
Reduced absorption Power	50 W
Stand by absorption Power	2 W
Absorbed power on ignition	365 W
Remote control frequency (provided)	2,4 GHz
Protection rating	Fuse 4 AT, 250 Vac 5x20

**EDILKAMIN s.p.a. Reserves the right to modify the product without notification in the interests of improvement.**

**UNPACKING AND PREPARATION**

Packing employed materials are not toxic or harmful and do not require specific disposal.

Storage, disposal or possible recycling must be provided by the user in compliance with relative applicable laws.



Each handling operation must be performed in vertical position by appropriate means and in accordance with current safety regulations.  
Do not overturn the packaging.

**DEFLECTOR**

The product is supplied with the deflector not installed: insert it as shown in the figure.

The deflector is a component subject to wear. Neither Edilkamin nor the dealer shall be held liable should this component break, all the more if it breaks accidentally during handling operations.

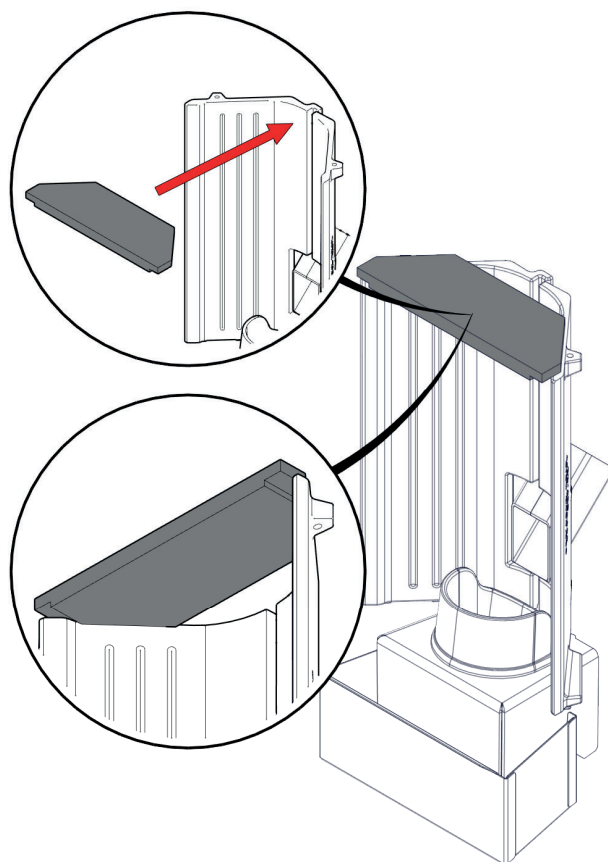

**INDICATIVE DRAWINGS, NOT ALWAYS REFERRING TO THE SPECIFIC MODEL.**

Stoves are delivered with the coatings fitted.

Unscrew and remove them from the top to take the stove off from the pallet.



DO NOT REMOVE THE PRODUCT FROM THE PALLET BEFORE OPENING THE DOOR AND LOOSENING THE SCREWS.

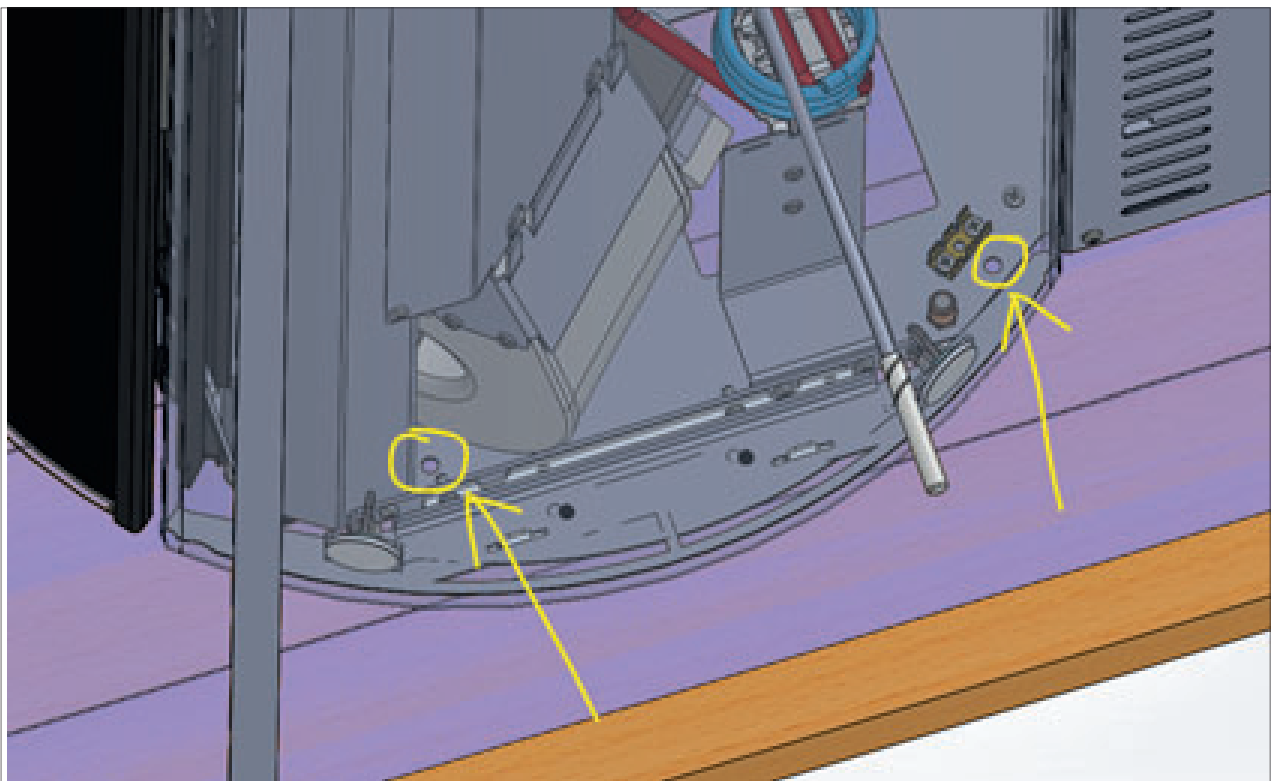

**THE DRAWINGS ARE FOR GUIDANCE ONLY, USEFUL FOR THE INSTALLATION, BUT THEY MAY NOT REFER TO THE SPECIFIC MODEL.**



**REMARKS ON INSTALLATION**

Note that:

- installation must be carried out by authorised technical personnel;
- the appliance must be installed and operated in compliance with local and national law and European regulations. The Italian reference standard is UNI 10683; in France one must follow the instructions in the DTA (Document Technique d'Application Référence Avis Technique), [www.cstb.fr](http://www.cstb.fr)
- if installed in a condominium, the appliance must be approved by the administrator;
- if installed in public premises, check and follow local regulations for this type of installation.

Here are a few general instructions, although these do not obviate the need to comply with local regulations and do not affect the installer's liability for the installation.

Remember that Rada Air Tight C is sealed, in other words, if it is installed correctly with the air inlet pipe connected to the outside, it takes the majority of the air from the outside. For different countries, check if there are particular installation conditions allowed for sealed stoves.

**Checking the suitability of the installation space**

- The room must have a volume of at least 30 m<sup>3</sup>
- The floor must be able to bear the weight of the product and its accessories\* (see the note in the paragraph on the heat protection)
- Level the appliance
- Pursuant to Standard 10683 rev. 2012 point 6.3, in Italy you can also install the appliance in bedrooms or in rooms which already include a product that takes air from it for combustion, provided that the air inlet is connected to the outside
- Do not install the product in spaces where there is a risk of fire or explosion
- In Italy, check the compatibility pursuant to UNI 10683 and UNI 7129 in the presence of gas fired products.

**Protection from heat and safety clearances**

The surfaces of the building adjacent to the product must be protected against overheating.

The insulation to be used will depend on the type of surface in question.

The appliance must be installed in accordance with the following safety instructions:

- minimum clearance at the sides 10 cm and back of 5 cm from flammable materials
- no flammable materials may be kept closer to the front of the appliance than 80 cm.

If connected to a wooden or otherwise flammable wall, the flue must be appropriately insulated.

If installed on a flammable or combustible floor, or which is not capable of bearing its load\*, use steel or glass plates under the stove to distribute the load.

Contact the retailer for this type of optional.

**Positioning the product**

The product is designed to operate in all climate conditions. In special circumstances, such as strong wind, the safety devices may intervene to switch the appliance off.

Contact the authorised Edilkamin Technical Assistance Centre.

**INSTRUCTIONS FOR THE SMOKE DISCHARGE WITH OR WITHOUT CONCENTRIC PIPE**

**FLUE SYSTEM**

**(fumes duct, flue and chimney pot)**

This chapter has been drawn up pursuant to European regulations EN 13384, EN 1443, EN 1856 and EN 1457. The installer must observe both these and any other local regulations. This manual does not in any way substitute such regulations.

The product must be connected to a flue system which ensures that the fumes produced by combustion are expelled in complete safety.

Before positioning the appliance, the installer must check that the flue is suitable.

**FUMES DUCT, FLUE**

The fumes duct (which connects the combustion chamber smoke outlet with the flue) and the flue itself must, among other regulatory requirements:

- receive the fumes from a single product (the outlets of multiple appliances may not be conveyed into a single flue)
- be routed vertically for the most part
- have no downwards sloping sections
- preferably have a circular internal cross section, or with a ratio of the sides of less than 1.5
- terminate at roof level with a proper chimney pot: the flue may not discharge directly on the wall or into an enclosed space, even if the space in question is open to the sky
- be made of material with rated fire reaction class A1 as per UNI EN 13501 or analogous national regulations
- be certified, with a chimney plate if metal
- be of uniform cross section or vary in cross section only immediately after the outlet, not at some midpoint of its length.

**THE FUMES DUCT**

- Further to the general prescriptions for the fumes duct and flue, the fumes duct:
- may not be made of flexible metal material
- must be insulated, if routed through unheated areas or outdoors
- must not be routed through rooms where the installation of combustion heat generators is prohibited or there is risk of fire, or that cannot be inspected
- must enable the recovery of soot and be open for inspection
- must have a maximum of 3 bends with a maximum angle of 90°
- if there is a horizontal section, it can have a maximum length of no more than 3 metres, depending on the draw. Note, in any case, that long sections encourage the accumulation of dirt and are harder to keep clean.

**THE FLUE:**

Further to the general prescriptions for the smoke duct and flue, the flue:

- must only be used for discharging fumes
- must be correctly sized to satisfy the requirements for fume discharging (EN 13384-1)
- should preferably be insulated, in steel with a circular internal section. If rectangular, the corners must have a radius of not less than 20 mm, with aratio of the internal dimensions of <1.5
- must normally be at least 1.5 metres in vertical length
- must have a constant cross section
- must be waterproof and thermally insulated to ensure a good draw
- preferably provide a collection chamber for unburnt residues and condensates
- if pre-existing, must be clean, to prevent fire hazards
- in general, we recommend fitting a tube inside the existing masonry chimney if its diameter is greater than 150 mm.

**INTUBATED SYSTEM:**

Further to the general prescriptions for the fumes duct and flue, the intubated system:

- must operate in negative pressure;
- must be open to inspection;
- must observe local regulations.

**THE CHIMNEY POT** (In every country and specially in France, check on the specific waiver conditions)

- must be anti-downdraught
- must have an internal cross section equivalent to that of the flue and a fumes outlet at least double that of the interior of the flue
- for dual flues (which should be spaced at least 2 m apart) the chimney pot receiving the fumes from the solid fuel appliance or that from the higher storey, must be at least 50 cm higher than the other
- it must extend beyond the back flow zone (in Italy, refer to UNI 10683 point 6.5.8.)
- it must allow for maintenance of the chimney.

**COMBUSTION AIR INTAKE**

The inflow of necessary air for combustion, of air for glass cleaning and heating air renewal must come from the outside

**Sealed stoves can also be installed in passive houses. In this case, the air inlet must be a direct air inlet. The stove takes the air from the outside via the air inlet hole.**

**Install an air intake with an effective surface area (net of the mesh or other protective equipment) at least equal to the cross section of the air inlet hole.**

Connect the air intake to the appliance's air intake with a pipe that may also be flexible. Increase the diameter of the pipe if the pipe is not smooth or if it is necessary due to load losses: assess the load losses.

We recommend that it does not exceed 1 metre in length or include any bends.

If you are not interested in the sealing feature of the appliance, you can create an indirect air intake, even if this is not recommended

Install an air outlet at floor level with an effective surface area (net of the screen or other protections) of at least 80 cm<sup>2</sup> (diameter 10 cm).

To prevent draughts, we recommend installing the intake behind the product or behind a radiator.

Installing it in front of the appliance will create unpleasant draughts.

The air may be drawn from an adjacent room only if:

- the flow is taken from permanent, unobstructed openings communicating with the outdoors
- the air pressure in the adjacent room is never reduced to a level below outdoor pressure
- the adjacent room is not a garage, subject to fire hazard, a bathroom or a bedroom
- the adjacent room is not a shared room in the condominium

In Italy, UNI 10683 provides that ventilation is sufficient even if a pressure difference between the outdoors and indoors of no more than 4 PA is guaranteed (UNI EN 13384-1). The installer who issues the declaration of conformity is responsible for ensuring these conditions.

**USE OF CONCENTRIC PIPES**

Without prejudice to the general instructions, you can use concentric pipes (which provide for the passage of smoke inside and the passage of the combustion air into the external circular ring).

This type of installation only needs one hole in the wall, instead of having one hole for the air intake and one for the smoke discharge.

Examples of possible installations. For the smoke discharge conditions (on roof, etc.) check local regulations for sealed pellet stoves.

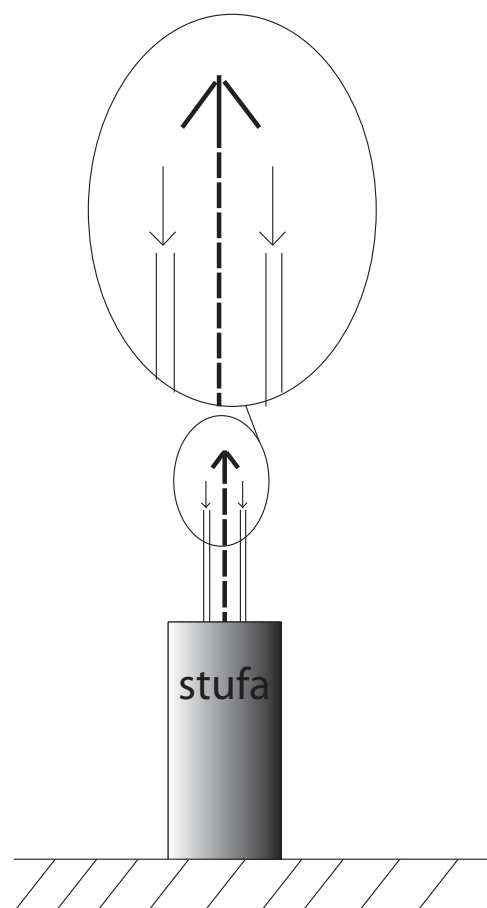

Upper coaxial fumes discharge and air intake

**CHECKING THE ELECTRICAL CONNECTIONS  
(the power socket must be located in an easily accessible position)**

The stove is equipped with an electrical power cord or connection to a 230V 50 Hz socket, preferably with an electromagnetic switch.

Variations in voltage of more than 10% can compromise the operation of the stove.

The electrical system must be compliant; check the operation of the earth in particular.

Edilkamin is not responsible for malfunctions resulting from an improperly earthed system.

The power line must be of adequate section for the power of the appliance.

The power cable must not come into contact with the flue or other hot parts of the stove.

Power up the stove by setting its switch from 0 to 1.

There is a 4 A fuse on the socket with switch located at the rear of the stove.

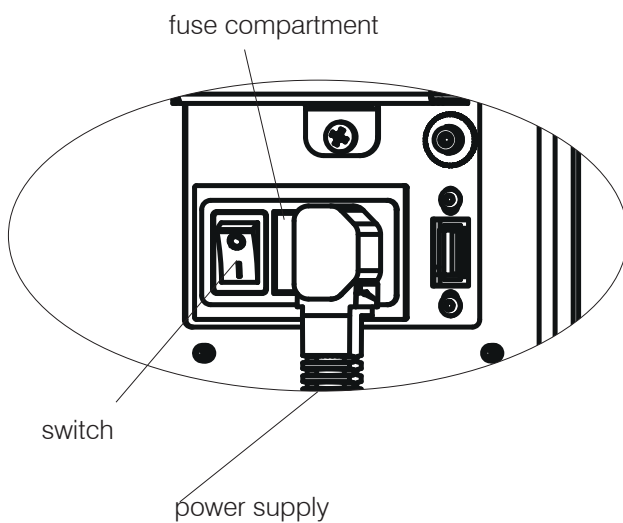

**DUCTING OF HEATING AIR**

To duct the warm air exiting the rear (protected as standard by a grille), you will find several optional extras at your reseller:

- air duct pipe (3 metres, 6 cm diameter)
- "Y" deviation for duct pipe (6 cm diameter)
- various models of ducting vents (Bent, Split, Origami, Sharp).

The instructions for connecting these vents are given in the manual provided with the vents.

**FIRST IGNITION (COMMISSIONING) PHASES**

- Make sure you have read and understood this manual
- Remove all flammable materials from the appliance (manuals, labels, etc.). In particular remove any labels from the glass
- Make sure that the technician performs the first ignition and the first loading of the pellet tank (see “pellet loading”)



On first ignition, there may be a slight smell of paint, which will disappear in a short time.

**FUEL**

Use UNI EN ISO 17225-2 category A1 wood pellets or similar regulatory products with the following characteristics.

- diameter 6 mm
- length 3-4 cm
- humidity < 10 %

For reasons of safety and environmental compatibility, DO NOT burn plastic, painted wood, coal, bark or other such materials in the stove.

Do not use the stove as an incinerator



**Caution**  
Using fuels other than those specified can damage the appliance

**PELLET LOADING**

Gently slide the top until the end stop to load pellet. Open the inner hatch and just pour pellet making sure not to spill it out jamming sliding top telescopic guides. Close the loading hatch and the sliding top.



**Caution**  
When the stove is hot, DO NOT MAKE CONTACT between the pellet bag and the top grille. Use the glove when loading the stove while it is operating and hence hot to the touch. Make sure not to touch the smoke discharge pipe if hot.

\* Check that the tank is closed. A contact will stop the pellet load should the tank remain open



Product can be commissioned only after coverings installation. Switch on the product only after complete installation including coverings. Risk of electric shock from live device parts.

**OPERATION**

Mode	Settable parameters
MANUAL	<ul style="list-style-type: none"> <li>power level</li> <li>ventilation level (if there are two or more fans, they can be adjusted separately)*</li> </ul>
AUTOMATIC	<ul style="list-style-type: none"> <li>desired room temperature</li> <li>ventilation level *</li> </ul>
CRONO	<ul style="list-style-type: none"> <li>desired room temperature, selected per day of the week</li> <li>ventilation level*</li> </ul>

\* by lowering ventilation, the product can also automatically modulate the power to maintain maximum performance and avoid overheating. Where necessary, a safety function is provided: if for reasons of use or installation the set ventilation does not allow the necessary heat dissipation, the maximum ventilation is automatically started.

The product also has the following supplementary functions.

Function	Modes in which it can be activated	What it does
Stand-By	automatic crono	when the desired temperature is reached, the product switches off and then back on again when the temperature drops
RELAX (not provided for some types of products)	manual automatic crono	enables natural convection mode (fan off), thus reducing the power
EASY TIMER	manual automatic	can be used to programme the switching off/on after a set number of hours (maximum 12 hours)





## INTERFACE

The product can be managed alternatively as follows

### STANDARD

- **Bluetooth REMOTE CONTROL:** can be used for all functions, near the product
- **The Mind APP** : useful for all functions at home with direct connection or outside the home with internet connection and registration

If necessary, a few functions can also be managed from a

- **SAVE PANEL:** placed on the product

By purchasing the Edilkamin **optional elements:**

- **VOICE CONTROL SYSTEMS:** Alexa or Google Home

**OPTIONAL ELECTRICAL CONNECTIONS**

On the product (accessible by removing the coating, with the electricity off and only by qualified technicians) a dedicated low voltage terminal block can be found

**-Pin 1-2 = zone 3 ambient input = probe or thermostat of the relative zone**

**-Pin 3-4 = zone 2 ambient input = probe or thermostat of the relative zone**

**-Pin 5-6 = home automation input = commercial telephone dialler or remote On-Off or Thermostat.**

**NOTE:**

The connections must be made by qualified personnel, with the electricity disconnected.

More info for installers on the site.

terminal block example

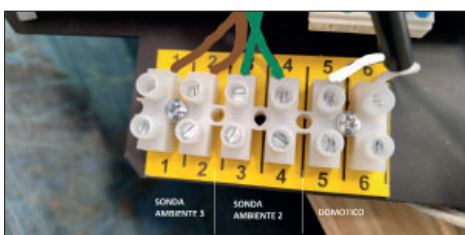

In case of connection of probes or thermostats on the room inputs, the relevant parameters must be set in the Technical Menu of the appliance.

There are two possible modes of operation. The installer can help you choose, according to your needs:

	<b>Thermostat on home automation contact</b>	<b>Thermostat in place of the ambient probe on the electronic board</b>
ACTION	The product turns on/off without any modulation.	the product modulates, goes into stand-by and turns on/off

**REMOTE CONTROL**

The remote control has specific functions for three distinct figures:

- **USER** of the product (operations not protected by password)
- **INSTALLER** (operations with dedicated password because any errors can jeopardise the product's operations and SECURITY)
- **EDILKAMIN TECHNICAL ASSISTANCE CENTRE (TAC)** (operations with dedicated password because any errors can jeopardise the product's operation and SECURITY).

**Characteristics:**

Module for RF transmission and reception with 2.4 GHz frequency - Recommended power supply 3 x AA slimline 1.5 VDC batteries (with at least 1600 mAh capacity).



Risk of explosion if the batteries are replaced with other unsuitable batteries.

**REMOTE CONTROL POWER SAVING**

After 20" of non-use the backlighting decreases and after a further 10" the display switches off. If any button is pressed with the display on, the counter resets. If any button is pressed while the display is off, the display and the backlighting will switch on and the counter will reset.

This only refers to the remote control, not the product itself.

In normal use, the remote control's batteries should last a year. This duration is for illustrative purposes only. Edilkamin and the reseller will not consider claims for battery life under any circumstances.

**If on the initial start-up** the language was not set, the screen for setting the language will appear. Choose the language with the +/- buttons and confirm with OK.



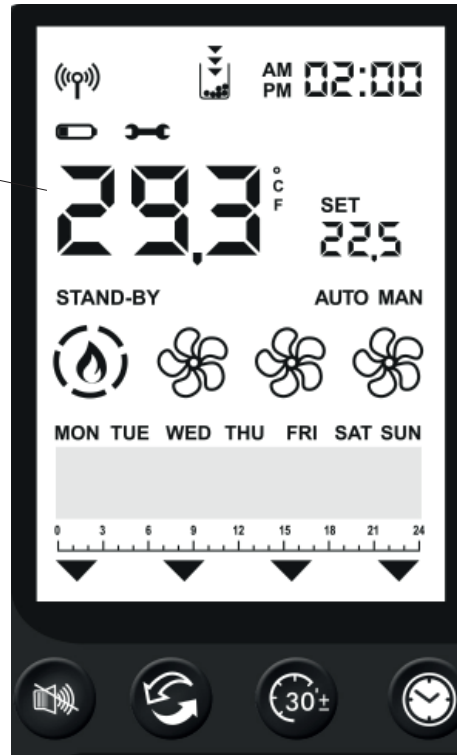

Current room temperature



Target room temperature

 Bluetooth communication present between the product and the PCB. If there is no communication, the symbol disappears.

 On only if the battery is running out.

 Maintenance necessary symbol.

 Appears after a certain number of hours of operation. In some models the symbol may be linked to a fuse problem on the board. In any case, contact the TAC.

 The relative function is active (Relax – airKare – EasyTimer – Crono).

**EasyTimer and Crono cannot be activated simultaneously.**

 Reserve indicator. It switches on if the function is active. The arrows switch on in sequence to signal that the tank must be filled.

 Presence of flame and stove power

POWER ON

POWER LEVEL 1

POWER LEVEL 2

POWER LEVEL 3

POWER LEVEL 4

POWER LEVEL 5





Visualisation of the status of the fan(s).

If the product has not heated up, no symbol will appear.

- FAN OFF: 
- SPEED 1 
- SPEED 2 
- SPEED 3 
- SPEED 4 
- SPEED 5 
- AUTOMATIC 



Indicates that the product has switched off after the target has been reached with stand-by mode active. DOES NOT indicate that the function is enabled.

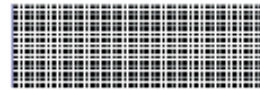

Bottom bar for "Weekly Hour Schedule" and "Messages".



Automatic or Manual mode: the product's air power depends on the room temperature or is set by the user.

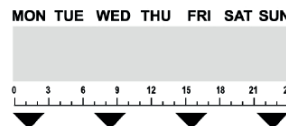

Days of the week and time bar. They only appear if the timer (Crono) has been activated.



Setting. Indicates that the remote control is in the setting mode. The settable value will appear in the bottom bar.



Digits for SET-POINTS. Setting of the various SET-POINTS: temperature, power, fan speed.

**POWER ON/POWER OFF**

These operations will take a few minutes, during which the flame must appear or extinguish. Simply wait without taking any action.

The ON/OFF button is used to manually start the on or off phase.

**During the switch-on,**

the display will show the status (CLEANING; SWITCH-ON; etc.)

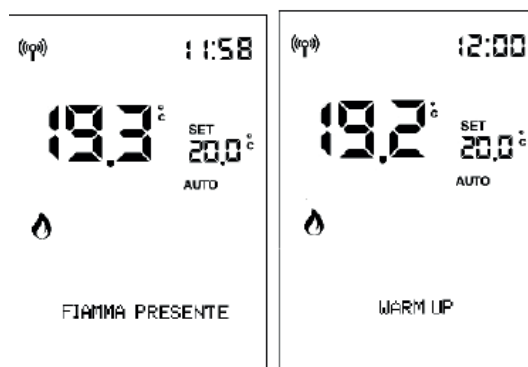
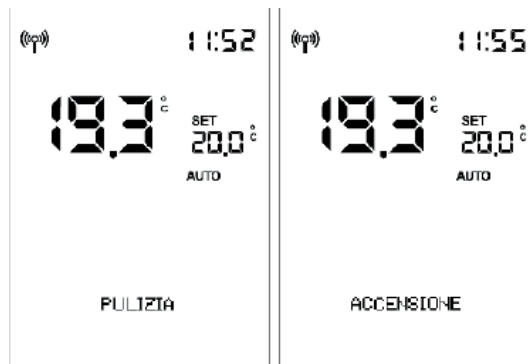

**During switch-off,**

the display shows the message "SHUTDOWN".



**If time programming is active,**

the status and programming are displayed alternately (3 seconds) on the status bar:

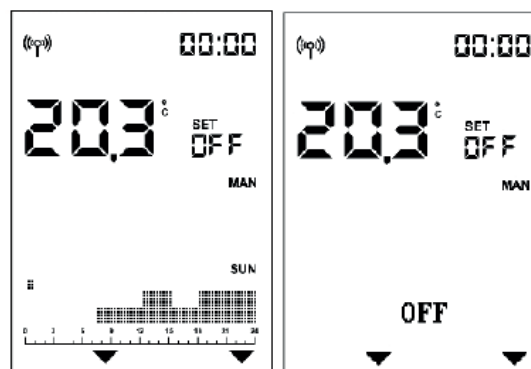

**AUTOMATIC and MANUAL setting**

Press the AUTO/MAN button to switch from manual to automatic mode or conversely.

AUTOMATIC

MANUAL

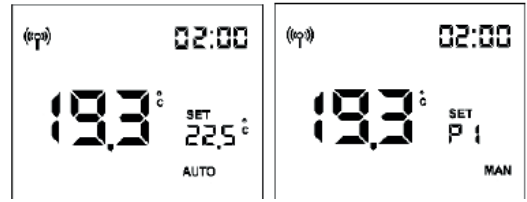

**In AUTOMATIC mode:**

**Setting the room temperature** (read by the remote control, which should be in the room where the product is installed).

Example: press a button and activate the display, then press the  button

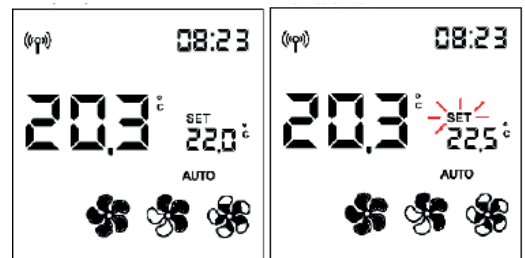

**In MANUAL mode:**

**Setting of the power**

Modify the power level (displayed by the flame symbol) using the “+” and “-” buttons.

For example: press any button and the display will activate, then press the  button

“flame” symbol

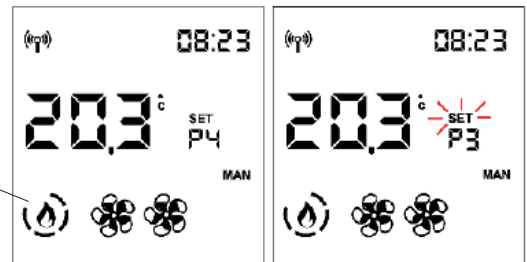



The setting can be confirmed with the  button or by waiting 5” without pressing any button. After confirming, SET will stop flashing.



**NOTE:**

**With the timer active and the product switched off,** neither the temperature nor the power can be adjusted.

**- FAN ADJUSTMENT**

The setting can be made with the stove turned OFF or ON.  
If the backlight is switched off, it can be activated by pressing any button.

Then by pressing the button  or  SET flashes and instead of the environment Set, the indication of the number of the fan being edited appears (F1).

The fan speed can be increased or decreased with  or  in the following sequence:

- 1 -2 - 3 - 4 - 5 - AUTO - for the front fan (1)
- OFF-1-2-3-4-5- AUTO for ducted fans (2 and 3)

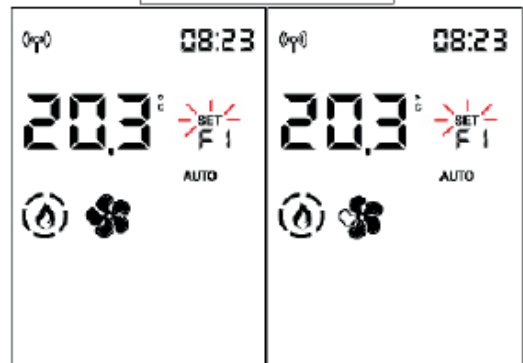
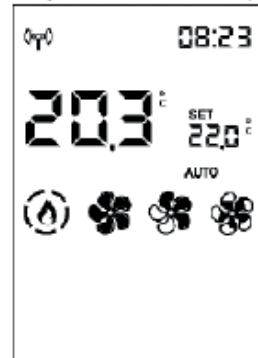

with button 

with button 

You can confirm the setting with the  button and then move to the next fan, if present (only for PLUS ducted versions), otherwise you can exit the fan setting page and "SET" will stop flashing.  
Wait 5" without pressing any button to exit the fan setting, and SET will stop flashing.



**- RELAX FUNCTION**

Natural convection function (without ventilation) with automatic power limiting.

This function is available in all modes: automatic, manual and crono.

Press the  button to activate the Relax function.

Its activation on the display will be signalled by the arrow relative to the Relax button

Again by prolonged pressing of the  button, the function is disabled.

The product reduces its power output and after a few minutes switches the fan off too.

**NOTE:**

While the Relax function is active, it is not possible to increase the power to level P5.

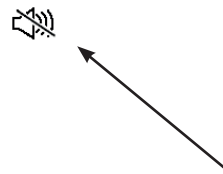
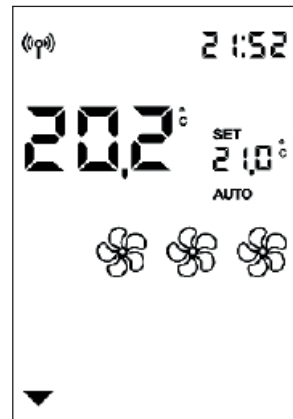

**- AIRKARE FUNCTION**



This function is available as a standard feature on certain models and as an optional feature on other models: check which model you have.

The function, if available, can be activated with the product either on or off, in any mode (except in alarm mode).

The airKare can be activated or deactivated by pressing the dedicated  button

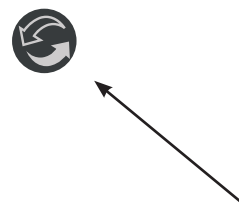
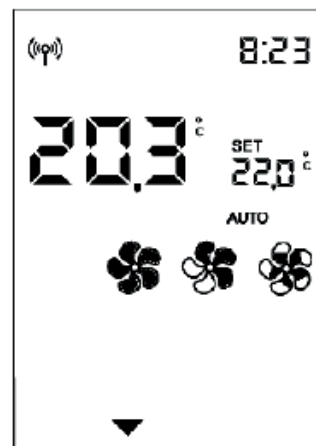

Its activation on the display will be signalled by the arrow relative to the airKare button.

**- EASY TIMER FUNCTION (delayed switching off and on)**

This function switches the product on/off after a set period from activation of the function.

This is convenient if you go to bed and want the product to switch on/off after a few hours (maximum 12 hours).

**The Easy Timer function can be activated by pressing the dedicated button**



By activating the Easy Timer function with the product on, the switch-off time can be set with ½ hour intervals.

By activating the Easy Timer function with the product off, the user sets the switch-on time.

Pressing the OK button or after 5" without pressing any button, the countdown will start with 5-minute intervals.

Example: Switch-ON in 1/2 hours' time.



The bar will continue to show the countdown which decreases until the product switches on or off.

The Easy Timer function can be deactivated by pressing the dedicated button.

The display will show an arrow above the button and the countdown.

To vary the timer before the switching on or off, it must be deactivated and then reset.

## CRONO

**After setting the times, temperatures or power levels in the CRONO MENU,** if the product is in automatic mode, the timer will work at room temperature, otherwise at the power setting.

Pressing the  button allows for switching from Crono in Temperature and Crono to Power and vice versa.



Briefly pressing the  button activates or deactivates the timer (programmed in advance from the app or remote control).

## NOTE

The timer is programmed from the MENU. The timer button is only used to activate/deactivate the function.

**- MENU**

It can be accessed by pressing the  button and the first Menu item will appear.

You can scroll the menu items with the  and  buttons, and enter the item with the  button

The menu items appear in the following order:

- STAND-BY**
- PELLET LOAD**
- CRONO**
- TEMP. CRONO**
- DATE-HOUR**
- LANGUAGE**

The following functions must be taken into account only following indications from the technician.

Therefore, we do not report the complete explanation in this document

- DISPLAY**
- INFO**
- SOFTWARE**
- DATA**
- ALARMS**
- PELLET FALL**
- PELLET SENSOR**
- TECHNICAL MENU**
- SET TEMPERATURE**

The set-point digits contain the progressive number of the menu item, while the status bar includes the description of the menu item in large letters.

**NOTE**

Depending on the version, the order of the items may vary.



**We recommend, at the end of installation and commissioning, to check all the daily operations and useful documents with the technician.**

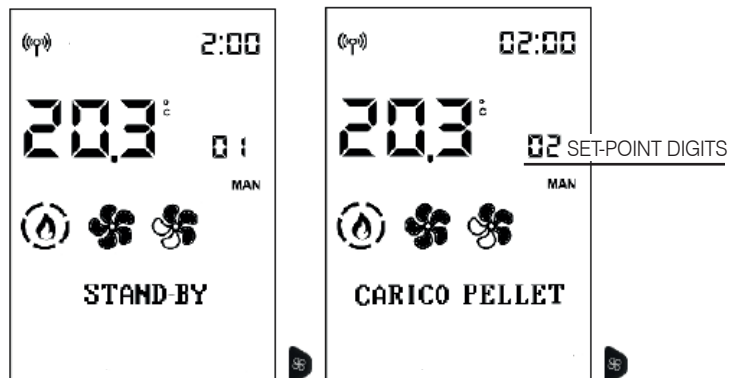



To exit the menu, press 

**STAND-BY**



When the Stand-by function is active, in the automatic and crono modes, the product switches off once the temperature set-point is reached and turns on again when the room temperature drops below the chosen value.

When the Stand-by function is not active, the product sets itself to minimum power when the temperature set-point is reached.

To access the function from the main menu (as indicated in the Menu section above), press the MENU button.

You can scroll the menu items with the  and  buttons, and enter the item with the  button

After entering the Stand-by function, the display will show the name of the function on the first line of the status bar and the current value on the second line (OFF if deactivated, ON if active).

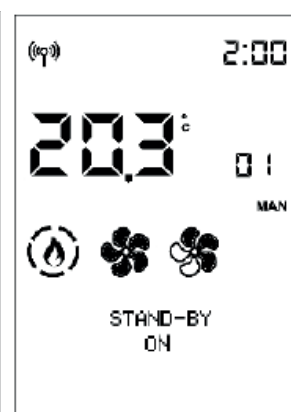
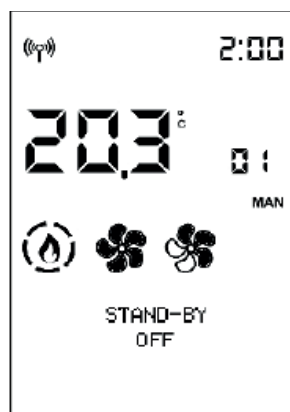

The  and  buttons can be used to modify the value from Off (function deactivated) to On (activated) and the  button can be used to confirm.

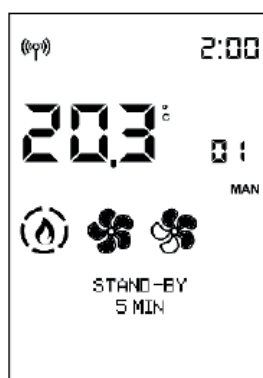

Pressing the  button with the value ON activates the function and the display will propose to choose how many minutes must pass before the device switches off in stand-by mode.

(example 5 minutes)



The  and  buttons can be used to modify the time, and the button  to confirm

Pressing the  button automatically takes you to the first level.

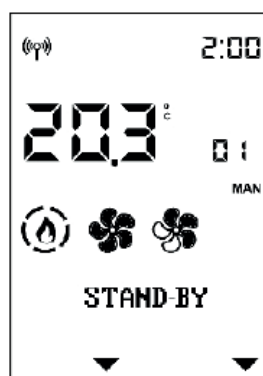



**PELLET LOADING**

Allows you to load pellets after the pellet tank has been completely emptied.

Useful for the technician during the initial start-up.





Available only in the OFF status. Any attempt to activate the function in other statuses will not be allowed.

To access the function from the main menu (as indicated in the Menu section above), press the MENU button.

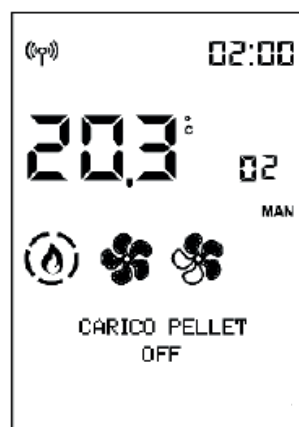
You can scroll the menu items with the  and  buttons, and enter the item with the  button

Once you have entered the **PELLET LOAD** function, the display shows the name of the function on the first line of the status bar and the current value on the second line (OFF if disabled, ON if enabled).









The  and  buttons can be used to modify the value from Off (deactivated) to On (activated) and conversely, while the  and  buttons are used to adjust it.

Pressing the  button automatically takes you to the first level.

**- CRONO**



To access the function from the main menu (as indicated in the Menu section above), press the MENU button.

You can scroll the menu items with the  and  buttons, and enter the item with the  button

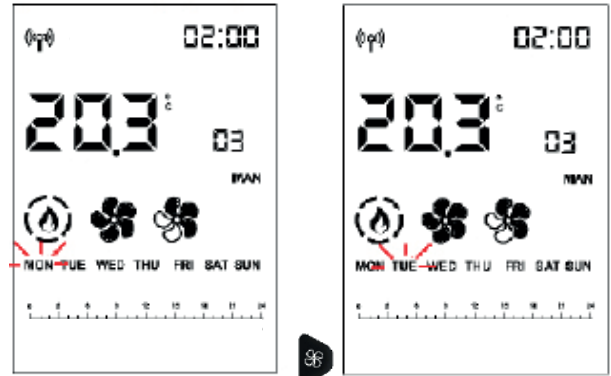

Choose the day of the week by scrolling the  and  buttons (you will simultaneously see the programme for that day) and confirm with the  button.



The cursor (rectangular) positions itself on 00:00.  
The time at the top RH shows the start of the time slot

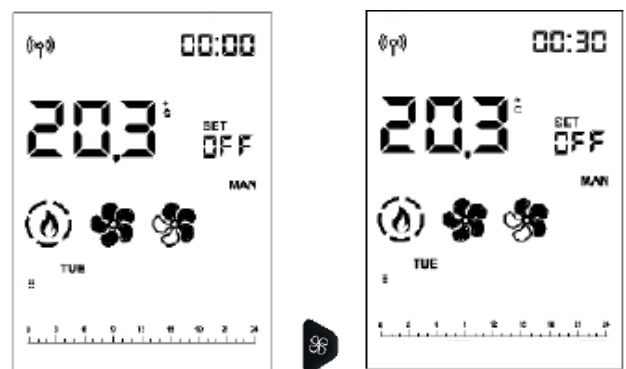

Use the  and  buttons to scroll the time with 1/2-hour steps, by moving the cursor and displaying the pre-set level.



The  and  buttons can be used to modify the temperature levels (OFF – T1 and T2) or the power levels (OFF – P1 and P5).



After reaching 23:30 you must go backwards.

If you shift by pressing and holding the  or  buttons for more than 2", you copy the previous level onto the next level with a 1/2 h frequency per second.

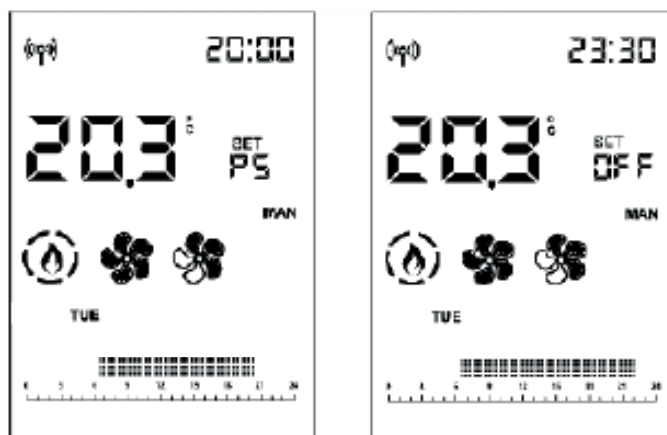

The level can be copied also with backward shifts.



After setting the entire day, confirm with the  button







The copied day of the week flashes and you can shift to the next day using the  and  buttons

Confirm with the button



Briefly pressing the  button allows you to exit the programming mode, but the programme will not activate.

To activate it, you must briefly press the  button again from the main page.

## NOTES



The switching on and off of the product can be forced with the timer active, by pressing the ON/OFF button for 2".

Only with the Stand-by function active will the product switch off once the set temperature has been reached.



**TEMP. CRONO (T1-T2)**

Temperature setting for timer T1 – T2



To access the function from the main menu (as indicated in the Menu section above), press the MENU button.

You can scroll the menu items with the  and  buttons, and enter the item with the  button

After entering the T1-T2 function, the display will show the name of the function on the first line of the status bar and the current value of T1 on the second line. T1 is the lowest temperature, T2 the highest.

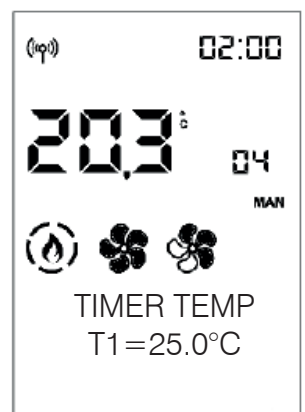
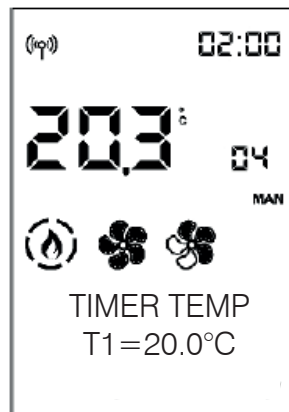
Use the  and  buttons to move to set-point T2 setting.



Modify the values with the  and  buttons and confirm with the  button

Pressing the  button automatically takes you to the first level.



**DATE-HOUR**

Can be used to set the current date and time.

To access the function from the main menu (as indicated in the Menu section above), press the MENU button.

You can scroll the menu items with the  and  buttons, and enter the item with the  button

After entering the Date-Time function, the display will show the name of the function on the first line of the status bar and the current value of the first setting (12/24 hours) on the second line.

You can switch from 12 to 24 hours using the  and  buttons and confirm with the  button



You reach the AUTO SUMMER TIME item (OFF if deactivated ON if activated)

You reach the WEB SYNC item (OFF if deactivated ON if activated)

At the end the item SET HOUR will appear and it will be possible to modify the hours first with buttons + and - and confirm with the  button

The minutes will then flash



The hours will then flash and can be modified using the  and  buttons, then confirmed with the

 button

The minutes will then flash.





If the product is connected to the cloud, the date and time can be set from the web.

If the product is connected to a smartphone, the date and time can be set using the app.

**LANGUAGE**

Selects the language.



To access the function from the main menu (as indicated in the Menu section above), press the MENU button.

You can scroll the menu items with the  and 

buttons, and enter the item with the  button

After entering the Language Menu item, the name of the function appears on the first line of the status bar and the current value on the second line (ENGLISH)



Modify the language using the  and  buttons then exit and confirm with the  button

Pressing the  button automatically takes you to the first level.

**The following functions must be taken into account only following indications from the technician. Therefore, we do not report the complete explanation in this document.**

**DISPLAY**

Allows you to change the brightness of the display and an acoustic signal when the keys are pressed

**BRIGHTNESS ON**

Indicates the backlight percentage of the display.  
You can switch from one percentage to the other with buttons + and - and confirm with OK button

**STBY BRIGHTNESS**

Indicates the backlight percentage of the display before entering energy saving mode

**TIME ON**

Indicates the time the display remains illuminated

**STANDBY TIME**

Indicates the amount of time the display remains illuminated before entering power saving mode

**BEEP**



Allows to enable an acoustic signal when the buttons are pressed (OFF if deactivated ON if activated)

**INFO**

These readings should only be done when requested by the technician.

The technician understands the diagnostic meaning of the messages and values, and may ask you to read them to him/her if you experience problems.

To access the function from the main menu (as indicated in the Menu section above), press the MENU button.

You can scroll the menu items with the  and  buttons

Pressing the  button automatically takes you to the first level.

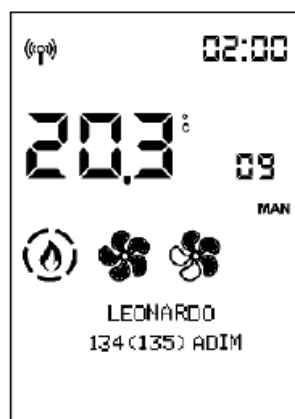
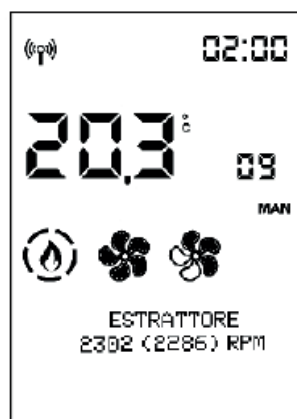
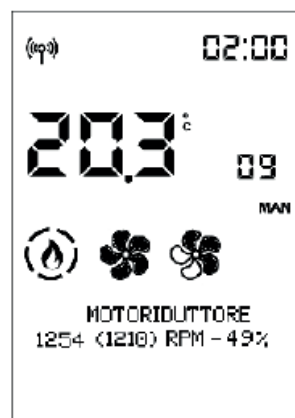
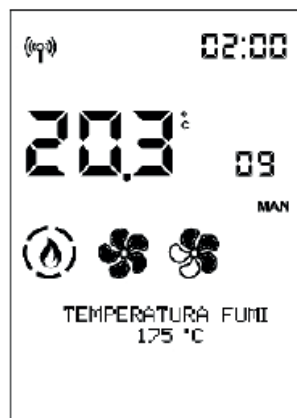

**- INFO (info for INSTALLER continues)**

They provide instant situation values.

**Flue temperature** indicates the value of the temperature read inside the product. To be read only under the guidance of the Technical Assistance Centre

**Auger motor**: indicates the speed set and read. Useful for understanding any anomaly in the motor that loads the pellets. To be read only under the guidance of the Technical Assistance Centre

**Extractor**: indicates the speed set and read. Useful for understanding any anomaly in the engine that creates depression in the combustion chamber. To be read only under the guidance of the Technical Assistance Centre

**Leonardo**: indicates the target value set and read. To be read only under the guidance of the Technical Assistance Centre

**Fan1**: indicates the output voltage. To be read only under the guidance of the Technical Assistance Centre

**Ignition plug (spark plug)**: indicates whether the ignition component is on or off. Useful in the ignition phase to understand functionality.

**Home automation contact**: indicates whether ON or OFF. Useful for understanding functionality.

**Radio signal**: indicates the signal strength in milliwatt decibels. Admissible values from 0 to -95dB

**- SOFTWARE**



Indicates:

- the firmware version of the electronic board (basic board)
- the firmware version of the control panel
- the database (associated by the Technical Assistance Centres with the products)



To be read only under the guidance of the Technical Assistance Centre



**DATA**

Information of the product's operation log can be scrolled with the  and  buttons

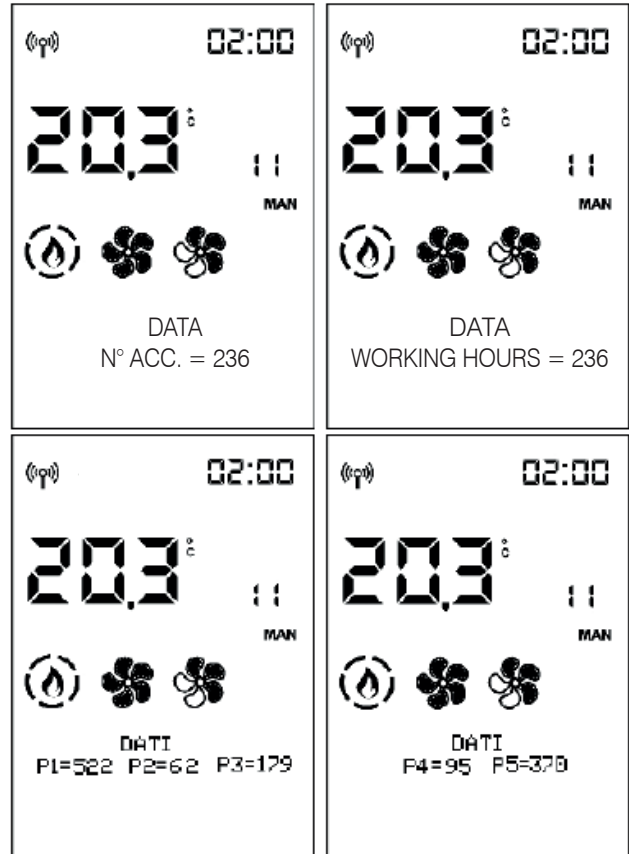

To access the function from the main menu (as indicated in the Menu section above), press the MENU button.

You can scroll the menu items with the  and  buttons, and enter the item with the  button



Pressing the  button automatically takes you to the first level.

**ALARMS**

Information of the product's operation log can be scrolled with the  and  buttons.

Readings to be carried out under the guidance of a technician. The meaning of the abbreviations is in the dedicated paragraph  
The alarms are arranged from the most recent to the oldest.



Exit with the button 

**PELLET FALL**

Allows to set the auger motor in continuous cycle or in steps. To be carried out **ONLY UNDER THE GUIDE OF A TECHNICIAN**.

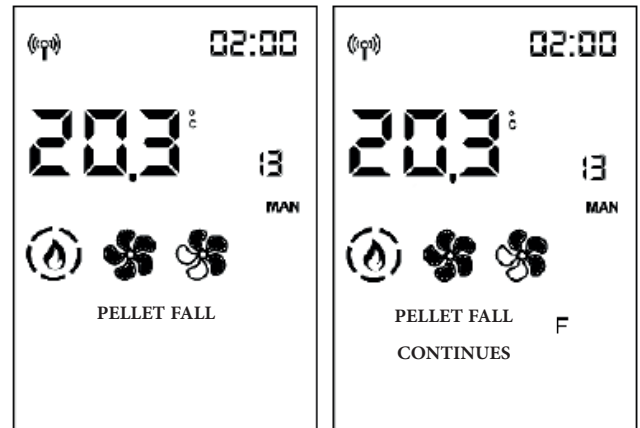

**PELLET SENSOR**

Allows you to set ON or OFF of the pellet level sensor.

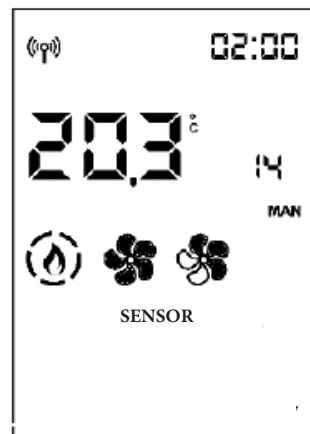

**TECHNICAL MENU (for TECHNICIANS ONLY)**

Accessible only by technicians with password (1111). Once the password has been entered, confirm with the  button

If you enter with the installer password (1111) you will only access the following installer parameters/settings:

- **FLAME TYPE**
- **PELLET TYPE**
- **PARAMETERS**



**- FLAME TYPE (for the TECHNICIAN ONLY)**

In correct installation conditions, with the Service Centre parameters appropriately adjusted, with quality pellets, the intensity of the flame is adjusted:

- STANDARD
- ECO
- PLUS

After entering the Technical Menu, the first item, "FLAME TYPE", will appear

You can enter the Flame Type setting using the  button

while the  and  buttons can be used to modify the correction value.

Pressing the  button automatically takes you to the first level.





**NOTES**

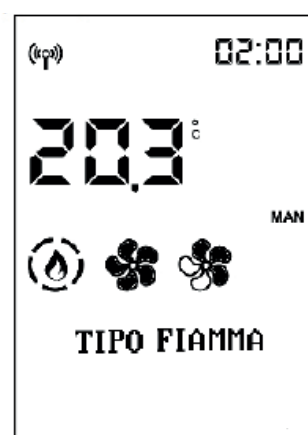

inappropriate changes can cause the product to seize up

Information on how to use these functions is only available to technicians in the appropriate web area.



**- PELLET TYPE**

You can scroll the Technical Menu items with the  and  buttons until you reach "PELLET TYPE"

Enter the Pellet Type (%) setting with button  and the value can be modified with button  and 

Use the  button to exit and return to the Technical Menu

In correct installation conditions, with the Service Centre parameters appropriately adjusted, with quality pellets, the pellet load is adjusted



MEDIUM

HIGH

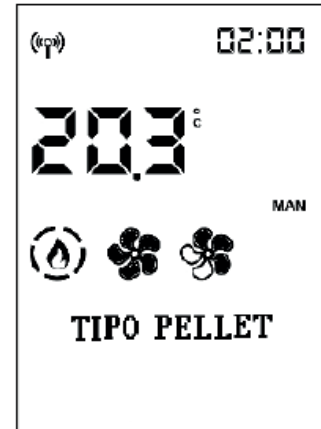
LOW





**- PARAMETERS**

Scroll through the items of the Technician Menu with buttons  and  up to the item "PARAMETERS".

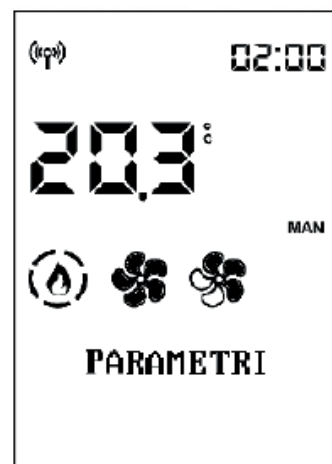
You enter the Parameters with button , the first parameter is displayed.



Scroll through the parameters with  and  and the value can be modified with buttons  and .

If you entered the Technician Menu with the Installer Password, only the Installer parameters appear, otherwise all the parameters appear.

**PARAMETERS (continue PARAMETERS for INSTALLER)**

**SENS. PLT LEVEL:** enables or disables the possibility for the end customer to view and choose the status of the pellet reserve indicator

**AIRKARE FUNCTION:** allows to select IF Airkare is active and on which room size (SMALL, less than 30 m<sup>3</sup>, or BIG) or not active (OFF)

**AIRKARE RESET :** allows to reset the working hours of airKare

**DUCTING 2:** allows you to activate the speed of the ducting fan at maximum (ON-OFF)

**DUCTING 3** allows you to activate the speed of the ducting fan at maximum (ON-OFF)

**NUMBER OF FANS:** enables or disables the possibility for the end customer to operate the fan if present.

**ROOM INPUT:** allows to choose which item the end customer reads and adjusts on the Home display. It depends on the type of plant:

- PROBE: room probe, standard in the product
- THERMOSTAT: enables the thermostat, which can be installed in place of the room probe.

**ROOM2/CYIL.INPUT:** defines the item to be enabled according to the connected component.

- NO INPUT: default
- PROBE
- THERMOSTAT

**IN. AMB3/CYL/SE:** defines the item to be enabled according to the connected component.

- NO INPUT: default
- PROBE
- THERMOSTAT

**CRONO SYNCHR.:** synchronises the timer

**UNPAIR BLUETOOTH:** enable

**SAVE PANEL**



SAVE PANEL can temporarily make up for the absence of a remote control or smartphone, or other product management systems.

Controls the product starting from the pressing of the buttons.

When the remote control or smartphone re-establishes the communication and sends a command to the product, the remote control or smartphone will once again resume control of the product.

The display will ONLY appear if the product is controlled via the SAVE PANEL.

**FUNCTIONS**





**To switch on the product:** press the On-Off button for a few seconds.

**To set the power level with the product on:** press the "power" button once. Pressing it repeatedly will cause the power to increase, with the following setting appearing on the display: "P1" – "P2" – "P3" – "P4" – "P5" – "P1" – "P2" – ... The ventilation of all room fans will automatically follow the product's power level without it being possible to adjust them.

**To switch off the product:** press the On-Off button for a few seconds.

**To unlock the product that has been locked due to an alarm:** press the On-Off button for a few seconds.

The three LEDs on the left indicate the status of the product associated with the display.

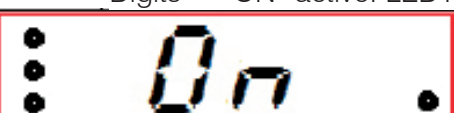
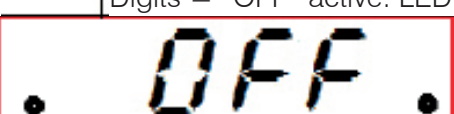
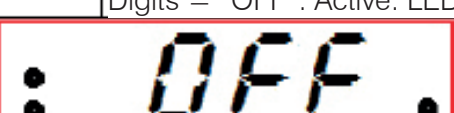
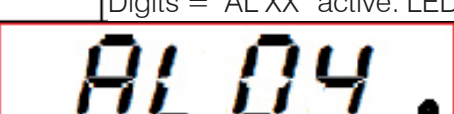
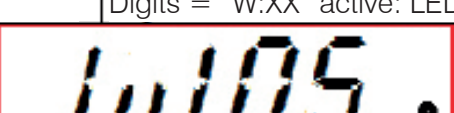
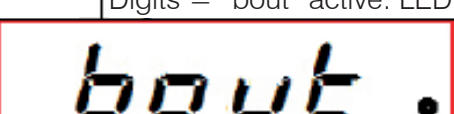
Panel without control unit	Active: LED1 (network present)	
Stove off	Digits = "OFF" active: LED1	
Stove being switched on	Digits = "ON" active: LED1 and LED2	
Stove running	Digits = "ON" active: LED1, LED2 and LED3	
Stove in cleaning mode in work mode	Digits = "ON" active: LED1, LED2, LED3 and LED4	
Stove cooling	Digits = "OFF" active: LED1 and LED2	
Stove cooling	Digits = "OFF". Active: LED1, LED2 and LED3	
Stove in alarm mode	Digits = "AL XX" active: LED1	
Stove in warning mode	Digits = "W:XX" active: LED1	
Stove off due to blackout	Digits = "bout" active: LED1	



**Before doing any maintenance, disconnect the appliance from the mains.  
Regular maintenance is essential to keep the appliance in good working order.  
Failure to service the product properly will prevent it from working properly.  
Any problems due to failure to service the stove will void the warranty.**

**DAILY MAINTENANCE**

These jobs should be done with the product off, cold and preferably disconnected from the mains.

A suitable vacuum cleaner is required.

The entire procedure takes just a few minutes.



**Using the stove without cleaning the burning pot can cause the gas in the combustion chamber to ignite....leading to burst/glass breakage.**

1. Open the combustion chamber door using the removable handle provided.
2. The burning pot slips into position in its housing. Empty the ash tray and burning pot into a non-flammable container (the ashes may still contain embers and/or hot parts) or vacuum if cold. Vacuum out the interior of the combustion chamber, the bed, and the compartment around the burning pot into which the ash falls.
3. Scrape the burning pot with the scraper and clean out any obstructed holes.
4. If necessary, clean the glass when cold using a dedicated product (e.g. Glasskamin), which your dealer should have.

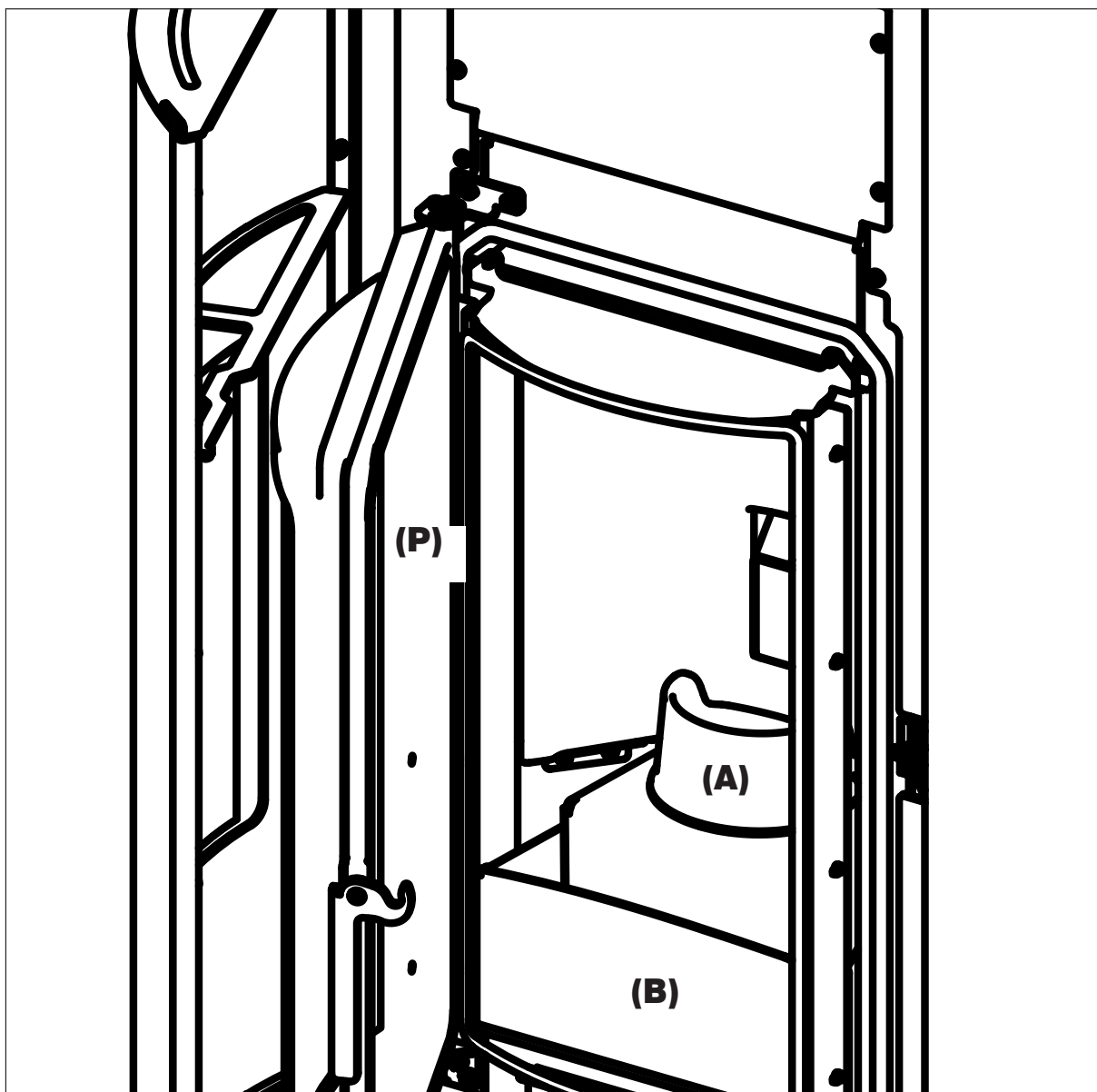

- Do not dump the cleaning residue into the pellet tank.
- Make sure that the ash tray, once re-mounted, is properly positioned in its housing, if not the glass may break by hitting it.
- Ensure that the burning pot is properly positioned in its housing following maintenance, otherwise the stove may have problems igniting.

**SEASONAL MAINTENANCE**

**(to be carried out by the technical assistance centre)**

This consists of cleaning the stove inside and out.

**If the product is used intensively, we recommend cleaning the fumes duct and flue every 3 months.**

You should clean the chimney system at least once a year (check local regulations for details).

If you fail to regularly clean and inspect the system, there is an increased risk of the chimney pot catching fire.

We recommend against using compressed air to clean the combustion air inlet.

Seasonal maintenance must be performed on a regular basis by an authorized technician according to local and national regulations.

**SUMMER SHUTDOWN**

During the period of disuse, keep the stoves doors, hatches and lids closed.

We recommend emptying out the pellet tank.

**SPARE PARTS**

For any spare parts, contact your dealer or technician. Using non-original spare parts may damage the appliance and relieves Edilkamin of all liability for damage resulting such use.

**Do not make unauthorised modifications**

**DISPOSAL**

At the end of its service life, dispose of the product as required by regulations.

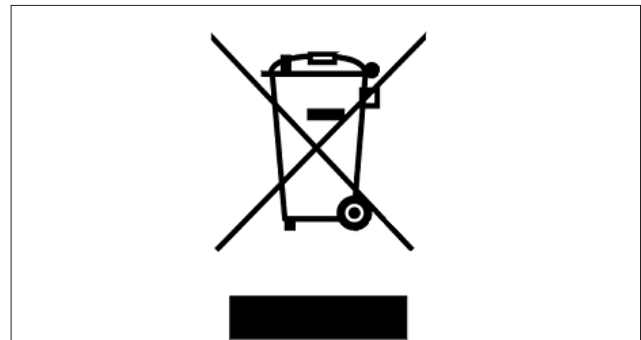

In accordance with art. 26 of Legislative Decree no. 49 of 14th March 2014, "Implementation of Directive 2012/19/UE on the disposal of electrical and electronic devices (RAEE)".

The crossed-out dustbin symbol displayed on equipment or its packaging indicates that the product at the end of its life must be collected separately from other waste.

At the end of its useful life, the user should therefore deliver the product to a suitable local sorted collection centre for electrical and electronic devices.

Sorted collection for recycling, treatment and environmentally compatible scrapping contributes to the prevention of negative effects on the environment and health, and promotes the re-use and recycling of the materials of which the equipment is made.

In case of an alarm, an alarm code will appear instead of the room temperature.

While the product switches off, the status bar will alternately show "OFF" in large letters and the description of the alarm in small letters.

If the alarm occurred with the timer active, only the timer's activation arrow will remain displayed, while the day's time schedule will disappear.

Once the switch-off sequence terminates, only the alarm description will remain.

If problems occur, the product shuts itself off automatically.

The display will show the reason (see below).

Do not disconnect from the power supply.

To restart the product, wait for the switch-off sequence to terminate and then press the ON/OFF button  of the remote control or the simplified switch-on button.

Before starting the product up again, check the reason for the shutdown and CLEAN the burning pot.

The product is equipped with the necessary safety devices but, if the burning pot is not cleaned regularly as explained above, ignition may involve a slight detonation. If white smoke forms in the combustion chamber for a long time, disconnect the mains supply and wait 30 minutes before opening the door and emptying out the burning pot.

**SHUTDOWN MESSAGES AND THEIR SOLUTIONS:**

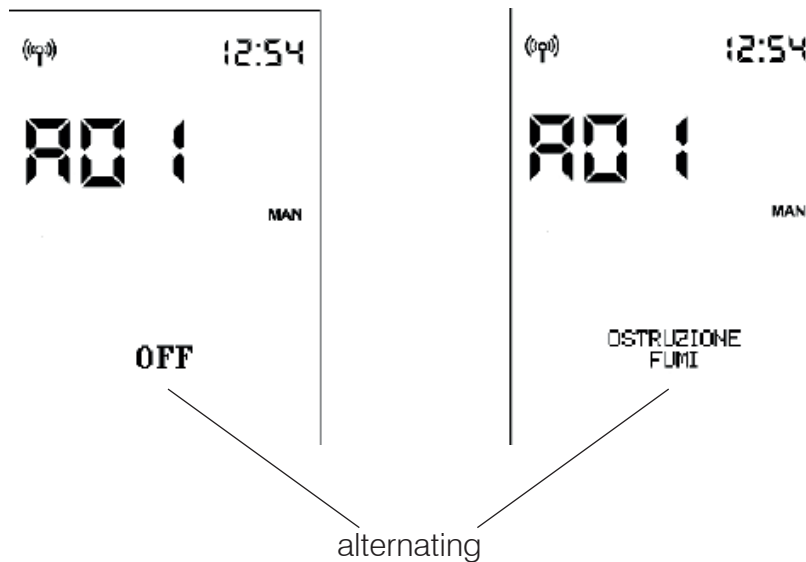

MESSAGE	PROBLEM	SOLUTION
<b>A01</b>	displays when the combustion air intake is below the set level	<ul style="list-style-type: none"> <li>• Check that the combustion chamber door is closed</li> <li>• Check the regular maintenance of the product</li> <li>• Check that smoke discharge and combustion air ducts are clean.</li> </ul>
<b>A02</b>	displays when the logic board is not detecting the right fumes fan speed	<ul style="list-style-type: none"> <li>• Contact the technician</li> </ul>
<b>A03</b>	displays when the thermocouple detects a fume temperature lower than the set value and interprets this as the absence of flame	<ul style="list-style-type: none"> <li>• Check that there are pellets in the tank</li> <li>• Contact the technician</li> </ul>
<b>A04</b>	displays when ignition times out unsuccessfully	<p>There are two possibilities: NO flame:</p> <ul style="list-style-type: none"> <li>• Check that the burning pot is seated properly and clean</li> <li>• Check that there are pellets in the tank and burning pot</li> <li>• Try switching it on with a solid ecological igniter (contact the technician beforehand and follow the instructions of the igniter supplier very carefully).</li> </ul> <p>The operation must be regarded purely as a trial under the technician's guidance.</p>
<b>A05</b>	Shutdown due to air flow rate sensor breakage	<ul style="list-style-type: none"> <li>• Contact the technician</li> </ul>
<b>A06</b>	displays when the logic board determines that the fumes thermocouple is broken or disconnected	<ul style="list-style-type: none"> <li>• Contact the technician</li> </ul>
<b>A07</b>	Shut-down due to exceeding maximum fumes temperature.	<ul style="list-style-type: none"> <li>• Check the type of pellet (contact the technician if in doubt)</li> <li>• contact the technician</li> </ul>
<b>A08</b>	Switching OFF due to excessive overheating of the product	<ul style="list-style-type: none"> <li>• see A07</li> </ul>
<b>A09</b>	Shutdown due to gearmotor failure.	<ul style="list-style-type: none"> <li>• Contact the technician</li> </ul>
<b>A10</b>	Switching OFF due to circuit board overheating.	<ul style="list-style-type: none"> <li>• Contact the technician</li> </ul>
<b>A11</b>	Switching OFF due to the intervention of the safety pressure switch.	<ul style="list-style-type: none"> <li>• Ensure the product and flue are clean</li> <li>• Contact the technician</li> </ul>

MESSAGE	PROBLEM	SOLUTION
<b>A12</b>	Room temperature probe failure. The product is operating in manual mode.	<ul style="list-style-type: none"><li>• Contact the technician</li></ul>
<b>A13</b>	Ducting room temperature probe (if present) fault. The product is operating in manual mode.	<ul style="list-style-type: none"><li>• Contact the technician</li></ul>
<b>A14</b>	Ducting room temperature probe (if present) fault. The product is operating in manual mode.	<ul style="list-style-type: none"><li>• Contact the technician</li></ul>
<b>A20</b>	Gearmotor TRIAC fault switch-off	<ul style="list-style-type: none"><li>• Contact the technician</li></ul>

**MESSAGES WHICH DO NOT SHUT THE STOVE DOWN, BUT ARE SIMPLY WARNINGS****LOW REMOTE CONTROL BATTERY LEVEL:**

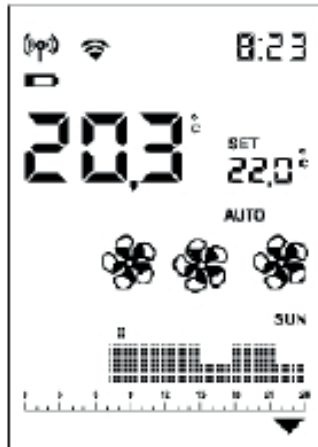

The battery symbol displays on the remote control display if the battery is low.

**MAINTENANCE:**

A spanner symbol will appear on the display after 2,000 hours of operation.

The product is working, but it must be serviced by an authorised Edilkamin technician.

**LACK OF COMMUNICATION:**

In case of a prolonged lack of communication between the stove and the remote control, the Bluetooth transmission icon  will disappear as well as the icons transmitted by the circuit board to the remote control. Only the room temperature  will be present if there is a connection between the circuit board and the Wi-Fi router.



The Wi-Fi transmission icon  will be present if there is a connection between the circuit board and the Wi-Fi router.

**PELLETS RESERVE INDICATOR:**

The function is only available if the pellet level sensor is installed and has been activated.

When the level sensor intervenes, the circuit board emits a single "beep" (in any switch-on or work status) and the moving reserve symbol will appear on the display.

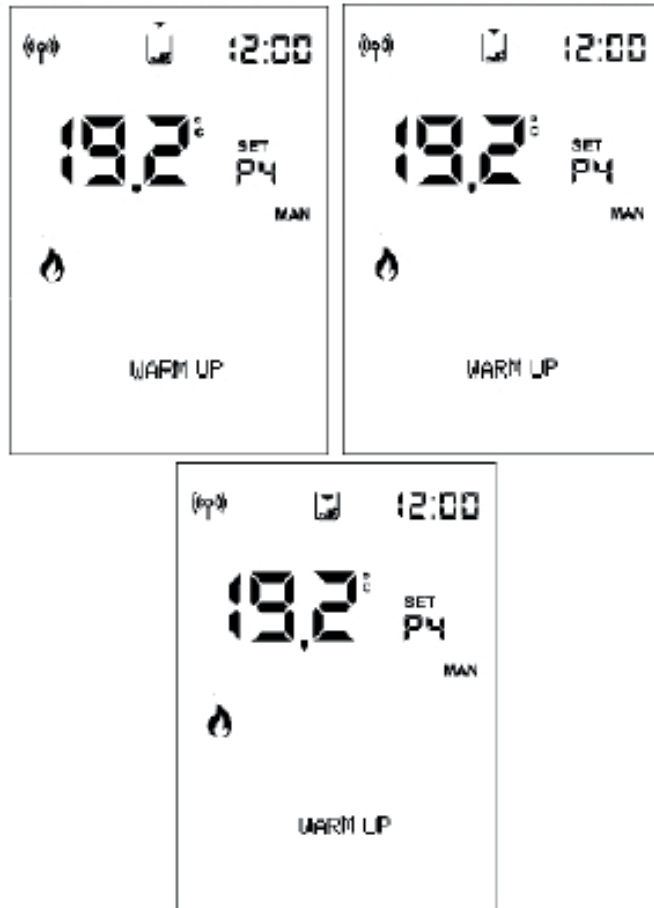

The arrows will light up in sequence to signal the need for pellet loading.



The ignition frequency is roughly 0.5 seconds.



After an interval of roughly 20/30 minutes, which varies depending on the model, the stove switches off due to a shortage of pellets.

If the user reloads the stove before the start of the switch-off procedure, the symbol disappears and the stove resumes its normal operation.

If the user fails to reload the stove before the start of the switch-off procedure, the stove switches off and the tank symbol remains steady lit with the 3 arrows on until the next reloading operation.

When the reserve symbol is present, the stove cannot be restarted.

After reloading the pellets, the stove must be restarted manually.

If the pellets are reloaded and there is an ignition request coming from the timer, the stove will restart.

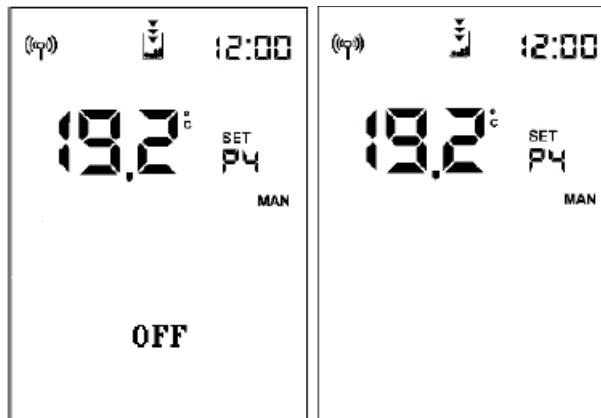

If the sensor intervenes:

- with the stove OFF or in Initial Cleaning mode (following manual emptying of the tank), the final symbol will immediately appear and the stove cannot be switched on;
- during the ignition phase, the ignition sequence will be completed even if it lasts more than the 20/30 minutes of residual autonomy.

If the pellets are not reloaded, the stove will then switch off.

During a switch-off following a **BLACKOUT**, the display will alternately show the words “Black-Out” and “OFF”. Once the switch-off has been completed, the product will remain off and “Black-Out” will appear.

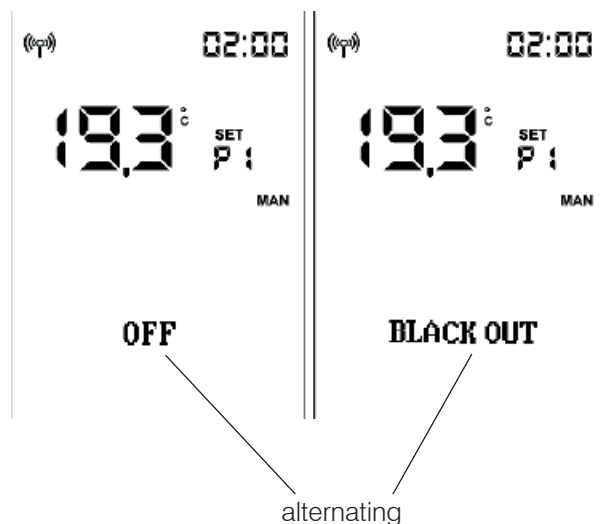







**EDILKAMIN**  
TECNOLOGIA DEL FUOCO

[www.edilkamin.com](http://www.edilkamin.com)

cod. 942163-GB

09.23/C