

INSTALLER MANUAL

Pellet Stove







©2018 CADEL srl | All rights reserved - Tutti i diritti riservati

SFERA³ 11KW - PRINCE³ 11KW- GLOBE AIRTIGHT
SFERA³ PLUS 11KW - SIRE³ PLUS 11KW - DOGE³ PLUS 11KW -
PRINCE³ PLUS 11KW - ELISE³ PLUS 11KW - VEGA AIRTIGHT - TREND AIRTIGHT
VENUS³ PLUS 12,5KW - JOY AIRTIGHT

SUMMARY

1	MANUAL SIMBOLOGY.....	3
2	PACKAGING AND HANDLING.....	3
2.1	PACKAGING	3
2.2	REMOVING THE STOVE FROM THE PALLET	3
2.3	STOVE HANDLING.....	4
3	CHIMNEY FLUE	4
3.1	INTRODUCTION	4
3.2	CHIMNEY FLUE.....	4
3.3	TECHNICAL FEATURES.....	5
3.4	HEIGHT-DEPRESSION.....	6
3.5	MAINTENANCE.....	6
3.6	CHIMNEY POT.....	6
3.7	CHIMNEY COMPONENTS	7
3.8	CHIMNEY FLUE CONNECTION.....	7
3.9	EXAMPLES OF CORRECT INSTALLATION.....	8
4	COMBUSTION AIR.....	10
4.1	EXTERNAL AIR INLET.....	10
4.2	COMBUSTIBLE AIR INLET FOR SEALED-CHAMBER INSTALLATION	11
4.3	COMBUSTIBLE AIR INLET FOR SEALED-CHAMBER INSTALLATION	12
5	INSTALLATION.....	12
5.1	INTRODUCTION	12
5.2	OVERALL DIMENSIONS	13
5.3	GENERAL INSTALLATION.....	21
5.4	FRONTAL PANEL ASSEMBLY (VEGA/TREND/PRINCE ³ / PRINCE ³ PLUS MODELS).....	21
5.5	FRONTAL PANEL ASSEMBLY (VEGA STONE MODEL).....	21
5.6	TILE ASSEMBLY (SIRE ³ PLUS MODEL).....	22
5.7	PANELS ASSEMBLY (SFERA ³ /SFERA ³ PLUS MODELS).....	23
5.8	PANELS ASSEMBLY (VENUS ³ PLUS MODEL)	23
5.9	FRONT PANEL ADJUSTMENTS (ELISE ³ PLUS MODEL).....	25
5.10	STOVE DOOR REMOVAL/INSTALLATION	25
5.11	CONNECTION TO THE EXTERNAL THERMOSTAT	26
5.12	ELECTRIC CONNECTION	26
5.13	STOVE CALIBRATION AND DEPRESSION MEASUREMENT ...	27
5.14	HOT AIR DUCTING SYSTEM (VEGA/TREND/SIRE ³ PLUS/DOGE ³ PLUS/SFERA ³ PLUS/ELISE ³ PLUS/PRINCE ³ PLUS MODELS).....	28
5.15	HOT AIR DUCTING SYSTEM (VENUS ³ PLUS / JOY AIRTIGHT)	29
5.16	USING THE STOVE WITHOUT DUCTING.....	32
6	SPECIAL MAINTENANCE	32
6.1	INTRODUCTION	32
6.2	FEED SCREW MAINTENANCE.....	32
6.3	FUME CHAMBER AND FUME PASSAGES CLEANING	33
6.4	FUME CONDUIT CLEANING.....	37
6.5	FUME FAN CLEANING	38
6.6	ROOM FAN CLEANING	38
7	IN CASE OF ANOMALY.....	39
7.1	PROBLEM SOLVING	39
8	TECHNICAL DATAS	42
8.1	FUSE REPLACEMENT	42
8.2	FEATURES	43

1 MANUAL SIMBOLOGY

	USER
	AUTHORISED TECHNICIAN (ONLY to interpret or the Stove-manufacturer or the Authorized Technician of Technical Assistance Service approved by the Stove-manufacturer)
	SPECIALIZED STOVE-REPAIRER
	CAUTION: READ CAREFULLY THE NOTE
	CAUTION: DANGER OR IRREVERSIBLE DAMAGE POSSIBILITY

- The icons with the stylized figures indicates whom the subject dealt in the paragraph is addressed to (between the User and/or the Authorized Technician and/or the Specialized Stove-repairer).
- WARNING symbols indicates an important note.

2 PACKAGING AND HANDLING

2.1 PACKAGING

- The packaging is made up of recyclable cardboard boxes according to RESY standards, recyclable expanded polystyrene inserts and wooden pallets.
- All packaging materials can be re-used for a similar use or eventually discharged as waste assimilable to the municipal solid ones, in accordance with current regulations.
- After having removed the packaging please assure you about the integrity of the product.

2.2 REMOVING THE STOVE FROM THE PALLET

Proceed as follows:

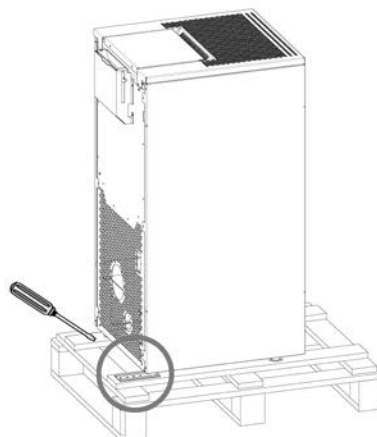

Fig. 1 - Bracket removal

- Remove the brackets which secure the feet of the stove (see **Fig. 1**). Then remove the stove from the pallet.

2.3 STOVE HANDLING

Both whether the stove is packed or not it is necessary to observe the following instructions for handling and transporting the stove from its sale point to its installation point and for any future movements:

- The stove must be handled with idoneous means paying attention to the existing safety regulations;
- do not turn the stove upside down and/or upset it on one side, but keep it in vertical position or as accorded with the constructor instructions;
- if the stove is made up of ceramic, stone, glass or any particularly fragile material components, all must be moved with the utmost care.

3 CHIMNEY FLUE



3.1 INTRODUCTION

This chapter about the Chimney Flue has been drawn up in cooperation with Assocosma (www.assocosma.org) and is based on European Standards (EN 15287 - EN 13384 - EN 1856 - EN 1443) and UNI 10683:2012.

It provides instructions for a good and correct execution of the chimney flue but it does not absolutely replace the current standards which the qualified manufacturer/installer should comply with.

3.2 CHIMNEY FLUE

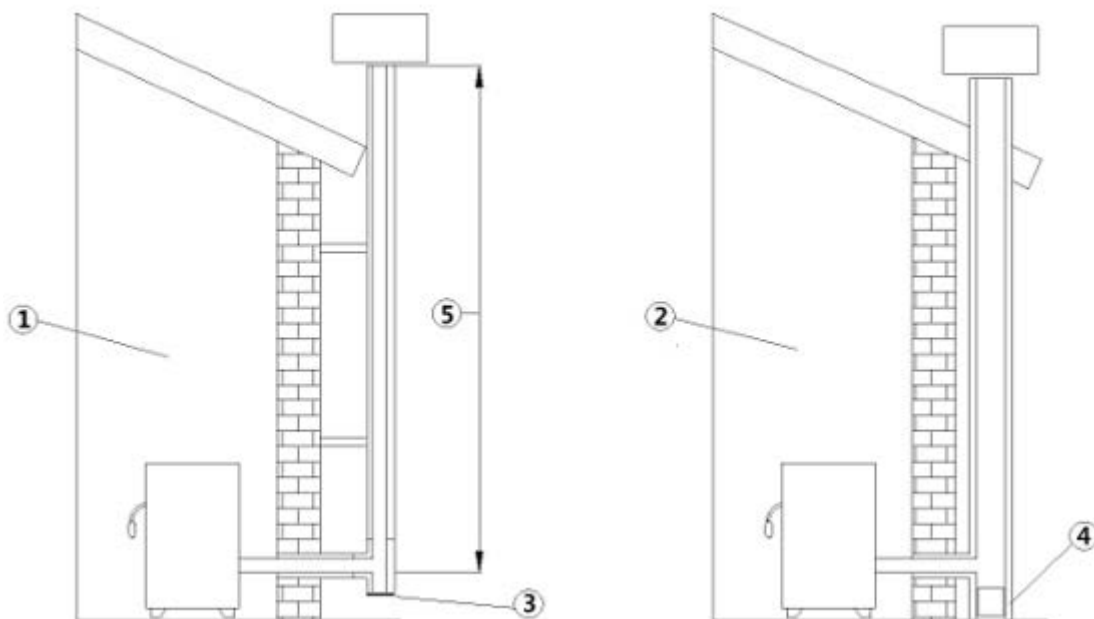

Fig. 2 - Chimney Flues

LEGEND	Fig. 2
1	Chimney flue with insulated stainless-steel pipes
2	Chimney flue on the existing chimney
3	Inspection plug
4	Inspection door
5	≥ 3,5 mt

- The chimney flue or chimney is of great importance for the correct running of the heating appliance.
- It is fundamental that the chimney flue is perfectly built and always maintained with a perfect efficiency.
- The chimney flue must be sole (see **Fig. 2**) with insulated stainless-steel pipes (1) or installed on the existing chimney flue (2).
- Both this solutions must be endowed with an inspection plug (3) and/or an inspection door (4).

3.3 TECHNICAL FEATURES

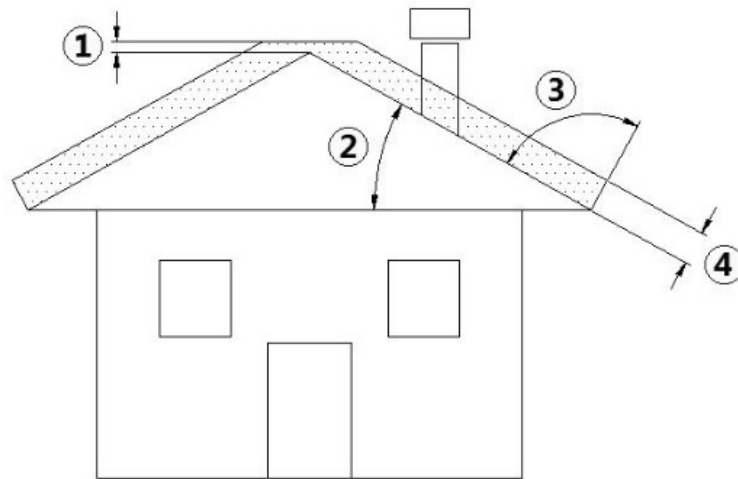

Fig. 3 - Inclined roof

LEGEND	Fig. 3
1	Height over the ridge of the roof = 0,5 mt
2	Roof inclination $\geq 10^\circ$
3	90°
4	Measured distance at 90° from the roof surface = 1,3 mt

- The chimney flue must be sealed from fumes.
- It must have a vertical run without narrowing. It must be realized with fume and condensation resistant materials with thermal insulation and able to last against usual mechanical stresses.



It must be insulated to avoid condensation and to reduce fume cooling effects.

- The stove must be spaced out from fuels or flammable materials with an air gap or with insulating materials. Check the distance with the chimney manufacturer.
- The chimney entrance must be placed in the same room where the appliance is installed or otherwise in the adjacent room and it must be provided with a solid and condensation collection chamber under the entrance, accessible through the sealed metal gate.
- Auxiliary exhaust fans cannot be installed neither along the chimney nor on the chimney pot.
- The inner section of the chimney flue can be round (the best one) or square and the jointed sides must have a minimum radius of 20 mm.
- The section dimension must be:
 - **minimum $\varnothing 100$ mm**
 - **recommended max $\varnothing 180$ mm**
- Made the efficiency of the chimney flue overhauled by an expert stove-repairer and if necessary cover the chimney flue with materials in compliance with current regulations.
- The flue system must be placed on the roof.
- The chimney flue must be provided CE in accordance with EN 1443 regulation. Please find attached an example of label:



Fig. 4 - Example of label

3.4 HEIGHT-DEPRESSION

The depression (draught) of a chimney flue depends also on its height. Check the depression with the values provided at **FEATURES** a pag. 43. Minimum height 3,5 meters.

3.5 MAINTENANCE

- The fumes extraction pipes (fumes conduit + chimney flue + chimney pot) must always be cleaned, scrubbed and checked by an expert stove-repairer, in compliance with current regulations, with the instructions of the stove-manufacturer and the directives of your insurance company.
- In case of doubts, please follow the most restrictive regulations.
- Have your chimney flue and chimney pot checked and cleaned by an expert chimney sweep at least once a week. The chimney sweep has to release a written declaration about the security of the system.
- Not cleaning compromise safety.

3.6 CHIMNEY POT

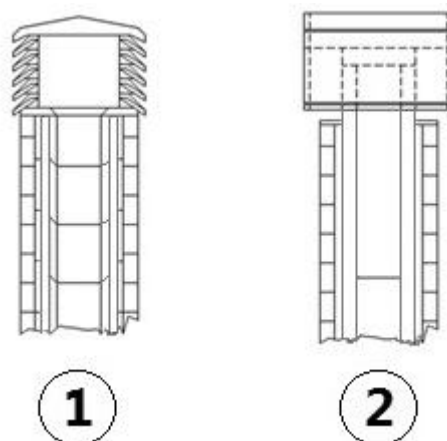

Fig. 5 - Anti-wind chimney pots

The chimney pot is important for the correct running of the heating appliance:

- We recommend using an anti-wind chimney pot, see **Fig. 5**.
- The hole width for fumes exhaust must be the double of the chimney flue width and fitted in a way that the fume exhaust is assured also in case of wind.
- It should prevent the infiltration of rain, snow and animals.
- The outlet height in the atmosphere must be away from the reflux area caused by the roof structure or by obstacles laying nearby (see **Fig. 3**).

3.7 CHIMNEY COMPONENTS

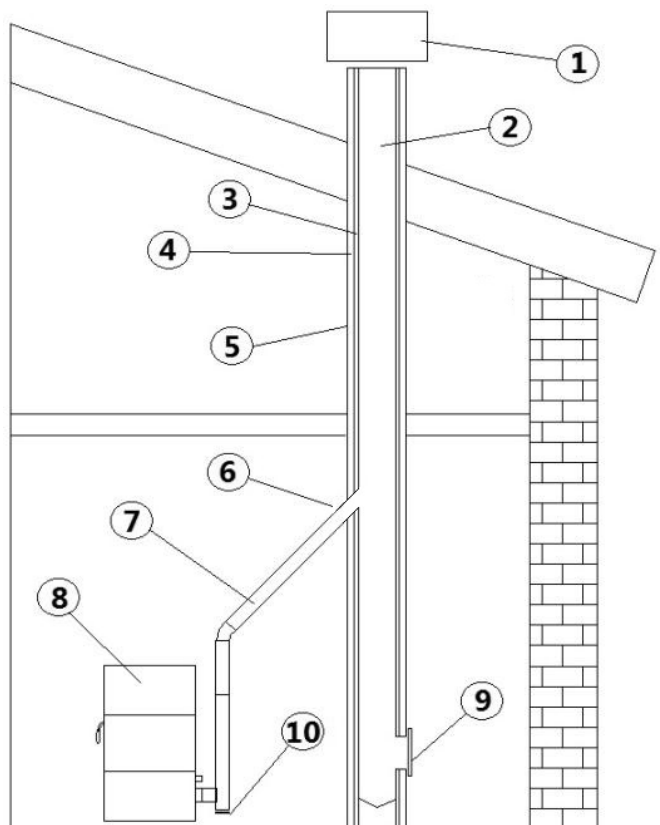

Fig. 6 - Chimney components

LEGEND	Fig. 6
1	Chimney pot
2	Fume outlet
3	Chimney flue
4	Thermal insulation
5	External wall
6	Chimney union
7	Fume pipe
8	Heat generator
9	Inspection door
10	T-union with inspection plug

3.8 CHIMNEY FLUE CONNECTION

Your pellet stove works through a fume draught forced by a fan. It is obligatory to check that all pipes are realized in compliance with the following regulation on material selection: EN 1856-1, EN 1856-2 e UNI/TS 11278. All must be effected by specialized personnel or companies as provided by UNI 10683:2012.

- The connection between the appliance and the chimney flue should be short in order to favor the draught and to avoid condensation in the pipes.
- The fume conduit should be equivalent or longer than the outlet joint ones (Ø 80 mm).
- Some stove models are endowed with a lateral and/or back exhaust. Check that the unused exhaust is sealed with the plug given with standard equipment.

SYSTEM TYPE	Ø80 mm PIPE	Ø100 mm PIPE
Minimum vertical length	1,5 mt	2 mt
Maximum length (with 1 union)	6,5 mt	10 mt

SYSTEM TYPE	Ø80 mm PIPE	Ø100 mm PIPE
Maximum length (with 3 unions)	4,5 mt	8 mt
Maximum number of unions	3	3
Level section (minimum inclination 3%)	2 mt	2 mt
Installation at a height above 1200 m a.s.l.	NO	Obligatory

- Use a plate pipe for stoves of Ø80 mm or Ø100 mm depending on the type of system and with silicone gaskets.
- It is forbidden to use metal, fibre cement or aluminium flexible pipes.
- For change of direction it is obligatory always to use a union (with angle > 90°) with inspection plug which enables an easy periodic cleaning of the pipes.
- Please assure you that after the cleaning the inspection plugs are sealed with its efficient gasket.
- It is forbidden to exhaust flue gases directly from the wall towards the outside and closed spaces also at open top.
- The fume conduit must be placed at a distance of minimum 500 mm from flammable or heat-susceptible components.
- It is prohibited to connect more than one wood/pellet (*) or any other type of appliance (vent cowl...) to the same flue.

(*) unless there are national derogations (for instance in Germany), which under suitable conditions allow for the installation of several appliances in the same fireplace. In any case, strictly follow the product/installation requirements of the relative regulations/legislation in force in that country.

3.9 EXAMPLES OF CORRECT INSTALLATION

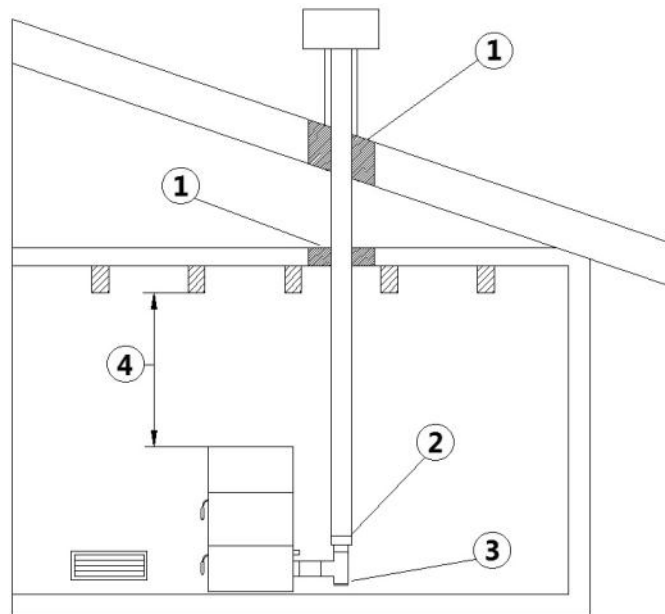

Fig. 7 - Example 1

LEGEND	Fig. 7
1	Insulating material
2	Reduction from Ø100 to Ø80 mm
3	Inspection plug
4	Minimum safety distance = 0,5 mt

- Chimney flue installation Ø100/120 mm with an enlarged drilling for pipe transit.

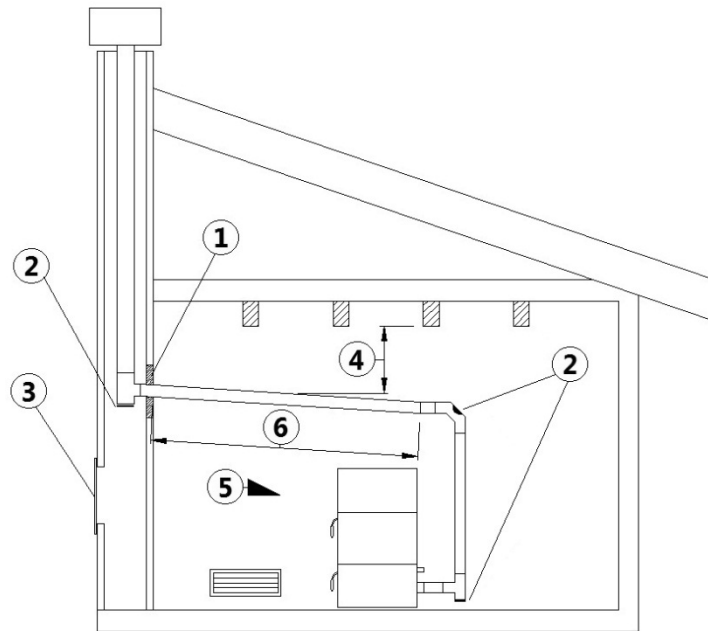

Fig. 8 - Example 2

LEGEND	Fig. 8
1	Insulating material
2	Inspection plug
3	Chimney inspection entrance
4	Minimum safety distance = 0,5 mt
5	Inclination $\geq 3^\circ$
6	Level section ≤ 1 mt

- Old chimney flue with an inserted pipe of minimum $\varnothing 100/120$ mm and with an external door which enables the chimney cleaning.

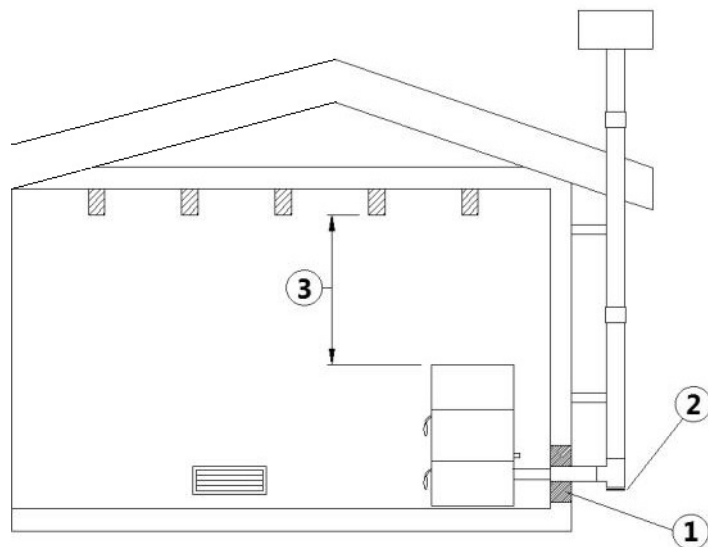

Fig. 9 - Example 3

LEGEND	Fig. 9
1	Insulating material
2	Inspection plug
3	Minimum safety distance = 0,5 mt

- External chimney flue entirely made up of insulated stainless steel pipes, i.e. with double wall of minimum $\varnothing 100/120$ mm: all must be firmly attached to the wall. For chimney against wind effects please (see **Fig. 5**).
- Ducting system through T-unions which enables an easy cleaning without disassembling the pipes.



We recommend to check with your chimney flue manufacturer the safety distances which must be respected and the type of insulating material. The aforesaid regulations are valid also for holes made on the wall (EN 13501 - EN 13063 - EN 1856 - EN 1806 - EN 15827).

4 COMBUSTION AIR

4.1 EXTERNAL AIR INLET

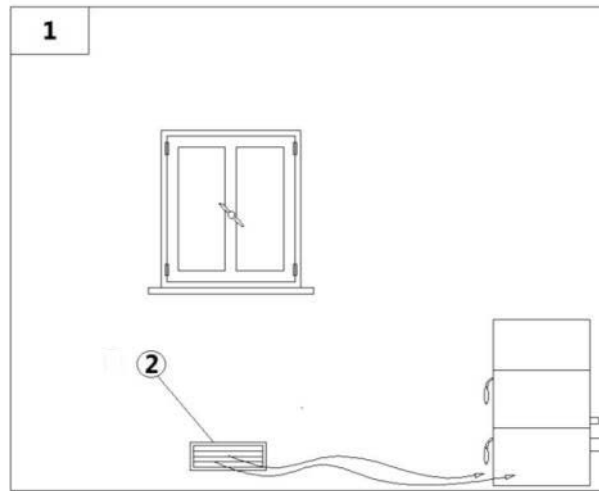

Fig. 10 - Direct air inflow

LEGEND	Fig. 10
1	Room to ventilate
2	External air inlet

- The room must be endowed with an external air recycling for a good climate in your ambient.
- The air inflow from outside to the inner occurs directly, through an opening on the external wall of the room (see **Fig. 10**).
- Bedrooms, garages, and store of flammable materials are excluded.
- The air inlet should have a total net surface of 80 sqcm²: the aforesaid surface is to widen if inside the room there are other activated appliances (for example: electric ventilators for foul air suction, cooker hoods, other stoves, etc...) which depress the environment.
- At switched on appliance it is necessary to check that the pressure fall between the room and the outside does not exceed 4,0 Pa value: if necessary widen the air inlet (EN 13384).
- The air inlet must be realized at a height close to the floor with an external grid against birds. In such a way it cannot be obstructed by any object.
- **In case of installation with sealed-chamber the air inlet is not necessary.**

4.2 COMBUSTIBLE AIR INLET FOR SEALED-CHAMBER INSTALLATION

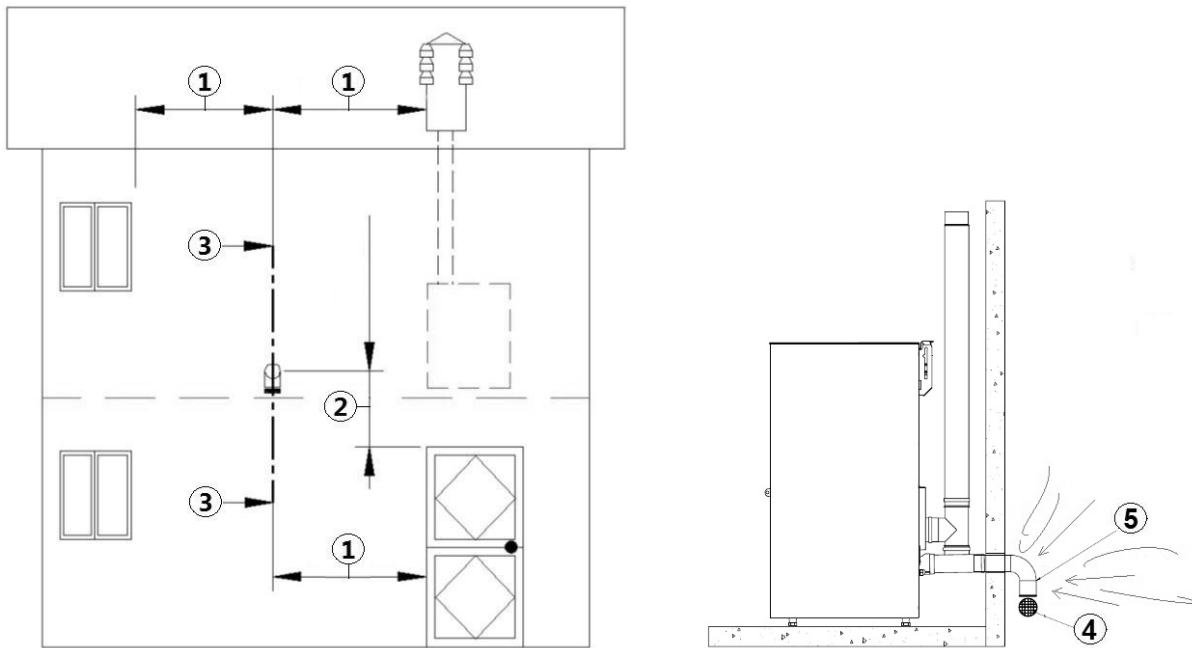

Fig. 11 - Air inlet for sealed-chamber installation

LEGEND	Fig. 11
1	$\geq 1,5$ mt
2	$\geq 0,3$ mt
3-3	Sectional view
4	Shield grid
5	Curve inlet to turn downwards

Check if the purchased stove has a sealed-chamber. If the stove is endowed with a sealed-chamber and you want also the whole installation with sealed chamber, please read the following instructions:

- It is necessary to extract the air for combustion directly from outside.
- Use a tube with minimum $\varnothing 60$ mm and maximum 2 meters length; to connect see the back of the stove.
- French standards require installation in double-walled flues (concentric system). The combustion air is drawn from the cavity.
- During installation step is necessary to verify the minimum distances required for the combustibles air inlet as (for example) an open door or window causes a vortex which could remove the combustibles air necessary to the stove (see the underlying scheme).
- On the external wall it is necessary to install a curve at 90° to protect the combustibles air inflow from wind effects: turn the curve inlet downwards, see **Fig. 11**.
- Endow the curve with an external shield grid against birds in such a way that it cannot be obstructed by any object.



Check with your local authorities if exists any restrictive regulation regarding the combustibles air inlet: if present, they must be applied



In some countries and/or regions the installation with sealed-chamber is obligatory: in case of doubt, please follow the most restrictive regulations.

4.3 COMBUSTIBLE AIR INLET FOR SEALED-CHAMBER INSTALLATION

How to connect to the stove in the sealed chamber with concentric system:



Fig. 12 - Phase 1

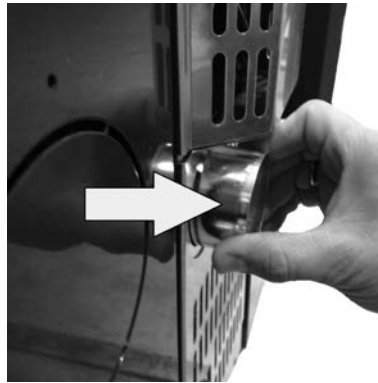

Fig. 13 - Phase 2

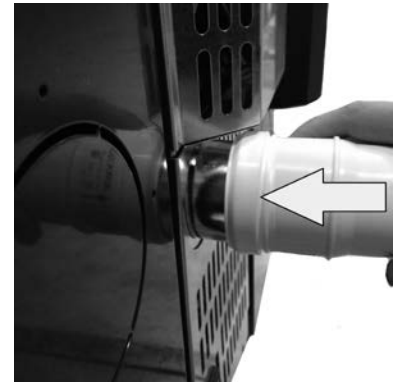

Fig. 14 - Phase 3

- Original position with completely embedded tube (see **Fig. 12**).
- Pull out the tube for 2 cm (see **Fig. 13**).
- Insert the female tube \varnothing 6 cm (see **Fig. 14**).

5 INSTALLATION

5.1 INTRODUCTION

- The assembly position must be chosen depending on environment, outlet, chimney flue.
- Check with local authorities if there are any restrictive regulations which regard the combustible air inlet, room ventilation, fume exhaust system together with chimney flue and chimney pot.
- Check if there is the combustible air inlet.
- Check the probable presence of other stoves or appliances which could depress the room.
- Check at switched on stove if there is the presence of CO in the room.
- Check if the chimney has the necessary draught.
- Check if during the fume passage all has been executed in safety (probable fume losses and distances from flammable materials, etc...).
- The installation of the appliance must enable an easy access for appliance, fume exhaust pipes and chimney flue cleaning.
- The installation must enable an easy access to the electric connection plug (see **ELECTRIC CONNECTION a pag. 26**).
- To install more appliances, the external air inlet must be correctly dimensioned (see **FEATURES a pag. 43**).

5.2 OVERALL DIMENSIONS

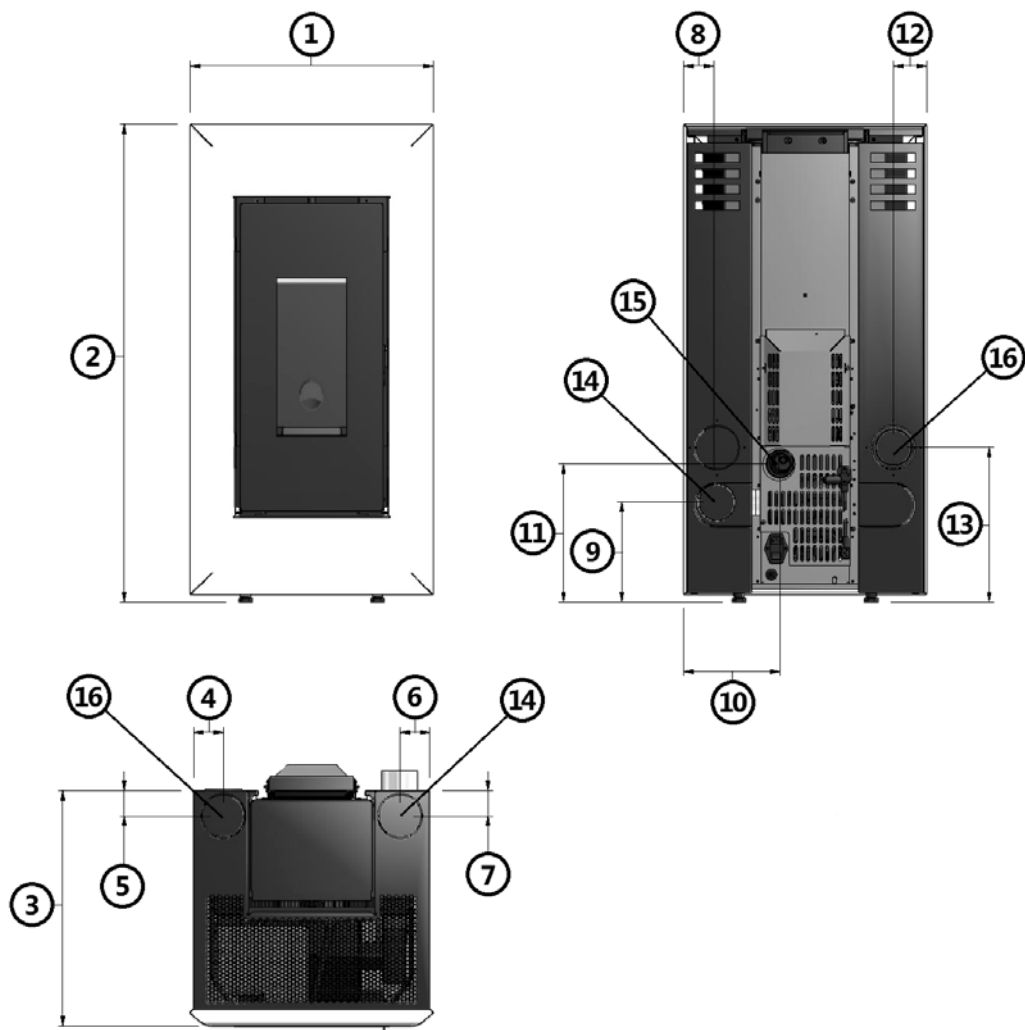

Fig. 15 - General dimensions: Vega At / Trend At

LEGEND	Fig. 15
1	54 cm
2	105 cm
3	54 cm
4	7,5 cm
5	8 cm
6	7,5 cm
7	8 cm
8	7,5 cm
9	22 cm
10	22 cm
11	32 cm
12	7,5 cm
13	34 cm
14	Exhaust fumes d.8 cm
15	Hole combustion air inlet d.6 cm
16	Ducting outlet d.8 cm

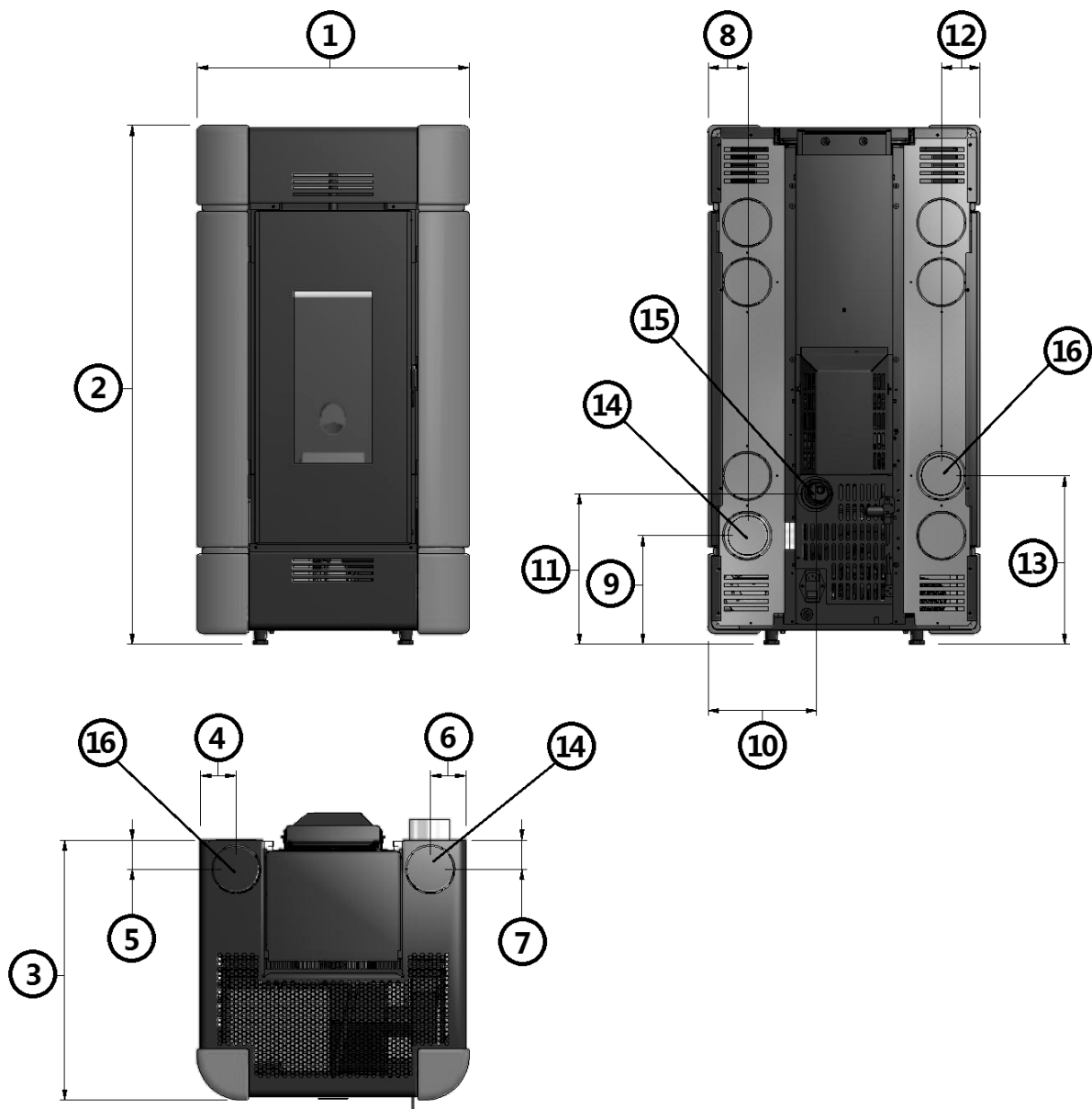

Fig. 16 - General dimensions: Sire³ Plus 11KW

LEGEND	Fig. 16
1	54,4 cm
2	104,8 cm
3	52,3 cm
4	7,1 cm
5	5,8 cm
6	7,1 cm
7	5,8 cm
8	7,7 cm
9	21,7 cm
10	21,6 cm
11	30,3 cm
12	7,7 cm
13	34 cm
14	Exhaust fumes d.8 cm
15	Hole combustion air inlet d.6 cm
16	Ducting outlet d.8 cm

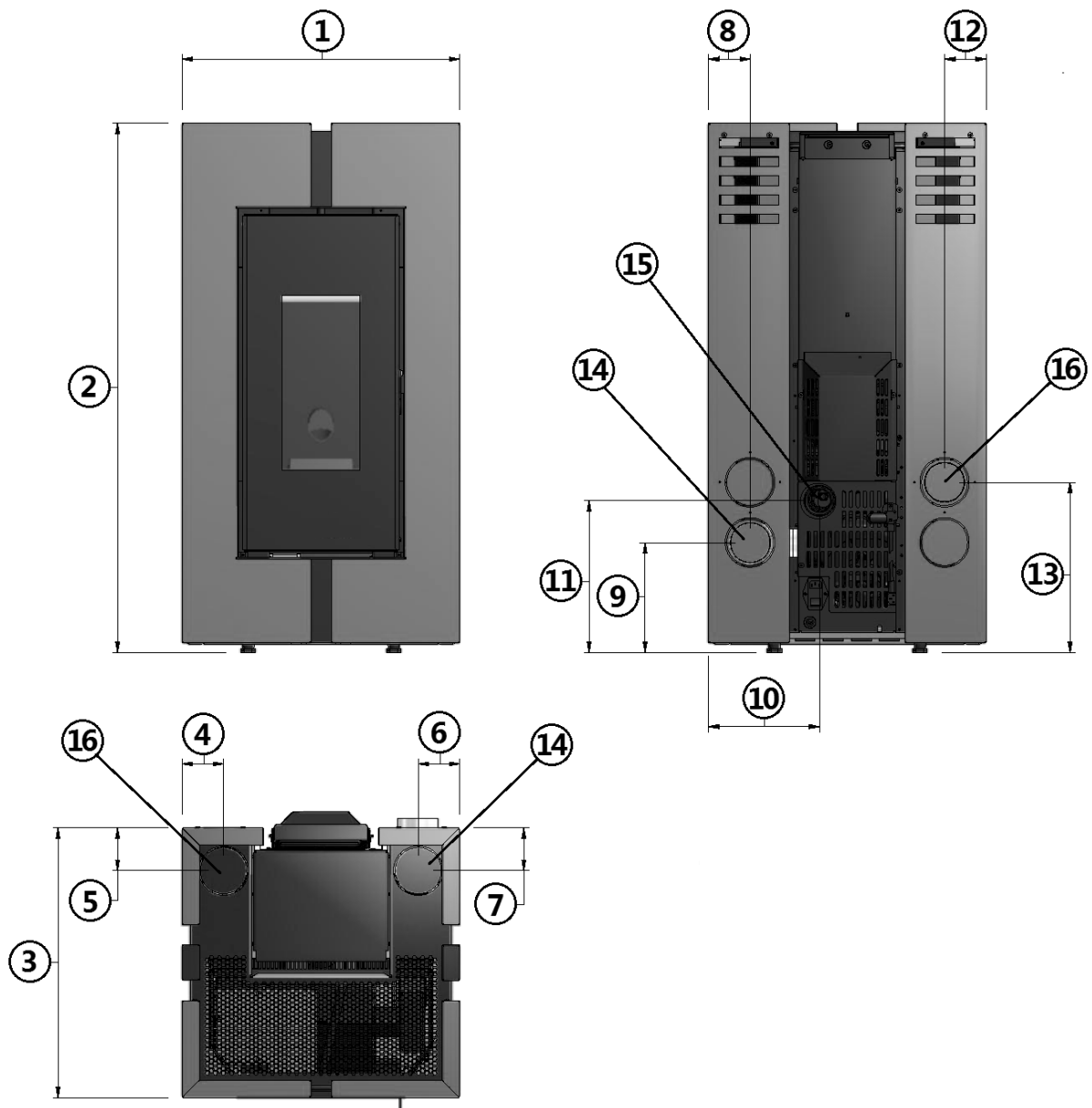

Fig. 17 - General dimensions: Doge³ Plus 11KW

LEGEND	Fig. 17
1	55,4 cm
2	105,6 cm
3	54 cm
4	8,3 cm
5	8,5 cm
6	8,3 cm
7	8,5 cm
8	8,3 cm
9	21,7 cm
10	22,2 cm
11	30,3 cm
12	8,3 cm
13	34 cm
14	Exhaust fumes d.8 cm
15	Hole combustion air inlet d.6 cm
16	Ducting outlet d.8 cm

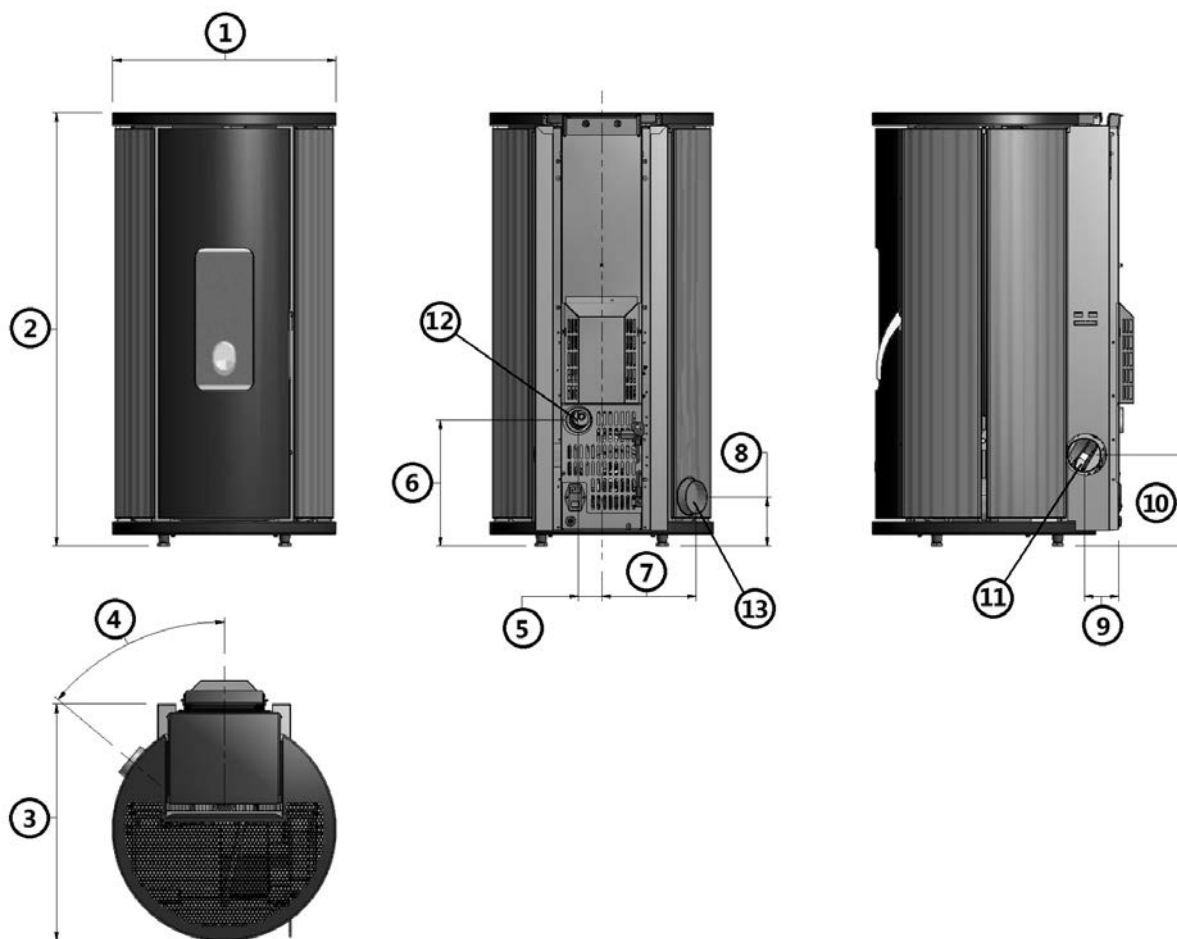

Fig. 18 - General dimensions: Sfera³11KW / Sfera³ Plus 11KW / Globe At

LEGEND	Fig. 18
1	53,6 cm
2	104 cm
3	57 cm
4	45°
5	5,5 cm
6	30,3 cm
7	22,7 cm
8	11,7 cm
9	5,5 cm
10	21,7 cm
11	Exhaust fumes d.8 cm
12	Hole combustion air inlet d.6 cm
13	Ducting outlet d.8 cm (Sfera ³ Plus model)

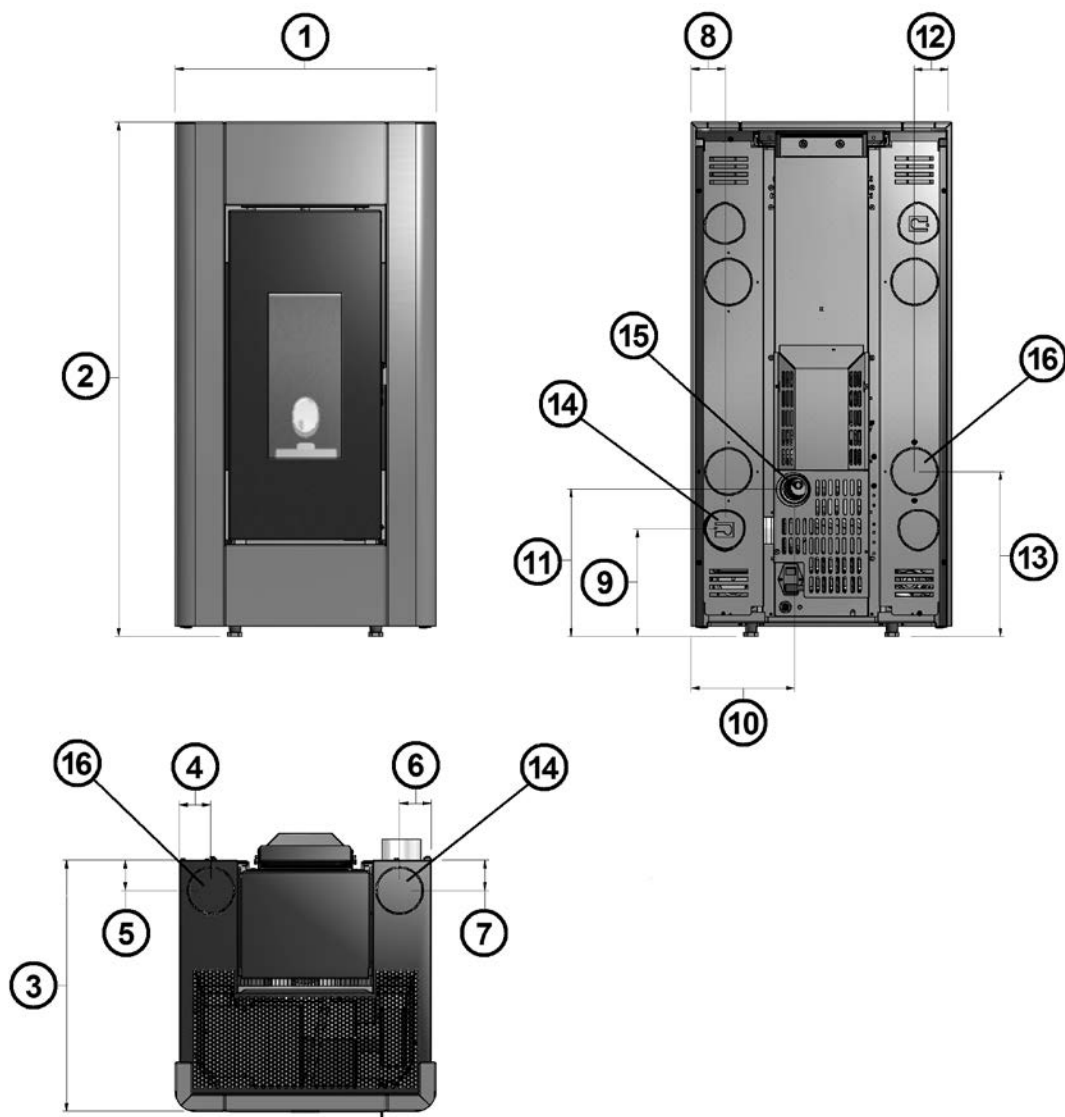

Fig. 19 - General dimensions: Prince³ 11KW/Prince³ Plus 11KW

LEGEND	Fig. 19
1	54 cm
2	105 cm
3	54 cm
4	7,5 cm
5	8 cm
6	7,5 cm
7	8 cm
8	7,5 cm
9	22 cm
10	22 cm
11	32 cm
12	7,5 cm
13	34 cm
14	Exhaust fumes d.8 cm
15	Hole combustion air inlet d.6 cm
16	Ducting outlet d.8 cm (Prince ³ Plus model)

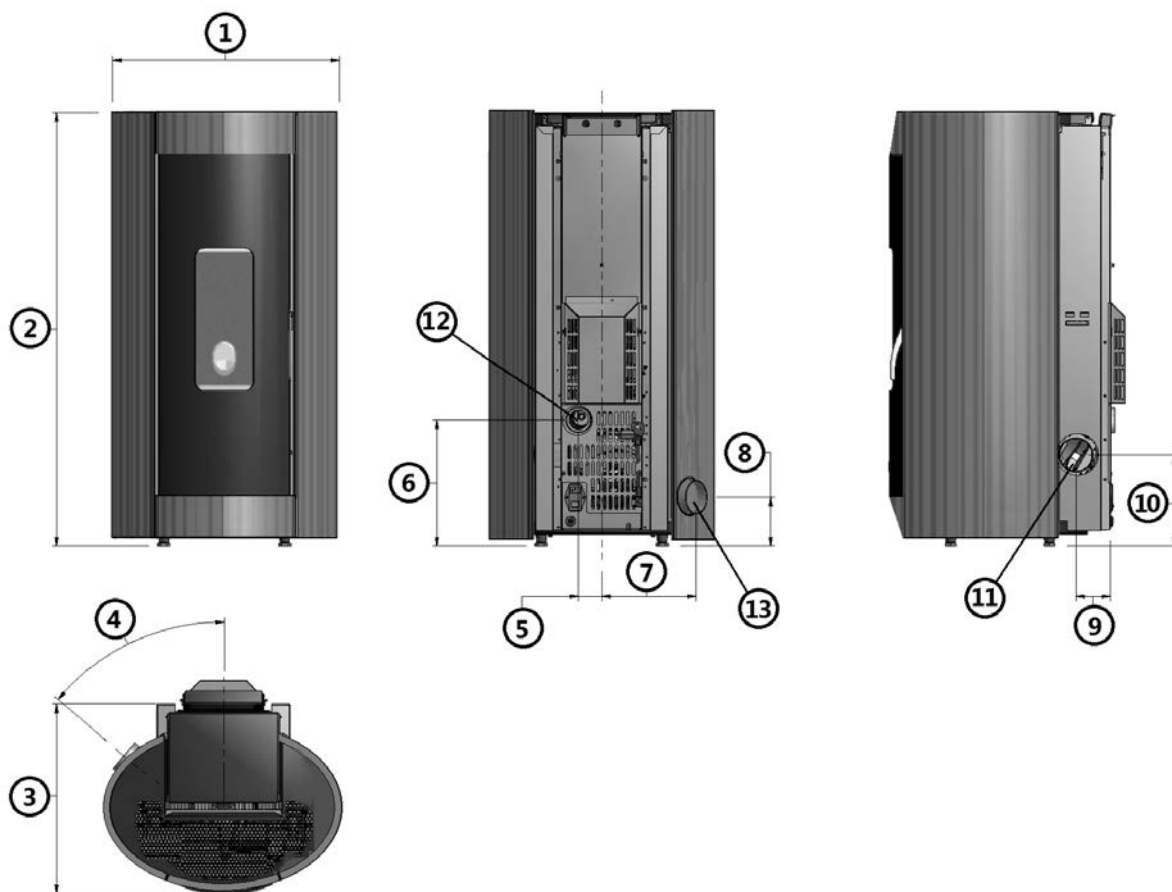

Fig. 20 - General dimensions: Elise³ Plus 11KW

LEGEND	Fig. 20
1	65 cm
2	108 cm
3	60,3 cm
4	45°
5	5,5 cm
6	30,3 cm
7	22,7 cm
8	11,7 cm
9	8,2 cm
10	22 cm
11	Exhaust fumes d.8 cm
12	Hole combustion air inlet d.6 cm
13	Ducting outlet d.8 cm

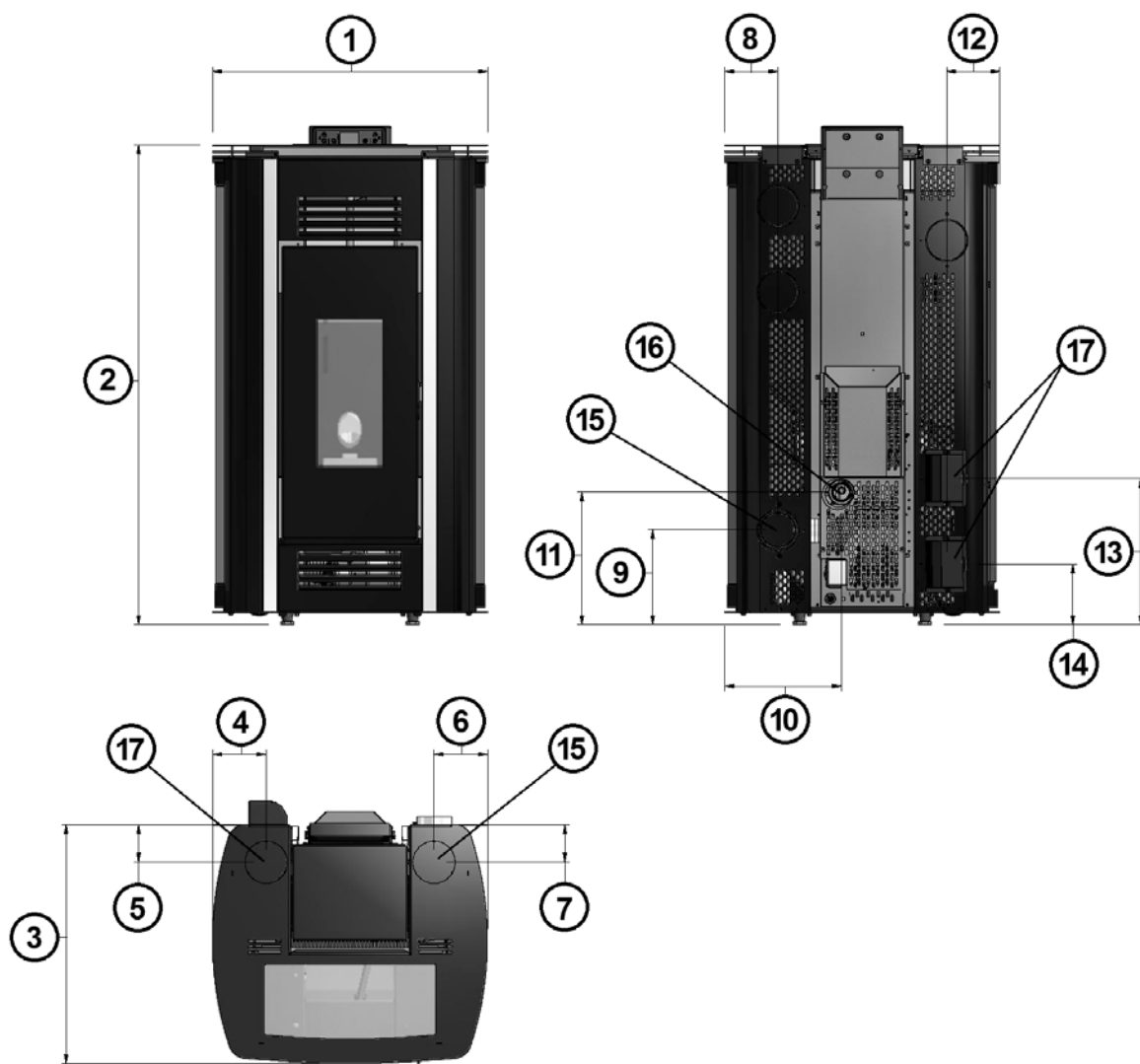

Fig. 21 - General dimensions: Venus³ Plus 12,5KW

LEGEND	Fig. 21
1	63,6 cm
2	111,2 cm
3	55,4 cm
4	12,4 cm
5	8,7 cm
6	12,4 cm
7	8,7 cm
8	12,6 cm
9	21,9 cm
10	26,9 cm
11	30,2 cm
12	12,6 cm
13	40 cm
14	14 cm
15	Exhaust fumes d.8 cm
16	Hole combustion air inlet d.6 cm
17	Ducting outlet d.8 cm

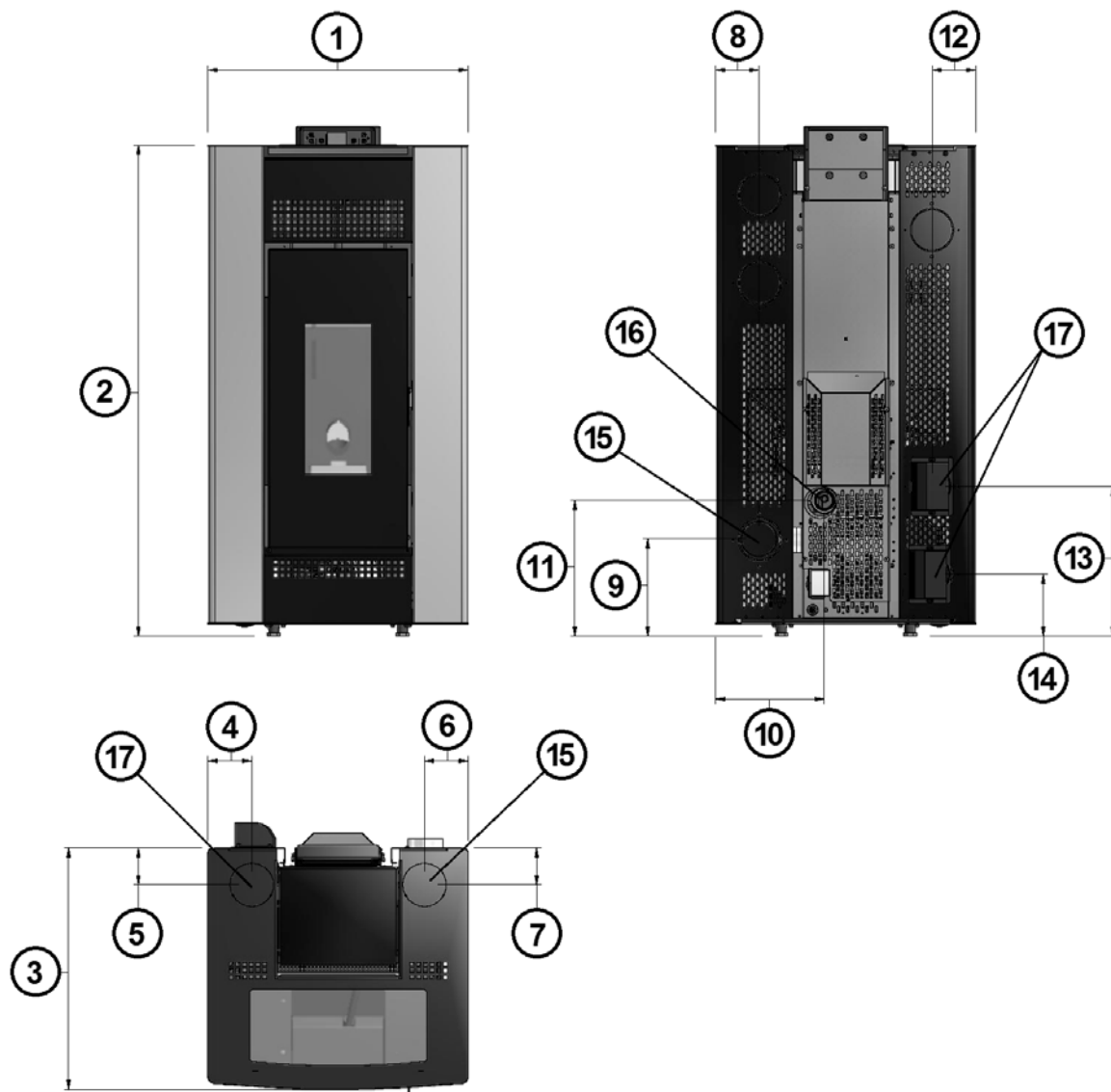

Fig. 22 - General dimensions: Joy At

LEGEND	Fig. 22
1	58,5 cm
2	111,2 cm
3	55 cm
4	9,8 cm
5	8,7 cm
6	9,8 cm
7	8,7 cm
8	9,7 cm
9	22 cm
10	24,4 cm
11	30,2 cm
12	9,7 cm
13	40 cm
14	14 cm
15	Exhaust fumes d.8 cm
16	Hole combustion air inlet d.6 cm
17	Ducting outlet d.8 cm

5.3 GENERAL INSTALLATION

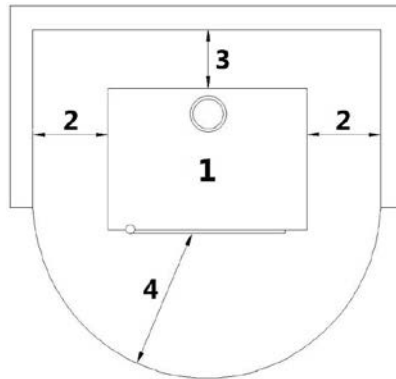

Fig. 23 - General installation

LEGEND	Fig. 23
1	Stove
2	Minimum lateral distance = 300 mm
3	Minimum rear distance = 200 mm
4	Minimum front distance = 1000 mm

It is obligatory to install the stove away from walls and/or pieces of furniture, with a minimum air flow of 300 mm on the sides and 200 mm on the back, to enable an efficient appliance cooling and a good distribution of heat in the room (see Fig. 23).

If the walls are made up of flammable materials, check the safety distances (see Fig. 23).

At maximum power check that the wall temperature does not ever exceed 80°C. If it would be necessary please install a fire resistant plate on the concerned walls.

In some countries also masonry load-bearing walls are considered flammable.

5.4 FRONTAL PANEL ASSEMBLY (VEGA / TREND / PRINCE³ / PRINCE³ PLUS MODELS)

For frontal panel installation, proceed as follows:



Fig. 24 - Frontal panel assembly



Fig. 25 - Frontal panel position



Fig. 26 - Frontal panel fixing

- Hook the frontal panel cogs at its specific holes (see Fig. 24).
- Place the frontal panel in the correct position (see Fig. 25).
- Fix the frontal panel by tightening two screws in the lower part (see Fig. 26).

5.5 FRONTAL PANEL ASSEMBLY (VEGA STONE MODEL)

For frontal panel installation, proceed as follows:

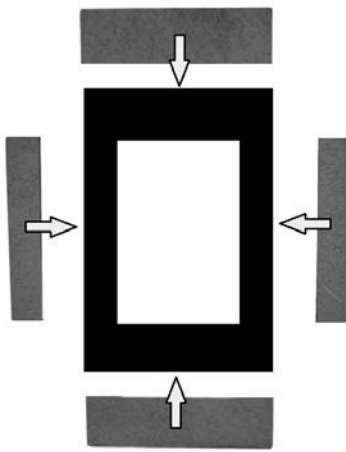

Fig. 27 - Place the stones



Fig. 28 - Fasten the stones

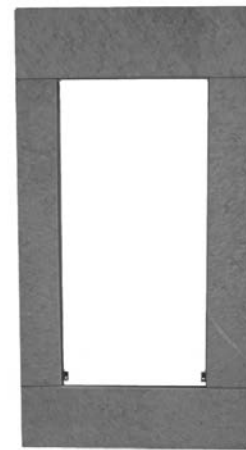

Fig. 29 - Assembled frame

- Place the stones on the frame (see **Fig. 27**).
- Fasten the stones with the screws behind the frame (see **Fig. 28**).
- Assembled frame (see **Fig. 29**).



Fig. 30 - Frontal panel assembly



Fig. 31 - Frontal panel position



Fig. 32 - Frontal panel fixing

- Hook the frontal panel cogs at its specific holes (see **Fig. 30**).
- Place the frontal panel in the correct position (see **Fig. 31**).
- Fix the frontal panel by tightening two screws in the lower part (see **Fig. 32**).

5.6 TILE ASSEMBLY (SIRE³ PLUS MODEL)

Proceed as follows to assemble the tiles:



Fig. 33 - Profile and tiles



Fig. 34 - Tighten the profile to the tiles



Fig. 35 - Fixing to stove

- Assemble the galvanised profile to the tiles (see **Fig. 33** and **Fig. 34**).
- Connect the tile teeth to the stove (see **Fig. 35**).

5.7 PANELS ASSEMBLY (SFERA³ / SFERA³ PLUS MODELS)

For panels installation, proceed as follows:

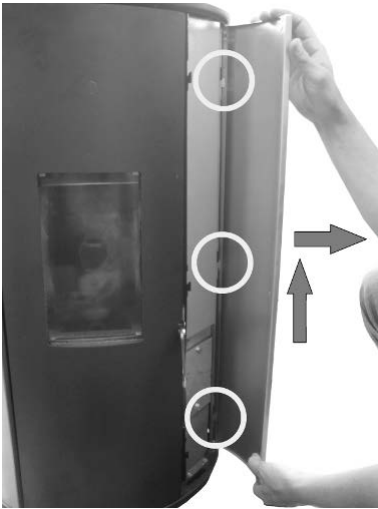

Fig. 36 - Panels assembly



Fig. 37 - Panel with hole assembly (Sfera³ Plus model)



Fig. 38 - Open the hole (Sfera³ Plus model)

- Hook the panels at its specific cogs (see **Fig. 36**).
- Hook the punched panel at its specific cogs at the back of stove (see **Fig. 37**).
- For Sfera³ Plus model with lateral duction, open the hole as shown in **Fig. 38**.



Fig. 39 - Place the bracket



Fig. 40 - Screw the bracket

- Place the bracket between the colored panels, in the upper part, to lock the sides (see **Fig. 39**).
- Blocking the bracket with the screw (see **Fig. 40**).

5.8 PANELS ASSEMBLY (VENUS³ PLUS MODEL)

For panels installation, proceed as follows:



Fig. 41 - Upper screws removal



Fig. 42 - Backward screws removal



- Remove the top cover: unscrew the upper screws, backward screws and front screws (see **Fig. 41**, **Fig. 42** and).

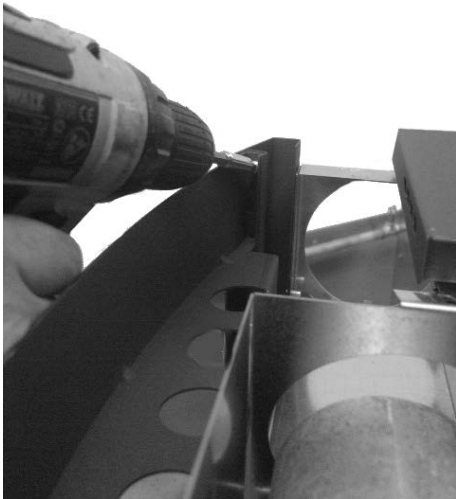

Fig. 43 - Upper curved profiles removal



Fig. 44 - Supports to bend

- Remove the 2 upper curved profiles (see **Fig. 43**).
- Slightly bend the supports in order for them to compensate any movement in the metal or majolica panels (see **Fig. 44**).



Fig. 45 - Side panel insertion



Fig. 46 - Replace upper curved profiles

- Insert from on high the metal or majolica side panels on the appropriate guides getting it slightly course all the way (see **Fig.45**).
- Screw the upper profiles (see **Fig. 46**) and replace the top cover.

5.9 FRONT PANEL ADJUSTMENTS (ELISE³ PLUS MODEL)

You can adjust the top and bottom panels to bring them flush with the side panels
Proceed as follows:

TOP PANEL



Fig. 47 - Adjustment 1



Fig. 48 - Adjustment 2

- Loosen the bottom screw (see **Fig. 47**) and the top screw with a screwdriver (see **Fig. 48**).

BOTTOM PANEL



Fig. 49 - Adjustment 1



Fig. 50 - Adjustment 2

- Loosen the screw below the base with CH 7 key (see **Fig. 49**) and the screw above with a screwdriver (see **Fig. 50**).

5.10 STOVE DOOR REMOVAL/INSTALLATION

DOOR REMOVAL

For some operations (e.g.: side panel assembly and cleaning) you must remove the stove door.
To remove the door:

- Open the door.
- Use a screwdriver to rotate the lever in the direction of the arrow (vedi **Fig. 51**).
- Lift the door to allow the door pivots to slide out of the structure bracket (see **Fig. 52**).
- Keep the door in a safe place until next use.

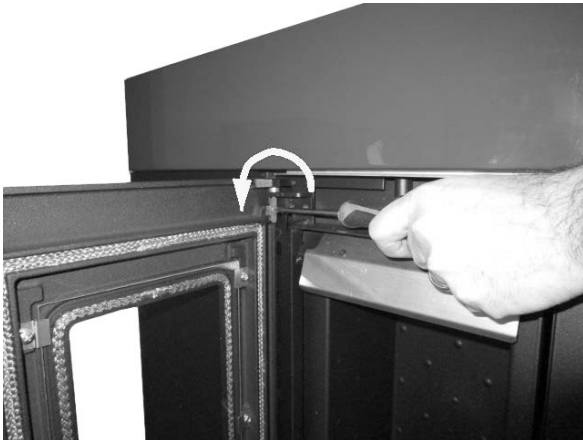

Fig. 51 - Remove screws



Fig. 52 - Door removal

DOOR ASSEMBLY

To assemble the door you must centre the pivots fixed to the door, on the structure bracket. After having mounted the door with the screwdriver, lift the lever so that the door is locked.

5.11 CONNECTION TO THE EXTERNAL THERMOSTAT

The stove works through a thermostat probe placed in its inner. If you desire, the stove can be connected to an external room thermostat. This operation must be executed by an authorized technician.

Connect the wires from the external thermostat to the "Term opt" terminal on the stove board. Activate the external thermostat (default setting OFF) as indicated below:

- Press the "menu" button.
- Scroll with the arrows to "Settings".
- Select by pressing "menu".
- Scroll with the arrows again to "Ext.Thermostat".
- Select by pressing "menu".
- Press the - + buttons.
- To activate the external thermostat select "on".
- Press the "menu" button to confirm.

5.12 ELECTRIC CONNECTION



Warning: the appliance must be installed by an authorized technician!

- The electric connection occurs through a cable with plug put in an electric socket which is able to support charge and tension specific of every model, as described in the technical datas table (see **FEATURES a pag. 43**).
- The plug must be easily accessible when the appliance is installed.
- Please further assure you that your network is endowed with an efficient earth connection: if it does not exist or if it is not efficient, please endow you with one in compliance with the law.
- Connect the supply cable first on the back of the stove (see **Fig. 53**) and then at a wall electric socket.



Fig. 53 - Electric socket with master switch

- The master switch O/I (see **Fig. 53**) is to open only to switch the stove on, otherwise it is advisable to keep it off.
- Do not use extension cables.
- If the feeder cable is damaged, it must be replaced by an authorized technician.
- When the stove is not going to be used for a long period of time, it is advisable to remove the plug from the socket on the wall.

5.13 STOVE CALIBRATION AND DEPRESSION MEASUREMENT

This stove has a pickup point positioned on the tank in order to measure the depression of the combustion chamber and verify its proper operation.

To do this, proceed as follows:

- Unscrew nut "D" on the rear of the stove and connect a digital pressure switch with a tube to detect the negative pressure (see **Fig. 54**).
- Load the feed screw via appropriate function.
- Start the stove and set "Set_Flame" to power 1 (the start-up time of this stove lasts between 8 and 10 minutes to ensure minimum draught).
- Compare the read values with those on the table.
- Change power every 10 minutes and wait for it to stabilise.
- Access the user menu and, if necessary, change the parameters.



Fig. 54 - Digital pressure switch connection

DATA	P1	P2	P3	P4	P5
Stove depression - temperature 11 kW	21 Pa - 106°C	35 Pa - 108°C	46 Pa - 128°C	58 Pa - 150°C	72 Pa - 180°C
Stove depression - temperature 12,5 kW	21 Pa - 106°C	35 Pa - 108°C	46 Pa - 128°C	70 Pa - 181°C	75 Pa - 181°C

NB: for good combustion, the depression values must be between + -5 Pa and the temperature values between + - 10°C.

5.14 HOT AIR DUCTING SYSTEM (VEGA / TREND / SIRE³ PLUS / DOGE³ PLUS / SFERA³ PLUS / ELISE³ PLUS / PRINCE³ PLUS MODELS)

The stove is fitted with 1 hot air outlet.



Fig. 55 - Upper pipe position



Fig. 56 - Upper hot air outlet



Fig. 57 - Back pipe position



Fig. 58 - Back hot air outlet

- The hot air can be forced in ducts in the upper part (see **Fig. 55** and **Fig. 56**).
- Or make the air exit from the rear (see **Fig. 57** and **Fig. 58**).



Fig. 59 - Ducting system example

- If the stove is not fitted with ducting system, it provide a hot air capacity ranging from a minimum of 61 m³/h to a maximum of 130 m³/h with a temperature ranging between 90°C and 136°C.
- For the ducting system, we recommend using a pipe with a maximum length of 6 mt and up to three 90° elbows in order to maintain hot air temperature.
- Use pipes with smooth internal surface and a diameter of 80 mm.
- Fit the pipe with insulating material if it passes through a cold wall.
- The outlet must be protected by a grid with wide mesh and a minimum total surface area of 40 cm².
- If the pipes used are longer than 6 mt, the air capacity ranges from a minimum of 58 m³/h to a maximum of 883 m³/h and the temperature from 65°C to 99°C. (These values refer to the laboratory used for the tests. The room where the stove is installed may register different values both in terms of capacity and temperature).
- If you wish to increase air capacity, install at the end of the pipe a small wall-mounted fan with a capacity exceeding 130 m³/h. The installation must be carried out by an authorised technician.
- According to the factory parameters, 1/2 of the generated heat is conveyed into the room where the stove is installed, while the remaining 1/2 are conveyed through the left ducting pipe system.
- See the dedicated chapter of the USER MANUAL for the various adjustments.

5.15 HOT AIR DUCTING SYSTEM (VENUS³ PLUS / JOY AIRTIGHT)

The stove is fitted with 1 upper and 1 rear hot air outlets.

SOLUTION A: ducting with the upper and rear hot air outlet (see and **Fig. 61**).



Fig. 60 - Upper hot air outlet



Fig. 61 - Rear hot air outlet



Fig. 62 - Pipe positioning for ducting



Fig. 63 - Pipe fastening

- Position the pipes as shown in **Fig. 62**.
- Fasten the pipe for the upper hot air outlet (see **Fig. 63**).

SOLUTION B: ducting with the rear hot air outlet (see **Fig. 64**).



Fig. 64 - Rear hot air outlet



Fig. 65 - Pipe positioning for ducting



Fig. 66 - Pipe fastening

- Position the pipes as shown in **Fig. 65**.
- Fasten the pipes for the rear hot air outlet (see **Fig. 66**).



Fig. 67 - Ducting system example

- A stove with no ducting has a variable air flow rate from a minimum of 59 m³/h to a maximum of 153 m³/h, and an air temperature which varies from a minimum of 90°C to a maximum of 150°C; these data are valid for each of the 2 outputs and the fan of the central environment.
- In the case of ducting, it is recommended not to exceed 8 metres of pipe and 3 x 90° bends, otherwise the hot air loses its effectiveness.
- Use pipes with an 80 mm diameter with smooth internal walls.
- If the pipes pass through cold walls, insulate the pipe with insulating material.
- Place a protective grille with large mesh and a total minimum net surface area of 24 cm² over the outlet.
- There can be a variable air flow rate from a minimum of 35 m³/h to a maximum of 80 m³/h and an air temperature which varies from a minimum of 40°C to a maximum of 100°C after the 8 metres of pipe. (These values were recorded in the testing laboratory; there may be differences in flow and temperature in the installation room).
- If you wish to increase the air flow, install a small wall-mounted fan on the outlet with a flow rate of more than 80 m³/h; this should be performed by an authorised technician.
- With the factory parameters, 26% of the heat produced by the stove is conveyed into the room where it is installed and the remaining 37% comes out from the ducting on the right and 37% from the left one.
- To get the best performance you need to balance the power with the air flow. This operation must be performed with the assistance of an authorised technician.
- The ductable fans cannot be deactivated, but they can be operated at a power value between 1 and 5 or in automatic mode.

5.16 USING THE STOVE WITHOUT DUCTING

The stove can be used without ducting the air to other environments.

In this case, assemble the environment diffuser in the stove's rear (see **Fig. 68**).



Fig. 68 - Diffuser assembly

6 SPECIAL MAINTENANCE

6.1 INTRODUCTION

For a long working life of the stove, have a periodic cleaning of the stove as described in the following paragraphs.

- Fume outlet pipes (fume conduit + chimney flue + chimney pot) must always be cleaned, scrubbed and checked by an authorized technician in compliance with local regulations, with the instructions of the manufacturer and those of your insurance company.
- It is also necessary to have the combustion chamber, motors and fans cleaned and to have the gaskets and the electrical elements checked at least once a year.



All these operations must be planned in time with your Authorized Technical Assistance Service.

- After a long ineffective time, before turning on the stove check if there are obstructions in the fume exhaust.
- If the stove had been using continuously and intensely, the whole system (chimney included), must be cleaned and checked more frequently.
- In case of replacement of damaged pieces please ask for the original spare part at the Authorized Retailer.

6.2 FEED SCREW MAINTENANCE

Proceed as follows for the feed screw maintenance:



Fig. 69 - Screw removal

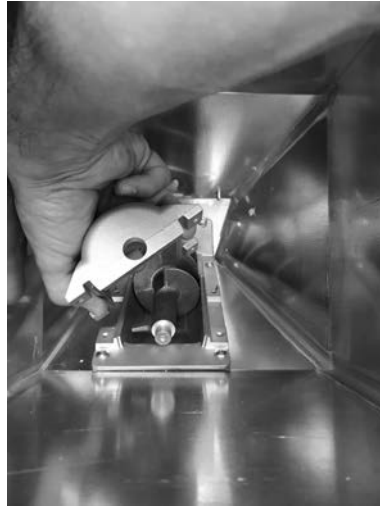

Fig. 70 - Coque removal



Fig. 71 - Gear motor removal

- Enter the tank and loosen the 4 screws of the feed screw coque (see **Fig. 69**).
- Remove the coque (see **Fig. 70**).
- Remove the gear motor by loosening the locking screw (see **Fig. 71**).



Fig. 72 - Spiral removal



Fig. 73 - Bearing removal

- Remove the spiral (see **Fig. 72**).
- If worn, remove the bearing (see **Fig. 73**) and replace it.
- To reassemble, proceed in reverse order.

6.3 FUME CHAMBER AND FUME PASSAGES CLEANING

Every season (or every 1500 operation hours) the fume chamber and the fume passages cleaning must be executed.

- Remove the sides of the stove according to the model:

VEGA / SIRE³ PLUS / PRINCE³ / TREND / PRINCE³ PLUS: remove the side upper screws (see **Fig. 74** and **Fig. 75**), then remove the side completely (see **Fig. 76**).



Fig. 74 - Removing the upper screw



Fig. 75 - Removing the rear screw



Fig. 76 - Removing the side

DOGE³ PLUS: remove the lower screws from the central panel (see **Fig. 77**) and then remove the panel (see **Fig. 78**).



Fig. 77 - Removing the lower screws



Fig. 78 - Removing the central panel

SFERA³ / SFERA³ PLUS: unhook the side panels (see **Fig. 79**).



Fig. 79 - Sfera³ / Sfera³ Plus: unhook the side panels.

GLOBE: Remove the 6 screws from the upper cover (see **Fig. 80** and **Fig. 81**), and then remove the later (see **Fig. 82**). Unhook the lateral sides (see **Fig. 83**).



Fig. 80 - Cover 1 screw removal



Fig. 81 - Cover 2 screw removal



Fig. 82 - Remove the cover



Fig. 83 - Unhook the side

ELISE³ PLUS: loosen the door-stop screw and remove the door (see **Fig. 84** and **Fig. 85**). Loosen the 2 screws inside the side panel (see **Fig. 86** and **Fig. 87**) and then unhook the side panel (see **Fig. 88**).



Fig. 84 - Loosen the screw



Fig. 85 - Door removal



Fig. 86 - Loosen the top screw



Fig. 87 - Loosen the bottom screw



Fig. 88 - Remove side panels

VENUS3PLUS: remove the screws from the upper cover and then remove the latter (see **Fig.89**). Remove the 2 upper curve profiles (see **Fig.90**) and the sides (see **Fig.91**).



Fig. 89 - Remove the cover



Fig. 90 - Removing the upper curve profiles



Fig. 91 - Remove side panels

JOY AIRTIGHT: remove the side screws (see **Fig. 92** and **Fig. 93**), then remove the side completely (see **Fig. 94**).



Fig. 92 - Remove the side screws



Fig. 93 - Rear screws removal



Fig. 94 - Remove side panels

- Clean the 2 pipes inside the combustion chamber (placed on the top) with a pipe cleaner (see **Fig. 95**, **Fig. 96** and **Fig. 97**).
- Loosen the two screws from the galvanised panel closing the flue gas compartment, which is found on both sides of the stove (see **Fig. 98**).
- Clean with a pipe cleaner and suction any ash accumulated inside (see **Fig. 99** and **Fig. 100**).
- After the cleaning the opposite operation is to repeat checking the gasket efficiency and integrity: if necessary provide for its replacement by an Authorized Technician.



Fig. 95 - Fume passages

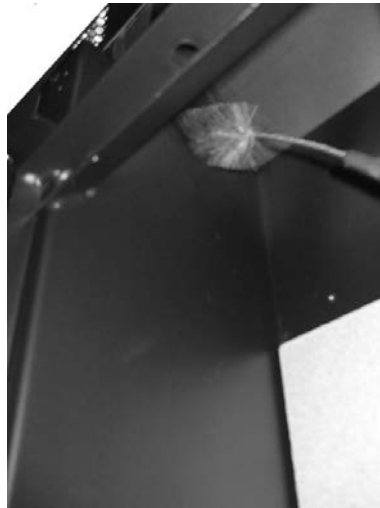

Fig. 96 - Cleaning with a brush 1



Fig. 97 - Clean both the ducts



Fig. 98 - Fume chamber

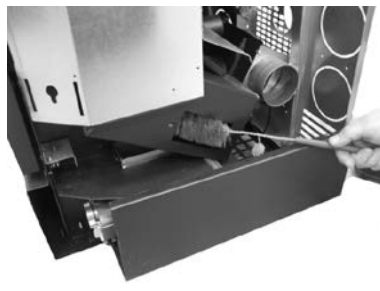

Fig. 99 - Cleaning with a brush 2

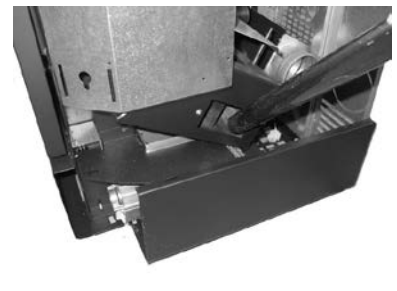

Fig. 100 - Fume chamber cleaning

6.4 FUME CONDUIT CLEANING

The exhaust system must be cleaned every season (or every 1500 operation hours).



Fig. 101 - Fume conduit cleaning



Fig. 102 - Fume conduit (Sfera³ Plus, Sfera³, Globe, Elise³ Plus)

- Remove the side panel.
- Remove the inspection lid of the T-union (see **Fig. 101** and **Fig. 102**).
- Extract the ash which has accumulated in the inner.

- After the cleaning repeat the opposite operation checking the integrity and efficiency of the gasket: if necessary have it replaced by an Authorized Technician.



It is important to sealed the cap othrwise noxiuous fumes will propagate among the room.

6.5 FUME FAN CLEANING

Clean every the year the fume fan from ash or dust which can cause a blade unbalance and a greater noise.



Fig. 103 - Fume fan cleaning: phase 1

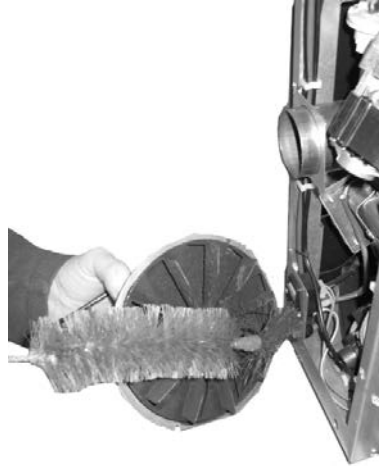

Fig. 104 - Phase 2

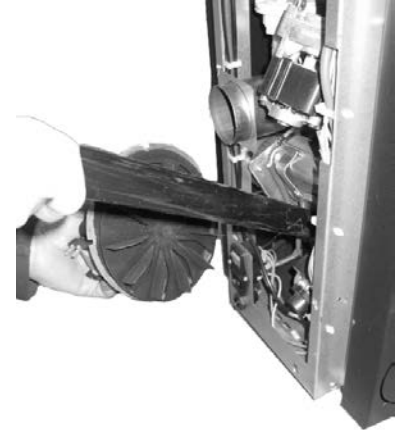

Fig. 105 - Phase 3

- Follow the process as describer in **Fig. 103**, **Fig. 104** and **Fig. 105**.

6.6 ROOM FAN CLEANING

Clean every the year the room fan from ash or dust which can cause a blade unbalance and a greater noise.

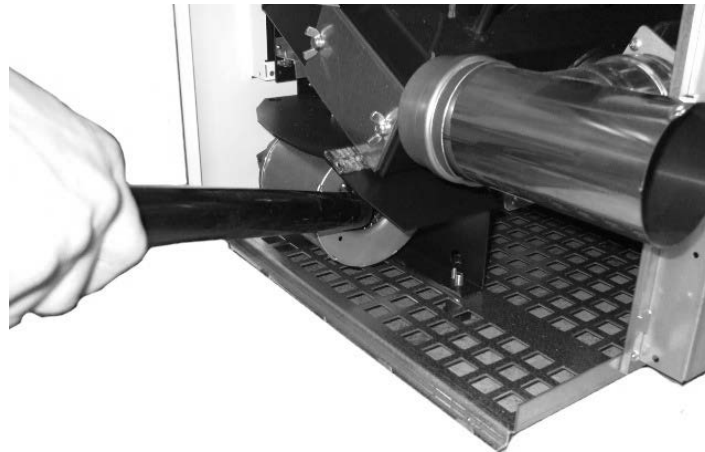

Fig. 106 - Room fan cleaning

- Remove the sides.
- Remove dust build-up using a brush or a vacuum cleaner (see **Fig. 106**).

7 IN CASE OF ANOMALY





7.1 PROBLEM SOLVING



























Before of every Authorized Technician intervention, the same Technician has the duty to check if the parameters of the mother board correspond to those of the table you own.





In case of doubts regarding the use of the stove, please contact ALWAYS the Authorized Technician on order to avoi irreparable damages!

PROBLEM	CAUSE	SOLUTION	INTERVENTION
The control display does not switch on	The stove is without power supply	Check if the plug is connected.	
	Burned protection fuse in the electric socket	Replace the protection fuses in the electric socket (3.15A-250V).	
	Faulty control display	Replace the control display.	
	Faulty flat cable	Replace the flat cable.	
	Faulty electronic board	Replace the mother board.	

PROBLEM	CAUSE	SOLUTION	INTERVENTION
Pellets do not reach the combustion chamber	Empty hopper	Full the hopper.	
	Open fire door or open pellet door	Close fire door and pellet door and check that there are no pellet grains at the gasket level.	
	Clogged stove	Fume chamber cleaning	
	Auger blocked by a foreign object (for example nails)	Clean the auger.	
	The auger geared motor is out of order	Replace the geared motor.	
	Check if on the display there is an "ACTIVE ALARM"	Have the stove checked.	
The fire extinguish and the stove stops	Empty hopper	Full the hopper.	
	Auger blocked by a foreign object (for example nails)	Clean the auger.	
	Bad quality pellets	Try other types of pellets.	
	Pellet drop value too low "phase 1"	Adjust the pellet loading.	
	Check if on the display there is an "ACTIVE ALARM"	Have the stove checked.	

PROBLEM	CAUSE	SOLUTION	INTERVENTION
Flames are weak and orange coloured, pellets do not burn properly and the glass blackens	Not sufficient combustion air	Check as following: probable obstructions of the combustible air inlet from the back or from the bottom of the stove; burning pot obstructed holes with too ash remains. Have the fan blades and auger cleaned.	
	Obstructed exhaust	The exhaust chimney is partially or totally obstructed. Contact an expert stove-repairer who checks the stove from the exhaust up to the chimney pot. Provide immediately for stove cleaning.	
	Obstructed stove	Provide immediately at the inner cleaning of the stove.	
	The fume fan is out of order	The pellets can burn also thanks to chimney flue depression without the aid of the fume fan. Have the fume fan immediately replaced. It can be noxious to health to let the stove running without fume fan.	
The exchanger fan continues to turn even though the stove has just cooled	Faulty fume temperature probe	Replace the fume probe.	
	Faulty mother board	Replace the mother board.	
Ash remains along the stove	Faulty or out of order door gaskets	Replace the gaskets.	
	Not sealed fume pipes	Contact an expert stove-repairer who will immediately provide for sealing the junctions with high-temperature silicone and/or for replacing pipes with those in compliance to current regulations. A not sealed fume channelisation can be noxious to health.	
The stove is at its highest power but does not heat up.	Ambient temperature reached.	The stove is at its minimum value. Increase the desired ambient temperature.	
Stove running and display showing "Smoke Overtemperature"	Reached fume outlet limit temperature	The stove runs at minimum. NO PROBLEM!	
The stove's smoke duct produces condensation	Low smoke temperature	Check that the flue is not clogged.	
		Increase stove power to minimum (pellet drop and fan revs).	
		Install condensation collection cup.	

PROBLEM	CAUSE	SOLUTION	INTERVENTION
Stove running and display showing "SERVICE"	Routine maintenance alert (it does not block the system)	When this flashing message appears upon start-up, it means that the preset operating hours have elapsed before maintenance. Contact the service centre.	
"Pellet reserve enabling" activates with the tank full	Failure to reach the threshold temperature, large or poor quality pellet, clogged fume passage	Increase pellet with "Pellet Recipe" or clean the combustion chamber	

8 TECHNICAL DATAS

8.1 FUSE REPLACEMENT

For fuse replacement in the electric socket which stands on the back of the stove, extract the fuses to change with the aid of a screwdriver for opening the shutter (see **Fig. 107**).

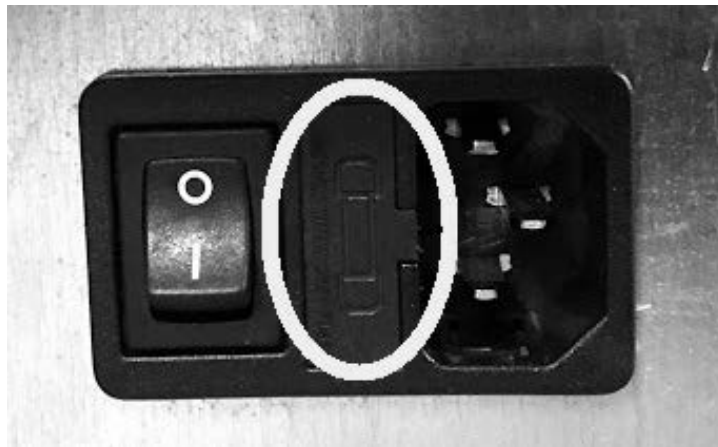

Fig. 107 - Shutter with fuses to remove

8.2 FEATURES

DESCRIPTION	SFERA ³ 11 kW	SFERA ³ PLUS 11 kW	GLOBE AIRTIGHT
WIDTH	53,6 cm	53,6 cm	53,6 cm
DEPTH	57 cm	57 cm	57 cm
HEIGHT	104 cm	104 cm	104 cm
WEIGHT	98 - 108 kg	98 - 108 kg	98 kg
INTRODUCED THERMAL POWER (Min/Max)	3,5 - 12,1 kW	3,5 - 12,3 kW	3,5 - 12,1 kW
NOMINAL THERMAL POWER (Min/Max)	3,3 - 11 kW	3,3 - 11 kW	3,3 - 11 kW
EFFICIENCY (Min/Max)	93,5 - 91 %	93,5 - 89 %	93,5 - 91 %
FLUE GAS TEMPERATURE (Min/Max)	85 - 174 °C	85 - 197 °C	85 - 174 °C
MAXIMUM FLUE GAS FLOW RATE (Min/Max)	3,7 - 7,1 g/s	3,7 - 7,6 g/s	3,7 - 7,1 g/s
CO EMISSIONS (13% O ₂) (Min/Max)	0,022 - 0,0022 %	0,022 - 0,002 %	0,022 - 0,0022 %
OGC EMISSIONS (13% O ₂) (Min/Max)	7 - 2 mg/Nm ³	7 - 2 mg/Nm ³	7 - 2 mg/Nm ³
NOX EMISSIONS (13% O ₂) (Min/Max)	105 - 119 mg/Nm ³	105 - 121 mg/Nm ³	105 - 119 mg/Nm ³
Average CO CONTENT at 13% O ₂ (Min/Max)	268 - 27 mg/Nm ³	268 - 23 mg/Nm ³	268 - 27 mg/Nm ³
Average DUST CONTENT at 13% O ₂ (Min/Max)	11 - 14 mg/Nm ³	11 - 14 mg/Nm ³	11 - 14 mg/Nm ³
FLUE NEGATIVE PRESSURE (Min/Max)	9 - 10 Pa	9 - 12 Pa	9 - 10 Pa
ON SHARED FLUE	NO	NO	NO
FLUE GAS EXHAUST DIAMETER	Ø80 mm	Ø80 mm	Ø80 mm
FUEL	Pellet Ø6-7 mm	Pellet Ø6-7 mm	Pellet Ø6-7 mm
PELLET HEATING CAPACITY	5 kWh/kg	5 kWh/kg	5 kWh/kg
PELLET HUMIDITY	≤ 10%	≤ 10%	≤ 10%
HEATABLE VOLUME 18/20°C Coeff. 0.045 kW (Min/Max)	79 - 264 m ³	79 - 264 m ³	79 - 264 m ³
HOURLY CONSUMPTION (Min/Max)	0,73 - 2,6 kg/h	0,73 - 2,6 kg/h	0,73 - 2,6 kg/h
HOPPER CAPACITY	22 kg	22 kg	22 kg
RANGE (Min/Max)	8,5 - 30 h	8,5 - 30 h	8,5 - 30 h
POWER SUPPLY	230 V - 50 Hz	230 V - 50 Hz	230 V - 50 Hz
ABSORBED POWER (Max)	360 kW	360 kW	360 kW
STARTER RESISTANCE ABSORBED POWER	300 W	300 W	300 W
MINIMUM EXTERNAL AIR VENT (final cross-section)	80 cm ²	80 cm ²	80 cm ²
SEALED CHAMBER STOVE	SI	SI	SI
EXTERNAL AIR VENT FOR SEALED CHAMBER	60 mm	60 mm	60 mm
DISTANCE FROM COMBUSTIBLE MATERIAL (back/side/bottom)	200 / 300 / 0 mm	200 / 300 / 0 mm	200 / 300 / 0 mm
DISTANCE FROM COMBUSTIBLE MATERIAL (ceiling/front)	- / 1000 mm	- / 1000 mm	- / 1000 mm

DESCRIPTION	SIRE ³ PLUS 11 kW	DOGE ³ PLUS 11 kW	ELISE ³ PLUS 11 kW
WIDTH	54,4 cm	55,4 cm	65 cm
DEPTH	52,3 cm	54 cm	60,3 cm
HEIGHT	104,8 cm	105,6 cm	108 cm
WEIGHT	131 kg	118 kg	138 kg
INTRODUCED THERMAL POWER (Min/Max)	3,5 - 12,3 kW	3,5 - 12,3 kW	3,5 - 12,3 kW
NOMINAL THERMAL POWER (Min/Max)	3,3 - 11 kW	3,3 - 11 kW	3,3 - 11 kW
EFFICIENCY (Min/Max)	93,5 - 89 %	93,5 - 89 %	93,5 - 89 %
FLUE GAS TEMPERATURE (Min/Max)	85 - 197 °C	85 - 197 °C	85 - 197 °C
MAXIMUM FLUE GAS FLOW RATE (Min/Max)	3,7 - 7,6 g/s	3,7 - 7,6 g/s	3,7 - 7,6 g/s
CO EMISSIONS (13% O ₂) (Min/Max)	0,022 - 0,002 %	0,022 - 0,002 %	0,022 - 0,002 %
OGC EMISSIONS (13% O ₂) (Min/Max)	7 - 2 mg/Nm ³	7 - 2 mg/Nm ³	7 - 2 mg/Nm ³
NOX EMISSIONS (13% O ₂) (Min/Max)	105 - 121 mg/Nm ³	105 - 121 mg/Nm ³	105 - 121 mg/Nm ³
Average CO CONTENT at 13% O ₂ (Min/Max)	268 - 23 mg/Nm ³	268 - 23 mg/Nm ³	268 - 23 mg/Nm ³
Average DUST CONTENT at 13% O ₂ (Min/Max)	11 - 14 mg/Nm ³	11 - 14 mg/Nm ³	11 - 14 mg/Nm ³
FLUE NEGATIVE PRESSURE (Min/Max)	9 - 12 Pa	9 - 12 Pa	9 - 12 Pa
ON SHARED FLUE	NO	NO	NO
FLUE GAS EXHAUST DIAMETER	Ø80 mm	Ø80 mm	Ø80 mm
FUEL	Pellet Ø6-7 mm	Pellet Ø6-7 mm	Pellet Ø6-7 mm
PELLET HEATING CAPACITY	5 kWh/kg	5 kWh/kg	5 kWh/kg
PELLET HUMIDITY	≤ 10%	≤ 10%	≤ 10%
HEATABLE VOLUME 18/20°C Coeff. 0.045 kW (Min/Max)	79 - 264 m ³	79 - 264 m ³	79 - 264 m ³
HOURLY CONSUMPTION (Min/Max)	0,73 - 2,6 kg/h	0,73 - 2,6 kg/h	0,73 - 2,6 kg/h
HOPPER CAPACITY	22 kg	22 kg	22 kg
RANGE (Min/Max)	8,5 - 30 h	8,5 - 30 h	8,5 - 30 h
POWER SUPPLY	230 V - 50 Hz	230 V - 50 Hz	230 V - 50 Hz
ABSORBED POWER (Max)	360 kW	360 kW	360 kW
STARTER RESISTANCE ABSORBED POWER	300 W	300 W	300 W
MINIMUM EXTERNAL AIR VENT (final cross-section)	80 cm ²	80 cm ²	80 cm ²
SEALED CHAMBER STOVE	SI	SI	SI
EXTERNAL AIR VENT FOR SEALED CHAMBER	60 mm	60 mm	60 mm
DISTANCE FROM COMBUSTIBLE MATERIAL (back/side/ bottom)	200 / 300 / 0 mm	200 / 300 / 0 mm	200 / 300 / 0 mm
DISTANCE FROM COMBUSTIBLE MATERIAL (ceiling/front)	- / 1000 mm	- / 1000 mm	- / 1000 mm

DESCRIPTION	VEGA AIRTIGHT	TREND AIRTIGHT	PRINCE ³ 11 kW
WIDTH	54 cm	54 cm	53,6 cm
DEPTH	54 cm	54 cm	54 cm
HEIGHT	105 cm	105 cm	105,8 cm
WEIGHT	104 kg	104 kg	104,5 kg
INTRODUCED THERMAL POWER (Min/Max)	3,5 - 12,3 kW	3,5 - 12,3 kW	3,5 - 12,1 kW
NOMINAL THERMAL POWER (Min/Max)	3,3 - 11 kW	3,3 - 11 kW	3,3 - 11 kW
EFFICIENCY (Min/Max)	93,5 - 89 %	93,5 - 89 %	93,5 - 91 %
FLUE GAS TEMPERATURE (Min/Max)	85 - 197 °C	85 - 197 °C	85 - 174 °C
MAXIMUM FLUE GAS FLOW RATE (Min/Max)	3,7 - 7,6 g/s	3,7 - 7,6 g/s	3,7 - 7,1 g/s
CO EMISSIONS (13% O ₂) (Min/Max)	0,022 - 0,002 %	0,022 - 0,002 %	0,022 - 0,0022 %
OGC EMISSIONS (13% O ₂) (Min/Max)	7 - 2 mg/Nm ³	7 - 2 mg/Nm ³	7 - 2 mg/Nm ³
NOX EMISSIONS (13% O ₂) (Min/Max)	105 - 121 mg/Nm ³	105 - 121 mg/Nm ³	105 - 119 mg/Nm ³
Average CO CONTENT at 13% O ₂ (Min/Max)	268 - 23 mg/Nm ³	268 - 23 mg/Nm ³	268 - 27 mg/Nm ³
Average DUST CONTENT at 13% O ₂ (Min/Max)	11 - 14 mg/Nm ³	11 - 14 mg/Nm ³	11 - 14 mg/Nm ³
FLUE NEGATIVE PRESSURE (Min/Max)	9 - 12 Pa	9 - 12 Pa	9 - 10 Pa
ON SHARED FLUE	NO	NO	NO
FLUE GAS EXHAUST DIAMETER	Ø80 mm	Ø80 mm	Ø80 mm
FUEL	Pellet Ø6-7 mm	Pellet Ø6-7 mm	Pellet Ø6-7 mm
PELLET HEATING CAPACITY	5 kWh/kg	5 kWh/kg	5 kWh/kg
PELLET HUMIDITY	≤ 10%	≤ 10%	≤ 10%
HEATABLE VOLUME 18/20°C Coeff. 0.045 kW (Min/Max)	79 - 264 m ³	79 - 264 m ³	79 - 264 m ³
HOURLY CONSUMPTION (Min/Max)	0,73 - 2,6 kg/h	0,73 - 2,6 kg/h	0,73 - 2,6 kg/h
HOPPER CAPACITY	22 kg	22 kg	22 kg
RANGE (Min/Max)	8,5 - 30 h	8,5 - 30 h	8,5 - 30 h
POWER SUPPLY	230 V - 50 Hz	230 V - 50 Hz	230 V - 50 Hz
ABSORBED POWER (Max)	360 kW	360 kW	360 kW
STARTER RESISTANCE ABSORBED POWER	300 W	300 W	300 W
MINIMUM EXTERNAL AIR VENT (final cross-section)	80 cm ²	80 cm ²	80 cm ²
SEALED CHAMBER STOVE	SI	SI	SI
EXTERNAL AIR VENT FOR SEALED CHAMBER	60 mm	60 mm	60 mm
DISTANCE FROM COMBUSTIBLE MATERIAL (back/side/ bottom)	200 / 300 / 0 mm	200 / 300 / 0 mm	200 / 300 / 0 mm
DISTANCE FROM COMBUSTIBLE MATERIAL (ceiling/front)	- / 1000 mm	- / 1000 mm	- / 1000 mm

DESCRIPTION	PRINCE ³ PLUS 11 kW	VENUS ³ PLUS 12,5 kW	JOY AIRTIGHT 12,5 kW
WIDTH	53,6 cm	63,6 cm	58,5 cm
DEPTH	54 cm	55,4 cm	55 cm
HEIGHT	105,8 cm	111,2 cm	111,2 cm
WEIGHT	105,5 kg	127 - 180 kg	116 kg
INTRODUCED THERMAL POWER (Min/Max)	3,5 - 12,3 kW	3,5 - 14,1 kW	3,5 - 14,1 kW
NOMINAL THERMAL POWER (Min/Max)	3,3 - 11 kW	3,3 - 12,5 kW	3,3 - 12,5 kW
EFFICIENCY (Min/Max)	93,5 - 89 %	93,5 - 87,5 %	93,5 - 87,5 %
FLUE GAS TEMPERATURE (Min/Max)	85 - 197 °C	85 - 238 °C	85 - 238 °C
MAXIMUM FLUE GAS FLOW RATE (Min/Max)	3,7 - 7,6 g/s	3,8 - 6,9 g/s	3,8 - 6,9 g/s
CO EMISSIONS (13% O ₂) (Min/Max)	0,022 - 0,002 %	0,022 - 0,009 %	0,022 - 0,009 %
OGC EMISSIONS (13% O ₂) (Min/Max)	7 - 2 mg/Nm ³	7 - 7 mg/Nm ³	7 - 7 mg/Nm ³
NOX EMISSIONS (13% O ₂) (Min/Max)	105 - 121 mg/Nm ³	105 - 136 mg/Nm ³	105 - 136 mg/Nm ³
Average CO CONTENT at 13% O ₂ (Min/Max)	268 - 23 mg/Nm ³	268 - 116 mg/Nm ³	268 - 116 mg/Nm ³
Average DUST CONTENT at 13% O ₂ (Min/Max)	11 - 14 mg/Nm ³	11 - 15 mg/Nm ³	11 - 15 mg/Nm ³
FLUE NEGATIVE PRESSURE (Min/Max)	9 - 12 Pa	9 - 11 Pa	9 - 11 Pa
ON SHARED FLUE	NO	NO	NO
FLUE GAS EXHAUST DIAMETER	Ø80 mm	Ø80 mm	Ø80 mm
FUEL	Pellet Ø6-7 mm	Pellet Ø6-7 mm	Pellet Ø6-7 mm
PELLET HEATING CAPACITY	5 kWh/kg	5 kWh/kg	5 kWh/kg
PELLET HUMIDITY	≤ 10%	≤ 10%	≤ 10%
HEATABLE VOLUME 18/20°C Coeff. 0.045 kW (Min/Max)	79 - 264 m ³	79 - 300 m ³	79 - 300 m ³
HOURLY CONSUMPTION (Min/Max)	0,73 - 2,6 kg/h	0,73 - 3,0 kg/h	0,73 - 3,0 kg/h
HOPPER CAPACITY	22 kg	26,5 kg	26,5 kg
RANGE (Min/Max)	8,5 - 30 h	36 - 9 h	36 - 9 h
POWER SUPPLY	230 V - 50 Hz	230 V - 50 Hz	230 V - 50 Hz
ABSORBED POWER (Max)	360 kW	360	360
STARTER RESISTANCE ABSORBED POWER	300 W	300	300
MINIMUM EXTERNAL AIR VENT (final cross-section)	80 cm ²	80 cm ²	80 cm ²
SEALED CHAMBER STOVE	SI	SI	SI
EXTERNAL AIR VENT FOR SEALED CHAMBER	60 mm	60 mm	60 mm
DISTANCE FROM COMBUSTIBLE MATERIAL (back/side/bottom)	200 / 300 / 0 mm	200 / 300 / - mm	200 / 300 / - mm
DISTANCE FROM COMBUSTIBLE MATERIAL (ceiling/front)	- / 1000 mm	- / 1000 mm	- / 1000 mm

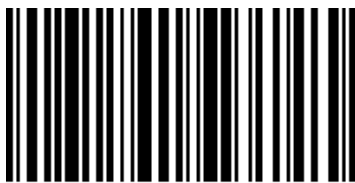

890181288

Rev. 00 - 2018

CADEL srl
31025 S. Lucia di Piave - TV
Via Foresto sud, 7 - Italy
Tel. +39.0438.738669
Fax +39.0438.73343

www.cadelsrl.com
www.free-point.it