

USER MANUAL

PELLET THERMOSTOVE



©2020 CADEL srl | All rights reserved - Tutti i diritti riservati

SATURN0 16 - 24

TECHNICAL DOCUMENTATION FOR LOCAL SPACE HEATERS ACCORDING TO COMMISSION REGULATIONS (EU) 2015/1185 - (EU) 2015/1186 (PRODUCT FICHE)

| | | | |
|---|--|-------|--------------------|
| Manufacturer | CADEL srl - Via Foresto Sud 7 - 31025 Santa Lucia di Piave (TV) - Italy | | |
| Trademark: model identifier | CADEL: SATURNO 16 | | |
| Description | Pellet stove | | |
| Indirect heating functionality | Yes | | |
| Direct heat output | 5 kW | | |
| Indirect heat output | 13 kW | | |
| CPR harmonised standard | EN 14785 | | |
| Notified body | IMQ S.P.A. (N.B.0051) | | |
| Preferred fuel (unique) | Compressed wood with moisture content < 12 % | YES | |
| | Wood logs with moisture content ≤ 25 % | NO | |
| | Other woody biomass | NO | |
| η_s | | 90 | % |
| EEl | | 132 | - |
| Energy Efficiency Class (A++ to G scale) | | A++ | |
| Space heating emissions at nominal heat output | PM (al 13% O ₂) | 12 | mg/Nm ³ |
| | OGC (al 13% O ₂) | 2 | mg/Nm ³ |
| | CO (al 13% O ₂) | 111 | mg/Nm ³ |
| | NO _x (al 13% O ₂) | 114 | mg/Nm ³ |
| Space heating emissions at minimum heat output <i>Only required if correction factors F(2) or F(3) are applied</i> | PM (al 13% O ₂) | 19 | mg/Nm ³ |
| | OGC (al 13% O ₂) | 4 | mg/Nm ³ |
| | CO (al 13% O ₂) | 275 | mg/Nm ³ |
| | NO _x (al 13% O ₂) | 84 | mg/Nm ³ |
| Heat output | Nominal heat output (P _{nom}) | 18 | kW |
| | Minimum heat output (indicative) (P _{min}) | 5,8 | kW |
| Useful efficiency (NCV as received) | Useful efficiency at nominal heat output ($\eta_{th, nom}$) | 94,2 | % |
| | Useful efficiency at minimum heat output (indicative) ($\eta_{th, min}$) | 95,9 | % |
| Auxiliary electricity consumption | At nominal heat output (el _{max}) | 0,125 | kW |
| | At minimum heat output (el _{min}) | 0,085 | kW |
| | In standby mode (el _{sb}) | 0,001 | kW |
| Type of heat output/room temperature control (select one) | Single stage heat output, no room temperature control | NO | |
| | Two or more manual stages, no room temperature control | NO | |
| | With mechanic thermostat room temperature control | NO | |
| | With electronic room temperature control | NO | |
| | With electronic room temperature control plus day timer | NO | |
| Other control options (multiple selections possible) | With electronic room temperature control plus week timer | YES | |
| | Room temperature control, with presence detection | NO | |
| | Room temperature control, with open window detection | NO | |
| Permanent pilot flame power requirement | With distance control option | YES | |
| | Pilot flame power requirement (if applicable) (P _{pilot}) | N.A. | kW |

Observe the specific precautions for installation, assembly and maintenance indicated in the manual accompanying the product.

| | |
|------------------------|--|
| Issue date: 18.11.2021 | <p style="text-align: center;">CADEL s.r.l. Via Foresto Sud, 7 - 31025 SANTA LUCIA DI PIAVE (TV) Tel. 0438 738869 - Fax 0438 73343 Partita IVA 03201180265 R.E.A. TV 227665 - Reg. Soc. Trib. TV 185949</p> <p style="text-align: center;">Legal Representative</p> |
|------------------------|--|

TECHNICAL DOCUMENTATION FOR LOCAL SPACE HEATERS ACCORDING TO COMMISSION REGULATIONS (EU) 2015/1185 - (EU) 2015/1186 (PRODUCT FICHE)

| | | | |
|---|--|-------|--------------------|
| Manufacturer | CADEL srl - Via Foresto Sud 7 - 31025 Santa Lucia di Piave (TV) - Italy | | |
| Trademark: model identifier | CADEL: SATURNO 24 | | |
| Description | Pellet stove | | |
| Indirect heating functionality | YES | | |
| Direct heat output | 5,7 kW | | |
| Indirect heat output | 19 kW | | |
| CPR harmonised standard | EN 14785 | | |
| Notified body | IMQ S.P.A. (N.B.0051) | | |
| Preferred fuel (unique) | Compressed wood with moisture content < 12 % | YES | |
| | Wood logs with moisture content ≤ 25 % | NO | |
| | Other woody biomass | NO | |
| η_s | | 89 | % |
| EEl | | 131 | - |
| Energy Efficiency Class (A++ to G scale) | | A++ | |
| Space heating emissions at nominal heat output | PM (al 13% O ₂) | 15 | mg/Nm ³ |
| | OGC (al 13% O ₂) | 2 | mg/Nm ³ |
| | CO (al 13% O ₂) | 148 | mg/Nm ³ |
| | NO _x (al 13% O ₂) | 110 | mg/Nm ³ |
| Space heating emissions at minimum heat output <i>Only required if correction factors F(2) or F(3) are applied</i> | PM (al 13% O ₂) | 19 | mg/Nm ³ |
| | OGC (al 13% O ₂) | 4 | mg/Nm ³ |
| | CO (al 13% O ₂) | 275 | mg/Nm ³ |
| | NO _x (al 13% O ₂) | 84 | mg/Nm ³ |
| Heat output | Nominal heat output (P _{nom}) | 24,7 | kW |
| | Minimum heat output (indicative) (P _{min}) | 5,8 | kW |
| Useful efficiency (NCV as received) | Useful efficiency at nominal heat output ($\eta_{th, nom}$) | 93,3 | % |
| | Useful efficiency at minimum heat output (indicative) ($\eta_{th, min}$) | 95,9 | % |
| Auxiliary electricity consumption | At nominal heat output (el _{max}) | 0,144 | kW |
| | At minimum heat output (el _{min}) | 0,085 | kW |
| | In standby mode (el _{sb}) | 0,001 | kW |
| Type of heat output/room temperature control (select one) | Single stage heat output, no room temperature control | NO | |
| | Two or more manual stages, no room temperature control | NO | |
| | With mechanic thermostat room temperature control | NO | |
| | With electronic room temperature control | NO | |
| | With electronic room temperature control plus day timer | NO | |
| Other control options (multiple selections possible) | With electronic room temperature control plus week timer | YES | |
| | Room temperature control, with presence detection | NO | |
| | Room temperature control, with open window detection | NO | |
| Permanent pilot flame power requirement | With distance control option | YES | |
| | Pilot flame power requirement (if applicable) (P _{pilot}) | N.A. | kW |

Observe the specific precautions for installation, assembly and maintenance indicated in the manual accompanying the product.

| | | |
|------------------------|----------------------|---|
| Issue date: 18.11.2021 | Legal Representative | CADEL s.r.l. Via Foresto Sud, 7 - 31025 SANTA LUCIA DI PIAVE (TV) Tel. 0438 738869 - Fax 0438 73343 Partita IVA 03201180265 R.E.A. TV 227665 - Reg. Soc. Trib. TV 185949 |
|------------------------|----------------------|---|

DISPOSAL OF MATERIALS

WARNINGS FOR THE CORRECT DISPOSAL OF THE PRODUCT

The owner is the sole party responsible for demolishing and disposing of the product. This must be performed in compliance with laws related to safety and environmental protection in force in his/her country.

At the end of its working life, the product must not be disposed of as urban waste.

It must be taken to a special differentiated waste collection centre set up by the local authorities or to a retailer that provides this service.

Separating and recycling prevents potential negative effects on the environment and health (often caused by inappropriately disposing of product parts). It also allows materials to be recovered in order to obtain significant savings in energy and resources.

The following table and the exploded view it refers to highlight the main components that can be found in the device and indications on how to separate and dispose of them correctly when no longer used.

More specifically, the electric and electronic components must be separated and disposed of in authorised centres, in compliance with the WEEE directive 2012/19/EU and the relative national transpositions.

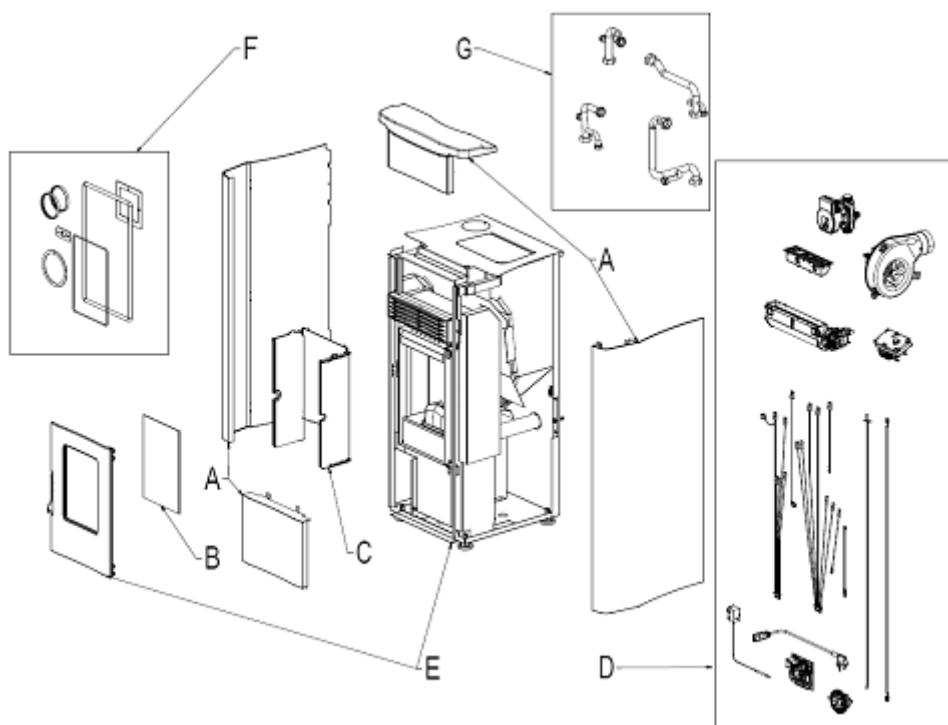

Exploded drawing







| LEGENDA | WHERE TO DISPOSE | MATERIALS |
|----------------------|---|---|
| A. OUTER CLADDING | If there is any, to be disposed of separately based on the material used: | Metal |
| | | Glass |
| | | Tiles or ceramics |
| | | Stone |
| B. GLASS DOORS | If there is any, to be disposed of separately based on the material used: | Glass ceramic (fire door): to be disposed of with inert or mixed waste |
| | | Tempered glass (oven door): to be disposed of with glass |
| C. INTERIOR CLADDING | If there is any, to be disposed of separately based on the material used: | Metal |
| | | Refractory materials |
| | | Insulating panels |
| | | Vermiculite |
| | | Insulation, vermiculite and refractory materials that have come into contact with flames or exhaust gases (dispose of in mixed waste) |

| LEGENDA | WHERE TO DISPOSE | MATERIALS |
|---------------------------------------|--|--|
| D. ELECTRIC AND ELECTRONIC COMPONENTS | To be disposed of separately in authorised centres, as indicated in the WEEE directive 2012/19/EU and the relative national transposition. | Wiring, motors, fans, circulators, display panels, sensors ignition plug, electronic cards, batteries. |
| E. METAL STRUCTURE | To be disposed of separately with metal | - |
| F. COMPONENTS THAT CANNOT BE RECYCLED | To be disposed of with mixed waste | E.G.: Gaskets, rube piping, silicone or fibres, plastic. |
| G. HYDRAULIC COMPONENTS | Piping, fittings, expansion vessel, valves. If there are any, to be disposed of separately based on the material they are made of: | Copper |
| | | Brass |
| | | Stainless steel |
| | | Other materials |

INSTRUCTIONS FOR PACKAGING DISPOSAL

The material that the appliance's packaging is made of must be managed correctly, in order to make collection, reuse, recovery and recycling easier, where possible.





The table below illustrates the possible components that the packaging is made of, and the relative instructions for correct disposal.

| DESCRIPTION | CODE MATERIAL | SYMBOL | DIRECTIONS FOR COLLECTION |
|--|--------------------------------|--|--|
| - WOOD BED - WOOD CAGE - WOOD PALLET | WOOD FOR 50 |  | SORTED waste collection |
| | | | WOOD |
| | | | Check with the competent body on how to dispose of this packaging at the recycling depot |
| - CARDBOARD BOX - CARDBOARD CORNER - CARDBOARD SHEET | CORRUGATED CARDBOARD PAP 20 |  | SORTED waste collection |
| | | | PAPER |
| | | | Check the instructions of the competent body |
| - APPLIANCE BAG - BAG OF ACCESSORIES - BUBBLE WRAP - PROTECTIVE SHEET - LABELS | POLYETHYLENE LD PE 04 |  | SORTED waste collection |
| | | | PLASTIC |
| | | | Check the instructions of the competent body |
| - POLYSTYRENE - FOAM PEANUTS | POLYSTYRENE PS 6 |  | SORTED waste collection |
| | | | PLASTIC |
| | | | Check the instructions of the competent body |
| - STRAP - TAPE | POLYPROPYLENE PP 5 |  | SORTED waste collection |
| | | | PLASTIC |
| | | | Check the instructions of the competent body. |
| - SCREWS - STAPLES FOR STRAP - FASTENING BRACKET | IRON FE 40 |  | SORTED waste collection |
| | | | METAL |
| | | | Check with the competent body on how to dispose of this packaging at the recycling depot |

SUMMARY

| | | |
|-----------|--|-----------|
| 1 | MANUAL SIMBOLOGY | 3 |
| 2 | DEAR CUSTOMER | 3 |
| 3 | CAUTIONS | 3 |
| 4 | SAFETY REQUIREMENTS | 4 |
| 5 | WARRANTY CONDITIONS | 5 |
| 5.1 | PRODUCT PERFORMANCE CHECKS | 6 |
| 6 | SPARE PARTS | 6 |
| 7 | WARNINGS FOR THE CORRECT DISPOSAL OF THE PRODUCT | 7 |
| 7.1 | INFORMATION FOR MANAGEMENT OF ELECTRIC AND ELECTRONIC APPLIANCE WASTE CONTAINING BATTERIES OR ACCUMULATORS | 7 |
| 8 | WI-FI - BLUETOOTH CONNECTION | 8 |
| 8.1 | EASY CONNECT PLUS..... | 8 |
| 8.2 | NAVEL STAND ALONE | 8 |
| 9 | USE | 9 |
| 9.1 | INTRODUCTION | 9 |
| 9.2 | CONTROL PANEL DISPLAY | 10 |
| 9.3 | MAIN MENU | 10 |
| 9.4 | SETTINGS MENU..... | 10 |
| 9.5 | AUTO ECO MODE (SEE SECTION F-G)..... | 15 |
| 9.6 | PROGRAMMED MODE (TIMER) - MAIN MENU | 15 |
| 9.7 | NOTES FOR TIMER OPERATION..... | 16 |
| 9.8 | SLEEP FUNCTION (MAIN MENU) | 16 |
| 10 | FIRST IGNITION WARNINGS | 17 |
| 10.1 | START UP | 17 |
| 10.2 | GENERAL WARNINGS | 17 |
| 10.3 | POWER OUTPUT | 18 |
| 10.4 | ADJUSTMENTS MENU | 18 |
| 10.5 | NORMAL SHUTDOWN (ON THE PANEL: OFF WITH FLASHING FLAME)..... | 18 |
| 10.6 | POWER FAILURE..... | 19 |
| 10.7 | FAILED IGNITION | 19 |
| 11 | RECOMMENDATIONS FOR SAFE USE | 19 |
| 12 | FUEL | 20 |
| 12.1 | FUEL | 20 |
| 12.2 | PELLET SUPPLY | 20 |
| 12.3 | LOADING THE PELLETS | 21 |
| 12.4 | USER TRAINING..... | 21 |
| 14 | SAFETY DEVICES AND ALARMS | 22 |
| 14.1 | SAFETY DEVICES | 22 |
| 14.2 | PRESSURE SWITCH..... | 22 |
| 14.3 | SMOKE TEMPERATURE PROBE | 22 |
| 14.4 | CONTACT THERMOSTAT IN THE FUEL HOPPER..... | 22 |
| 14.5 | ELECTRICAL SAFETY | 22 |
| 14.6 | SMOKE FAN | 22 |
| 14.7 | GEAR MOTOR..... | 22 |
| 14.8 | TEMPORARY POWER CUT..... | 22 |
| 14.9 | FAILED START-UP | 22 |
| 14.10 | BLACKOUT WITH THE BOILER ON | 22 |
| 14.11 | BLACKOUT OF MORE THAN 10" DURING STOVE SHUTDOWN | 23 |
| 14.12 | CONTACT THERMOSTAT IN THE BOILER..... | 23 |
| 14.13 | WATER TEMPERATURE PROBE..... | 23 |
| 14.14 | ANTIFREEZE FUNCTION..... | 23 |
| 14.15 | PUMP ANTI-SEIZURE FUNCTION | 23 |
| 14.16 | ALARM ALERTS | 23 |
| 14.17 | ALARM RESET | 24 |
| 15 | ROUTINE MAINTENANCE | 25 |
| 15.1 | INTRODUCTION | 25 |
| 15.2 | BEFORE EACH START-UP | 25 |
| 15.3 | HOPPER CLEANING | 26 |
| 15.4 | DAILY OR WEEKLY CLEANING PERFORMED BY THE USER | 26 |
| 15.5 | CLEANING THE GLASS | 27 |
| 15.6 | CLEAN THE EXCHANGER AND THE COMPARTMENT BENEATH THE BRAZIER..... | 27 |
| 15.7 | PIPE UNIT CLEANING..... | 27 |
| 15.8 | FUME PIPES ANNUAL CLEANING | 28 |
| 15.9 | GENERAL CLEANING..... | 28 |
| 15.10 | CLEANING OF PAINTED METAL PANELS | 28 |
| 15.11 | CLEANING OF CERAMIC AND STONE PANELS | 28 |
| 15.12 | FUME PIPES ANNUAL CLEANING | 28 |
| 15.13 | GENERAL CLEANING..... | 28 |
| 15.14 | CLEANING OF PAINTED METAL PANELS | 28 |
| 15.15 | CLEANING OF CERAMIC AND STONE PANELS | 29 |
| 15.16 | SWITCHING OFF AT THE END OF THE SEASON | 29 |
| 15.17 | CHECKING THE INNER COMPONENTS..... | 29 |
| 16 | IN CASE OF ANOMALY | 30 |
| 16.1 | PROBLEM SOLVING | 30 |
| 16.2 | PROBLEM SOLVING (THERMOSTOVE) | 34 |

1 MANUAL SIMBOLOGY

| | |
|---|--|
|  | USER |
|  | AUTHORISED TECHNICIAN (ONLY to interpret or the Stove-manufacturer or the Authorized Technician of Technical Assistance Service approved by the Stove-manufacturer) |
|  | SPECIALIZED STOVE-REPAIRER |
|  | CAUTION: READ CAREFULLY THE NOTE |
|  | CAUTION: DANGER OR IRREVERSIBLE DAMAGE POSSIBILITY |

- The icons with the stylized figures indicates whom the subject dealt in the paragraph is addressed to (between the User and/or the Authorized Technician and/or the Specialized Stove-repairer).
- WARNING symbols indicates an important note.

2 DEAR CUSTOMER

- Dear Customer,
- Our products are designed and manufactured in compliance with European regulations harmonised with Regulation (EU) no. 305/2011 for construction products (EN13240 for wood-burning stoves, EN14785 for pellet-burning appliances, EN13229 for fireplaces/wood-burning inserts and EN 12815 for wood-burning range cookers), with high quality materials and extensive experience in transformation processes. The products also comply with the essential requirements of Directive 2009/125/EC (Eco Design) and, where applicable, Directives 2014/35/EU (Low Voltage), 2014/30/EU (Electromagnetic Compatibility), 2014/53/EU (Radio Frequency), 2011/65/EU (RoHS).
- Read carefully the instruction contained in this manual to obtain the best efficiency.
- This instruction manual is an integral part of the product: make sure it is delivered with the appliance also in case of sold to others. In case of loss please ask a copy to your local Technical Assistance Service.



In Italy biomass system installation below 35 kW must comply with MD 37/08. Every qualified installer who own these requirements, has to issue the certificate of conformity for the installed system ("system" means: stove + chimney + air inlet).

- According to (EU) No. 305/2011 regulation, the "Declaration of Performance" and "Declaration of Conformity" are available online at the web sites:
 - www.cadelsrl.com
 - www.free-point.it
 - www.pegasoheating.com

3 CAUTIONS

- All the pictures carried in this manual are only for indicative and explanatory purpose and could therefore slightly differ from your appliance.
- The referring appliance is those you purchased.
- In case of doubts or difficulties in the comprehension or for problems not described in this manual, please promptly contact your distributor or installer.



- Installation, electrical connection, functional verification and maintenance must only be performed by qualified or authorised personnel.
- Live electrical parts: disconnect the product from the 230V power supply before performing any maintenance operation. Only power the product after completing assembly.
- Special maintenance must only be performed by authorised and qualified personnel.
- All local regulations, including those referring to national European standards, must be respected during appliance installation.
- The manufacturer declines any responsibility in case of installation which are not in compliance with current regulations, in case of a wrong room ventilation system, in case of an electric connection which is not in compliance with regulations and in case of a wrong use of the appliance.
- It is forbidden to install the stove in bedrooms, bathrooms and in rooms used for storing combustible materials and in one-room flats.
- The installation in one-room flats is allowed if they are in sealed chamber.
- In any case the stove must not be installed in rooms where it can get in touch with water or water splashes because this can cause burn hazards and short-circuit.
- Please check that the floor has an adequate load capacity. If the existing one does not satisfy this requirement, appropriate measure should be provided (for example a plate for distributing the load).
- For safety fire regulations the distances from flammable or sensible to heat objects (sofas, pieces of furniture, wooden covering, etc...) must be respected.
- If there are highly flammable objects (curtains, fitted carpet, etc...), all these distances must be further increased with 1 meter.
- If the floor is made of combustible material, we recommend using a protector made of incombustible material (steel, glass, etc.) that also protects the front part from any falling burnt particles during cleaning.
- The electrical cable must not get in touch with the fume exhaust pipe and nor with every other part of the stove.
- The user, or whoever is operating the product, must read and fully understand the contents of this installation and use guide before performing any operation. Errors or incorrect settings can cause hazardous conditions and/or poor operation.
- The type of fuel to use is only the pellets.
- Do not use the appliance as waste incinerator.
- Do not place laundry on the product to dry. Any clothes horses or similar objects must be kept at a safe distance from the product. Fire hazard.
- It is forbidden to operate the product with the door open or the glass broken.
- It is forbidden to modify the appliance without authorization.
- Do not use flammable liquids during the ignition (alcohol, petrol, oil, etc...).
- After a failed ignition the burning pot must be empty from the amassed pellets, before starting the stove up again.
- The pellet hopper must always be closed with its own lid.
- Before of every intervention leave the fire completely extinguish till the cooling and always disconnect the plug from the electric socket.
- This appliance can be used by children aged from 8 years and above and persons with reduced physical, sensory or mental capabilities or lack of experience and knowledge if they have been given supervision or instruction concerning use of the appliance in a safe way and understand the hazards involved. Children shall not play with the appliance. Cleaning and user maintenance shall not be made by children without supervision.
- Packaging are not toys and could cause suffocation or strangulation and other health hazards! People (children included) with reduced mobility, psychological diseases or without

experience and knowledge must be kept away from packaging. The stove is not a toy.

- Children must be constantly overseen in order to assure that they do not play with the appliance.
- During its running, the stove reaches high temperatures: keep away children and animals and for your safety please use appropriate fireproof devices, such as heat-protecting gloves.
- The chimney flue must be cleaned, since the soot and unburnt oil deposits reduce its section so blocking the draught. In great quantities they can flare up.
- If the pellets are of bad quality (if contains sizing agents, oils, varnishes, plastic remains or if it is mealy), deposits will form along pellets drop pipe during the running. When the stove is switched off, these remains could form little hot coals that rising along the pipe could reach the pellets on the hopper burning them and creating a thick and harmful smoke inside the room. Please always keep the hopper closed with its own lid. If the pipe is sooty, please clean it.
- In case it would be necessary to extinguish the fire emitted by the stove or by the chimney flue, use a fire-extinguisher or contact the firemen. **Do not** use water to extinguish the fire inside the burning pot.
- Shut the stove down in the event of a breakdown or bad running and contact the specialised technician immediately.
- Pellets must not be fed manually into the burner - this wrong behaviour can generate an abnormal amount of unburned gas, with a risk of explosion in the chamber.
- Accumulated unburnt pellets in the burner after a failed ignitions must be removed before lighting.
- **PROCEDURE TO FOLLOW IN THE EVENT OF SMOKE IN THE ROOM OR AN EXPLOSION DAMAGING THE DEVICE: SWITCH IT OFF, AIR OUT THE ROOM AND IMMEDIATELY CONTACT THE INSTALLATION/CUSTOMER SERVICE TECHNICIAN.**

5 WARRANTY CONDITIONS

The company guarantees the product, **with the exception of elements subject to normal wear** listed below, for a period of **2 (two) years** from the date of purchase attested by:

- a document to serve as proof of purchase (invoice and/or receipt) that shows the name of the vendor and the date on which the purchase was made;
- forwarding of the completed certificate of guarantee within 8 days of purchase.

Furthermore, the product must be installed and started by specialised personnel who must, where provided, issue a declaration of conformity of the plant and of the proper functioning of the product, for the warranty to be valid and effective.

We recommend testing the product before completion with the relative finishes (claddings, painting of walls, etc.).

Installations not meeting the current standards, improper use and lack of maintenance as expected by the manufacturer, void the product warranty.

The guarantee is valid on the condition that the instructions and warnings contained in the use and maintenance manual are observed, and therefore the product is used correctly.

The replacement of the entire system or the repair of one of its components does not extend the guarantee period, and the original expiry date remains unchanged.

The guarantee covers the replacement or free repair **of parts recognised as being faulty at source due to manufacturing defects**.

To benefit from the guarantee, in the event of a fault, the customer must have the guarantee certificate and present it with the proof of purchase document to the Technical Assistance Office.

The guarantee does not cover malfunctions and/or damage to the appliance that arise due to the following causes:

- Damage caused during transportation or relocation.
- All parts that develop faults due to negligence or improper use, incorrect maintenance, installation that does not comply with the manufacturer's instructions (always refer to the installation and use manual provided with the appliance).
- Incorrect dimensioning with regards to the use or faults in the installation or failure to adopt the necessary devices to guarantee proper execution.
- Improper overheating of the equipment, use of fuels not conforming to the types and quantities indicated in the instructions provided.

- Further damage caused by incorrect user interventions in an attempt to fix the initial fault.
- Worsening of the damage due to the continued use of the equipment by the user, once the defect has been noticed.
- In the presence of a boiler, any corrosions, incrustations or breaks caused by water flow, condensation, hardness or acidity of the water, improperly performed descaling treatments, lack of water, mud or limescale deposits.
- Inefficiency of chimneys, flues or parts of the plant affecting the equipment.
- Damage caused by tampering with the appliance, atmospheric agents, natural disasters, vandalism, electrical discharges, fires, faults in the electric and/or hydraulic system.
- Failure to have the stove cleaned on an annual basis by an authorised technician or qualified personnel will result in the loss of the warranty.

Also excluded from this guarantee are:

- Parts subject to normal wear such as gaskets, glass, claddings and cast iron grids, painted, chrome-plated or gilded parts, handles and electric cables, bulbs, indicator lights, knobs, all parts which can be removed from the hearth.
- Variations in colour of the painted or ceramic/serpentine parts and craquelure ceramics as they are natural characteristics of the material and product use.
- Masonry work.
- Plant parts (if present) not supplied by the manufacturer.

Any technical interventions on the product to eliminate the above-said defects and consequent damages must be agreed upon with the Technical Assistance Centre, who reserves the right to accept the relative appointment or not. However, said interventions will not be carried out under warranty but as technical assistance to be granted at part of any eventual and specific agreed conditions and in accordance with the fee in force for the work to be carried out.

The user will also be charged for any costs incurred to remedy the incorrect technical interventions, tampering or damage to the appliance, not attributable to original faults.

Save for the legal or regulatory limits, the guarantee does not cover the containment of atmospheric and acoustic pollution.

The company declines all liability for any damage which may be caused, directly or indirectly, to persons, animals or objects as a consequence of non compliance with any prescription specified in the manual, especially warnings regarding installation, use and maintenance of the appliance.

5.1 PRODUCT PERFORMANCE CHECKS

All our products undergo ITT TESTS carried out by a notified laboratory (system 3) and in accordance with (EU) Regulation number 305/2011 "Construction products", according to standard EN 14785:2006 (pellets) and "Machinery Directive" EN 303-5 (boilers).

In the case of tests for any market surveillance or inspections by third parties, please consider the following warnings:

- to reach the declared performance levels, the product must perform an operating cycle of at least 15/20 hours beforehand
- use the average draught of the combustion smoke specified in the "product technical specifications" table
- the type of pellets used must comply with current EN ISO 17225-2 regulations
- the amount of fuel may vary according to the length and calorific value of the fuel. This may require some adjustments to stay in line with the hourly consumption specified in the "product technical specifications" table. A1 pellets ensure an overall calorific value within tight margins compared to the test pellets used. However, size considerably affects performance, therefore on average it must
- not be less than 24 mm long and with a 6mm diameter
- in the case of a wood-burning product, check the correct residual moisture content of the fuel, which must not be less than 12% or more than 20%. As the moisture increases, different combustion air settings are required. The settings are to be carried out via the combustion air register, thereby modifying the mixture between primary and secondary air
- it is required to check the operation of devices that can affect performance (for example air fans or electrical safety devices) in case of damage due to handling.
- maximum performance can be achieved at the maximum flame and ventilation power.
- strictly comply with the withdrawal points required by regulations both in terms of emissions and temperature.

6 SPARE PARTS

For each repair or adjustment which should be necessary, please contact the dealer where you purchased your stove or your nearest Technical Assistance Service, specifying:

- Appliance model
- Serial number
- Type of problem

Use only original spare parts which you can find at our Technical Assistance Services.

7 WARNINGS FOR THE CORRECT DISPOSAL OF THE PRODUCT

The owner is the sole party responsible for demolishing and disposing of the product. This must be performed in compliance with laws related to safety and environmental protection in force in his/her country.

At the end of its working life, the product must not be disposed of as urban waste. **It must be taken to a special differentiated waste** collection centre set up by the local authorities or to a retailer that provides this service.

Separating and recycling prevents potential negative effects on the environment and health (often caused by inappropriately disposing of product parts). It also allows materials to be recovered in order to obtain significant savings in energy and resources.

7.1 INFORMATION FOR MANAGEMENT OF ELECTRIC AND ELECTRONIC APPLIANCE WASTE CONTAINING BATTERIES OR ACCUMULATORS

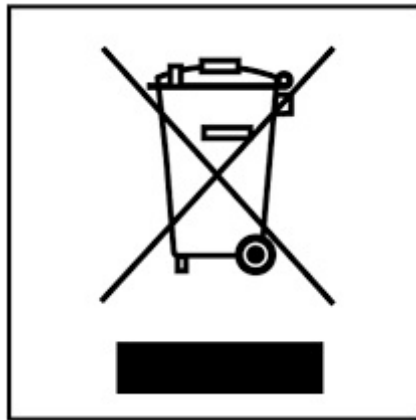

Fig. 1 - Waste disposal

This symbol, which is used on the product, batteries, accumulators or on the packaging or documents, means that at the end of its useful life, this product, the batteries and the accumulators included must not be collected, recycled or disposed of together with domestic waste.

Improper management of electric or electronic waste or batteries or accumulators can lead to the leakage of hazardous substances contained in the product. For the purpose of preventing damage to health or the environment, users are kindly asked to separate this equipment and/or batteries or accumulators included from other types of waste and to arrange for disposal by the municipal waste service. It is possible to ask your local dealer to collect the waste electric or electronic appliance under the conditions and following the methods provided by national laws transposing the Directive 2012/19/EU.

Separate waste collection and recycling of unused electric and electronic equipment, batteries and accumulators helps to save natural resources and to guarantee that this waste is processed in a manner that is safe for health and the environment.

For more information about how to collect electric and electronic equipment and appliances, batteries and accumulators, please contact your local Council or Public Authority competent to issue the relevant permits.

8 WI-FI - BLUETOOTH CONNECTION

8.1 EASY CONNECT PLUS



Procedure if only valid for models with EASY CONNECT PLUS Wi-Fi technology.



Fig. 2 - EASY CONNECT PLUS module



Fig. 3 - App EASY CONNECT PLUS

The documentation for connecting the Wi-Fi and using the App are available online at the following addresses:

| | |
|--|---|
| | https://www.cadelsrl.com/download-wi-fi/ |
| | http://www.free-point.it/it/downloads/ |
| | https://www.pegasoheating.com/it/documenti/ |

8.2 NAVEL STAND ALONE



Procedure if only valid for models with NAVEL STAND ALONE Wi-Fi technology.



ATTENTION! Installation must **ONLY** be carried out by specialised personnel.

The manufacturer will not be held responsible for injury to persons or damage to property or in the event of failed operation.

The Wi-Fi module uses the domestic Wi-Fi network; ensure there is enough coverage in the place of installation.



Fig. 4- NAVEL STAND ALONE module

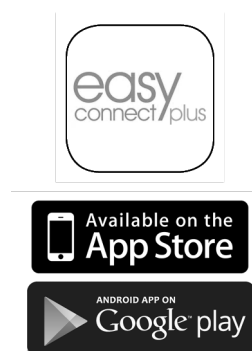





Fig. 5- App EASY CONNECT PLUS

The documentation for connecting the Wi-Fi and using the App are available online at the following addresses:

| | |
|---|---|
|  | https://www.cadelsrl.com/download-wi-fi/ |
|  | http://www.free-point.it/it/downloads/ |
|  | https://www.pegasoheating.com/it/documenti/ |

9 USE

9.1 INTRODUCTION

To have the best performance with the lowest consumption please follow the here described instructions.

- The lighting of the pellets occurs very easily if the installation is correct and if the chimney flue is efficient.
- Switch on the stove at Power 1 for at least 2 hours in order to enable the materials which make up the boiler and the fireplace to adjust the inner springing stress.
- By using the stove the varnish inside the combustion chamber could be subjected to alterations. This occurrence can be attributed to different reasons: an excessive stove overheating, the presence of chemical agents in bad quality pellets, bad chimney draught, etc. Therefore varnish endurance in the combustion chamber cannot be guaranteed.



Oily plant waste and lacquers can cause smells and smoke during the first working hours: it is advisable to ventilate the room because they could be noxious to people and animals.



Set values from 1 to 5 are defined by the manufacturer and they can be changed only by an authorized technician.

9.2 CONTROL PANEL DISPLAY

Menu items.

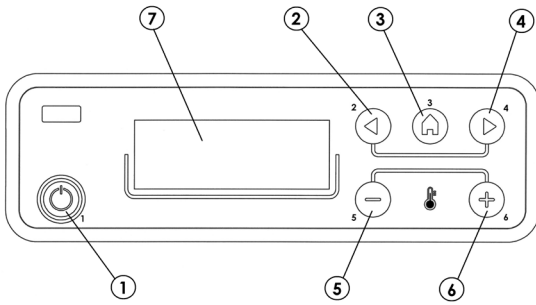

Fig. 6 - Display

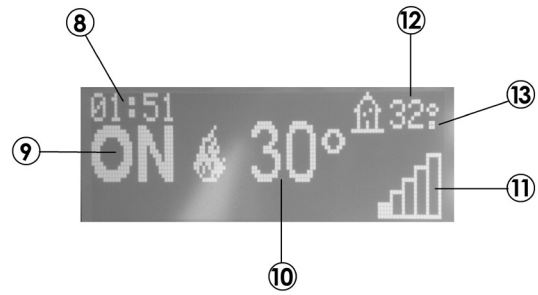

Fig. 7 - Display

| LEGEND | Fig. 2 - Fig. 3 |
|--------|---|
| 1 | Boiler lighting/shutdown (ESC) |
| 2 | Scrolling of programming menu to decrease |
| 3 | Menu |
| 4 | Scrolling of programming menu to increase |
| 5 | Decrease set temperature/programming functions |
| 6 | Increase set temperature/programming functions |
| 7 | Display |
| 8 | Time |
| 9 | Status |
| 10 | Temperature set by user |
| 11 | Instant power |
| 12 | Ambient temperature |
| 13 | If there is $^{\circ} = 0.5^{\circ}\text{C}$ ($29.^{\circ} = 29.5^{\circ}$) |

9.3 MAIN MENU

It is accessed by pressing key 3 (menu). The items that are accessed are:

- Time and Date
- Timer
- Sleep (only with the stove on)
- Settings
- Info

Date and time setting

To set the date and time act as follows:

- Press the "menu" button.
- Select "Time and Date".
- Select by pressing "menu"
- Scroll with the arrows and select the variables to be modified one at a time: Day, Hours, Minutes, Day number, Month, Year.
- Select "menu" to confirm.
- Modify with the + - keys.
- Finally press "menu" to confirm and "esc" to exit.

Timer setting (see relative chapter)

Sleep setting (see relative chapter)

9.4 SETTINGS MENU

The SETTINGS menu allows to act on the boiler operating mode:

- Language.

- B. Cleaning (displayed only when the boiler is switched off).
- C. Feed screw loading (displayed only when the boiler is switched off).
- D. Tones.
- E. External thermostat (activation).
- F. Auto Eco (activation).
- G. Eco-Shutdown T (default 10 minutes).
- H. Pump on T (default 50°C).
- I. Auxiliary boiler (default deactivated).
- J. Pellet recipe.
- K. Smoke rpm % ventilation.
- L. Maximum power (1-5 - default 5).
- M. Components test (displayed only when the boiler is switched off)
- N. "Chimney sweep" function (activated only when the boiler is switched on, for field emissions test).
- O. System configuration.
- P. Season.
- Q. Technical menu.

NOTE: Some of the items listed above cannot be activated in certain "system configurations".

a - Language

To select the language act as follows:

- Press the "menu" button.
- Scroll to "Settings" using the arrows
- Press "menu" to confirm.
- Scroll to "language" using the arrows.
- Press "menu" to confirm.
- With the + - keys select the language of interest (IT/EN/DE/FR/ES/NL/PL/DA)
- Press "menu" to confirm and "esc" to exit.

b - Cleaning

To select "Cleaning" (only when the boiler is switched off) act as follows:

- Press the "menu" button.
- Scroll to "Settings" using the arrows
- Press "menu" to confirm.
- Scroll to "Cleaning" using the arrows.
- Press "menu" to confirm.
- Select "On" with the + - keys.
- Press "menu" to confirm and "esc" to exit.

c - Feed screw loading

Allows to fill the pellets loading system. It can only be activated with the boiler switched off, it displays an 180" countdown after which the feed screw stops automatically, as when exiting the menu.

To select "Feed screw loading" (only when the boiler is switched off) act as follows:

- Press the "menu" button.
- Scroll to "Settings" using the arrows
- Press "menu" to confirm.
- Scroll to "Feed screw loading" using the arrows.
- Press "menu" to confirm.
- Select "Enable" with the + - keys.
- Press "menu" to confirm and "esc" to exit.

d - Tones

This function is disabled by default, so to enable act as follows:

- Press the "menu" button.
- Scroll to "Settings" using the arrows
- Press "menu" to confirm.
- Scroll to "tones" using the arrows.
- Press "menu" to confirm.
- Select "On" with the + - keys.

- Press “menu” to confirm and “esc” to exit.

e - External thermostat (see relative chapter)

EXTERNAL THERMOSTAT (not included with the boiler, it is the user’s responsibility)

The stove can also be temperature-controlled by an external room thermostat. It is positioned centrally with respect to the room where the appliance is installed and ensures greater consistency between the heating temperature requested of the stove and the actual temperature the stove supplies.

Connect the wires from the external thermostat to points 1-2 on the stove terminal board.

Once the thermostat is connected, it must be enabled.

Do so as follows:

- Press the “menu” button.
- Scroll to “Settings” using the arrows.
- Select by pressing “menu”.
- Scroll once again to “External thermostat” using the arrows.
- Select by pressing “menu”.
- Press the - + buttons.
- Select “On” to activate the external thermostat.
- Press the “menu” button to confirm.
- Press the “esc” button to exit.

f - Auto-Eco activation

To select the Auto-Eco function act as follows:

- Press the “menu” button.
- Scroll to “Settings” using the arrows
- Press “menu” to confirm.
- Scroll to “Auto-Eco” using the arrows.
- Press “menu” to confirm.
- Select “On” with the + - keys.
- Press “menu” to confirm and “esc” to exit.

g - Eco Shutdown t

To select the Eco - shutdown t function act as follows:

- Press the “menu” button.
- Scroll to “Settings” using the arrows
- Press “menu” to confirm.
- Scroll to “Eco - shutdown t” using the arrows.
- Press “menu” to confirm.
- Enter the minutes with the + - keys.
- Press “menu” to confirm and “esc” to exit.

h - Pump On T

This menu item allows to adjust the pump activation temperature.

To select the Pump On T function act as follows:

- Press the “menu” button.
- Scroll to “Settings” using the arrows
- Press “menu” to confirm.
- Scroll to “Pump On T” using the arrows.
- Press “menu” to confirm.
- Modify the °C with the + - keys.
- Press “menu” to confirm and “esc” to exit

i - Auxiliary boiler

An additional (optional) module must be installed to allow an auxiliary boiler to be switched on should the stove be off or in alarm conditions. By default, this function is disabled; if necessary, activate it through the settings menu.

j - Pellet Recipe

This function is for adapting the stove to the pellets that are being used. In fact, as there are several types of pellets on the market,

boiler operation is extremely variable depending on the fuel quality. In the event the pellets tend to clog the brazier due to an excessive load of fuel or in the event the flame is always high even at low powers and, vice versa if the flame is low one can decrease/increase the amount of pellets in the brazier:

The available values are:

-3 = Decrease by 30% compared to factory settings.

-2 = Decrease by 20% compared to factory settings.

-1 = Decrease by 10% compared to factory settings.

0 = No variation.

1 = Increase by 5% compared to factory settings.

2 = Increase by 10% compared to factory settings.

3 = Increase by 15% compared to factory settings.

To change the recipe act as follows:

- Press the "menu" button.
- Scroll to "Settings" using the arrows
- Press "menu" to confirm.
- Scroll to "Pellet recipe" using the arrows.
- Press "menu" to confirm.
- Modify the % with the + - keys.
- Press "menu" to confirm and "esc" to exit

k - Smoke rpm % ventilation

If the installation presents difficulties for smoke evacuation (no draught or no pressure in the duct), the smoke and ash expulsion speed can be increased. This change resolves all the potential problems related to pellets clogging in the brazier and deposits forming at the bottom of the brazier itself caused by poor quality fuel or fuel that produces a lot of ashes. The values available are from -30% to +50% with variations of 10 percentage points at a time. The variation in negative can be used in case the flame is too low.

To change the parameter act as follows:

- Press the "menu" button.
- Scroll to "Settings" using the arrows
- Press "menu" to confirm.
- Scroll to "Smoke rpm variation" using the arrows.
- Press "menu" to confirm.
- Modify the % with the + - keys.
- Press "menu" to confirm and "esc" to exit

l - Maximum power

It allows to set the maximum flame limit at which the boiler can operate to reach the set temperature target.

To change the power act as follows:

- Press the "menu" button.
- Scroll to "Settings" using the arrows
- Press "menu" to confirm.
- Scroll to "Maximum power" using the arrows.
- Press "menu" to confirm.
- Change the power from 01 to 05 with the + - keys
- Press "menu" to confirm and "esc" to exit

m - Components test

It can only be carried out with the boiler switched off, it allows to select the components to be tested:

- **Spark plug:** it is turned on for a fixed time of 1 minute during which the panel displays the countdown seconds.
- **Feed screw:** it is powered for a fixed time of 1 minute during which the panel displays the countdown seconds.
- **Extractor:** it is activated at 2500 rpm for a fixed time of 1 minute during which the panel displays the countdown seconds.
- **Exchanger:** it allows to carry out the test in V5 for a fixed time of 1 minute during which the panel displays the countdown seconds.
- **Pump:** it is activated for a fixed time of 10 seconds during which the panel displays the countdown.
- **3 way:** the 3 way valve is activated for a fixed time of 1 minute during which the panel displays the countdown seconds.

To activate the "Components test" function (only when the boiler is switched off) act as follows:

- Press the "menu" button.

- Scroll to "Settings" using the arrows
- Press "menu" to confirm.
- Scroll to "Components test" using the arrows.
- Press "menu" to confirm.
- Select the test to be performed with the + - keys
- Press "menu" to confirm and "esc" to exit

n - Chimney sweep function

This function can be activated only when the boiler is on and with power output and heating operation power with parameters P5, with fan (if present) in V5. Any loading/smoke ventilation percentage corrections must be taken into account. This status lasts 20 minutes, the countdown is displayed on the panel. During this interval the thermostat/puffer/room set point/H2O set point are not taken into account, only the safety shutdown at 85°C remains active. At any time the technician can interrupt this stage by quickly pressing the on/off key.

To activate the "Chimney sweep" function act as follows:

- Press the "menu" button.
- Scroll to "Settings" using the arrows
- Press "menu" to confirm.
- Scroll to the "Chimney sweep" function using the arrows.
- Press "menu" to confirm.
- Select "On" with the + - keys (Off by default)
- Press "menu" to confirm and "esc" to exit

o - System configuration

To change the system configuration act as follows:

- Press the "menu" button.
- Scroll to "Settings" using the arrows
- Press "menu" to confirm.
- Scroll to "System configuration" using the arrows.
- Press "menu" to confirm.
- Change the configuration from 01 to 05 with the + - keys
- Press "menu" to confirm and "esc" to exit.

p - Season

In configurations 2 and 3, by enabling the "summer" function, the deviation of the 3-way valve to the heating system is inhibited in order to prevent the radiators from heating up, therefore the flow is always directed towards the domestic hot water (DHW) - if envisaged.

By activating the "summer" option one automatically enables the auto-eco function (it cannot be deactivated). The room probe/external thermostat are not taken into account.

To change the function act as follows:

- Press the "menu" button.
- Scroll to "Settings" using the arrows
- Press "menu" to confirm.
- Scroll to "Season" using the arrows.
- Press "menu" to confirm.
- Select "Summer" or "Winter" with the + - keys.
- Press "menu" to confirm and "esc" to exit.

q - Technical menu

To access the technical menu one must contact an assistance centre as one needs a password to enter.

To intervene on the "technical menu" act as follows:

- Press the "menu" button.
- Scroll to "Settings" using the arrows
- Press "menu" to confirm.
- Scroll to "Technical menu" using the arrows.
- Press "menu" to confirm.
- Select "Product Type", "Service", "Parameters", "DHW Parameters", "Meters memories", "Enable fan" and "Puffer data" with the + - keys.
- Press "menu" to confirm and "esc" to exit

9.5 AUTO ECO MODE (SEE SECTION F-G)

To activate the “Auto Eco” mode and adjust the time refer see **section f-g**.

The possibility to adjust the “ECO shutdown t” comes from the need to ensure proper operation in the various rooms the boiler can be installed in and prevent continuous shutdowns and start-ups in the event the temperature is subject to sudden changes (air currents, poorly insulated rooms, etc.).

The **ECO** shutdown procedure is activated automatically when all the power demand devices involved in the “system configuration” are satisfied: room probe/external thermostat, flow switch, puffer thermostat/ntc (10 kΩ B3435) or boiler thermostat/ntc (10 kΩ B3435). If all devices present are satisfied the “ECO shutdown t” time decrease starts (by default 10 minutes, it can be changed within the “Settings menu”). During this stage the panel displays **ON** with a small flame and alternately Chrono (of active) - Eco active. The minutes indicating the countdown for the Eco Stop are shown at the top of the display. The flame goes into **P1** and stays there until the programmed “Eco shutdown t” time has elapsed and if the conditions are still satisfied, it goes into the shutdown stage. The ECO switch off countdown resets if one of the devices boosts power again.

When switch off starts the panel displays: **Off - Eco Active** - small flashing flame.

Once the boiler has reached the off condition, the panel displays **OFF-ECO** with the extinguished flame symbol.

To restart from ECO the following conditions must be satisfied simultaneously:

- Power demand
- After 5 minutes from the beginning of shutdown.
- TH20 < TSetH20.
- If the domestic hot water (**DHW**) demands power - if envisaged - the first 5' are ignored and the boiler restarts as needed.

NOTE: In configuration 4 - 5 the Auto Eco mode is enabled automatically. Even when one sets the “summer” function in configuration 2 - 3 it is enabled automatically. In the cases where it is designed to be active, it is not possible to deactivate the mode.

9.6 PROGRAMMED MODE (TIMER) - MAIN MENU



Setting the current day and time is essential for the proper operation of the timer.

There are six **TIMER** programmes, for each one the user can decide the start-up and shutdown time as well as the day of the week in which it is active.

When one or more programmes are active, the panel alternately displays the boiler status and **TIMER “n”** whereby “n” is the number relating to the activated timer programmes, separated from each other with a dash

Example:

- **TIMER 1** Timer programme 1 active.
- **TIMER 1-4** Timer programmes 1 and 4 active.
- **TIMER 1-2-3-4-5-6** Timer programmes all active.

EXAMPLE OF PROGRAMMING

With boiler on or off:

- access the **MENU**,
- scroll to **TIMER** with the <> arrows,
- press the “Menu” key
- the system proposes “P1” (Press the <> keys for the subsequent timers P2,P3, P4, P5, P6)
- to activate “P1” press the “Menu” key
- press + - and select “ON”
- confirm with the “Menu” key

At this point it will propose 00:00 as starting time, with key + - adjust the starting time and press the “menu” key to confirm.

The next step proposes a shutdown time of 10 minutes above that set for start-up: press the + key and adjust the shutdown time, confirm with the “menu” key.

Subsequently the system proposes the days of the week in which to activate or deactivate the previously set timer. With the - or + key highlight with the white background the day in which one wishes to activate the timer and confirm with the “menu” key. If no day of the week is confirmed as active, in turn the timer programme will not appear active in the status screen.

Continue to program the following days or press “ESC” to exit. Repeat the procedure to program the other timers.

| P1 | | | P2 | | |
|--|-------|-----|-------|-------|-----|
| on | off | day | on | off | day |
| 08:00 | 12:00 | mon | 11:00 | 14:00 | mon |
| Boiler on from 08:00 to 14:00 | | | | | |
| | | | | | |
| on | off | day | on | off | day |
| 08:00 | 11:00 | mon | 11:00 | 14:00 | mon |
| Boiler on from 08:00 to 14:00 | | | | | |
| | | | | | |
| on | off | day | on | off | day |
| 17:00 | 24:00 | mon | 00:00 | 06:00 | tue |
| Boiler on from 17:00 on monday to 06:00 on tuesday | | | | | |

9.7 NOTES FOR TIMER OPERATION

- Start-up with the timer always takes place with the last temperature and ventilation settings (or with default 20°C and V3 settings in the event they have never been changed).
- Start-up time ranges from 00:00 a 23:50
- If the shutdown time is not already memorised, it proposes a start-up time in + 10 minutes.
- A timer programme switches the boiler off at 24:00 of one day and another programme switches it on at 00:00 of the next day: the boiler stays on.
- A programme proposes a start-up and shutdown in times included within another timer programme: if the boiler is already on, start will not have any effect, while OFF will switch it off.
- In the boiler on and timer active condition, press the OFF key and the boiler will switch off, it will switch on automatically at the next time set on the timer.
- In the boiler off and timer active condition, press the ON key and the boiler will switch on, it will switch off at the time set on the active timer.

9.8 SLEEP FUNCTION (MAIN MENU)

The sleep function is activated only when the boiler is switched on and allows to quickly set a time at which the product must switch off. To set the Sleep function act as follows:

- Enter MENU
- Scroll to SLEEP with the <> arrows
- Press Menu
- With the + - keys adjust the desired shutdown time.

The panel proposes a shutdown time of 10 minutes from the current time, adjustable with key 4 until the next day (I can therefore delay the shutdown for up to a maximum of 23 hours and 50 minutes).

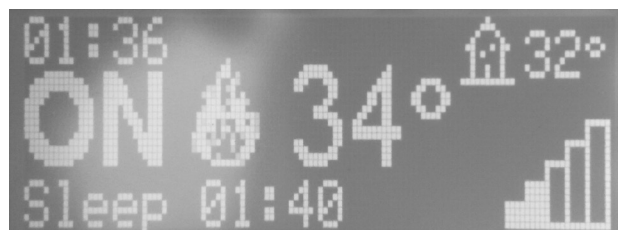

Fig. 8 - Sleep

If the SLEEP function is active with the TIMER active the first has priority over the latter, therefore the boiler will not switch off at the time set on the timer but instead by the time established by the sleep function, even if later than the time set on the timer.

10 FIRST IGNITION WARNINGS

10.1 START UP

We remind you that the first ignition must be carried out by a specialized and authorized technician who will check that all is installed in compliance with current regulations and checks the efficiency.

- If inside the combustion chamber there are booklets, manuals, etc..., remove them.
- Check if the door is correctly closed.
- Check if the stove is correctly inserted in the electric socket.
- Before switching the stove on, assure you the burning pot is clean.
- To start the stove, keep the P1 button pressed until the ON sign and a flashing flame to its side appear. The ignition resistance pre-heating starts. After some seconds the feed screw loads pellets and the resistance pre-heating continues. When the temperature is high enough (after about 5-8 minutes), ignition is considered to be completed.

10.2 GENERAL WARNINGS

Remove all components that could burn (manual, various adhesive labels, and any polystyrene) from the product brazier and glass. **Make sure the brazier is positioned properly and rests solidly on the base.**



The first ignition may fail, given that the feed screw is empty and is not always able to load the brazier in time with the amount of pellets needed to ignite the flame.



CLEAR THE FAILED IGNITION ALARM CONDITION. REMOVE THE PELLETS IN THE BRAZIER AND REPEAT IGNITION.

If after several failed ignitions, there is still no flame even with normal pellet supply, make sure the brazier is positioned properly, resting snugly in its housing without any ash build-up. If everything is as it should be, this means there might be a problem with the product components or caused by improper installation.



REMOVE THE PELLETS FROM THE BRAZIER AND REQUEST ASSISTANCE FROM AN AUTHORISED TECHNICIAN.



It is a good idea to ensure efficient ventilation in the room during the initial ignition, as the stove will give off some smoke and the smell of paint.



ATTENTION!
Make sure pellets and ash have not accumulated in the brazier due to failed ignition. If the brazier is not cleaned before reattempting, there is the risk of further failed ignitions and even explosions in some cases.

Keep away from the stove and, as previously mentioned, air out the room. The smoke and the smell of paint will dissipate after about an hour of operation; in any case, remember that they are not harmful to health. The stove is subjected to expansion and contraction during the ignition and cooling phases; as such, it may make slight creaking sounds. This is absolutely normal, as the structure is built in laminated steel, and is not to be considered a defect. It is extremely important to make sure not to overheat the stove right away, but rather heat it gradually to the desired temperature, initially using low power. This will prevent damage to the ceramic plates or coil, welding, and steel structure.



DO NOT IMMEDIATELY EXPECT HEATING EFFICIENCY!!!

ATTENTION!

If smoke flows into the room from the appliance or the flue during operation or initial ignition, switch off the device, air out the room, and immediately contact the installation/customer service technician.

10.3 POWER OUTPUT

Once the start-up stage is complete the control panel will display ON with a fixed flame at level 3. The subsequent flame modulation at lower or higher powers is managed autonomously and upon reaching the temperatures set in the "System configuration".

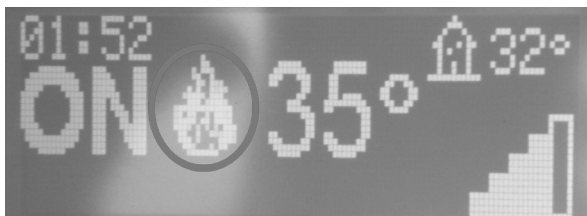

Fig. 9 - big Flame

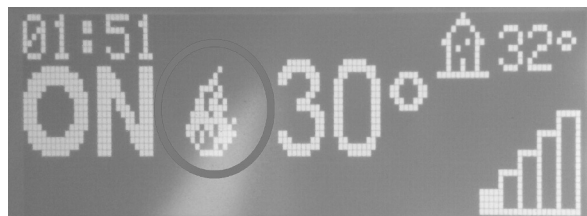

Fig. 10 - small Flame

10.4 ADJUSTMENTS MENU

To access the adjustments menu act as follows:

- Press the + - keys
- Scroll with the <> arrows and select "Set Room T" or "Set Water T" or "Exchanger Speed"
- Press "menu" to access the selected option.
- Modify with the + - keys.
- Press "menu" to confirm and "esc" to exit.

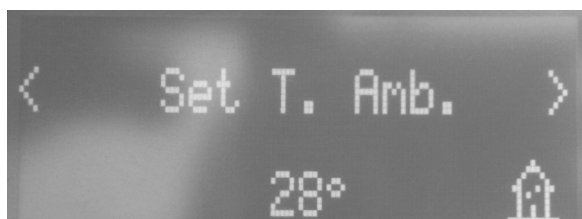

Fig. 11 - Display

Note: The full stop to the right of the ambient temperature shown in the control panel display (upper right) indicates the half degree (e.g. 23.° means 23.5°C).

Air V. Speed - this function allows selecting the desired speed for the ambient fans from 1 to 5 or A. A means automatic, ventilation depends on power, recommended setting (see Fig. 7).

10.5 NORMAL SHUTDOWN (ON THE PANEL: OFF WITH FLASHING FLAME)

If the shutdown key is pressed or if there is an alarm signal, the boiler goes into the thermal shutdown phase which entails the automatic execution of the following stages:

- It stops pellets loading
- The room fan (if provided) maintains the set speed until the smoke T reaches 100°C, then it automatically sets itself at the minimum speed until it reaches the shutdown temperature
- The smoke fan sets itself at maximum speed and maintains it for a fixed time of 10 minutes, at the end of which if the smoke

T has fallen below the shutdown threshold it switches off permanently, otherwise it sets itself at the minimum speed until it reaches such threshold before switching off.

- If the boiler was shutdown regularly but, due to thermal inertia the smoke temperature exceeds the threshold again, the shutdown stage restarts at the minimum speed until the temperature goes down.

10.6 POWER FAILURE

- After a black-out lower than 10 seconds, the stove turns back to the power which was settled.
- After a black-out of more than 10 seconds, the stove enters the during shutdown. Completed this phase, it starts automatically up with the different phases.

10.7 FAILED IGNITION

If pellets should not ignite, the lack of ignition will be signalled by the A01 "No Ignition" warning.

If the ambient temperature is below 5°C, the resistance may not heat up enough to guarantee the pellet ignition. In this case, remove the unburned pellets from the burning pot and restart ignition.

- Too much pellets in the burning pot, or humid pellet, or sooty burning pot make ignition difficult and create dense white smoke which is harmful to health and can cause explosions on the combustion chamber. It is therefore necessary not to stand in front of the stove during ignition stage if dense white smoke is present.



If after some months the flame appears weak and/or orange colored or the glass tends to blackens and the burning pot to become encrusted, clean the stove, clean the fume conduit and the chimney flue.

11 RECOMMENDATIONS FOR SAFE USE



ONLY PROPER INSTALLATION AND APPROPRIATELY SERVICING AND CLEANING THE APPLIANCE CAN ENSURE PROPER OPERATION AND SAFE PRODUCT USE

We wish to inform you that we are aware of cases of malfunctioning domestic pellet heating products, essentially due to improper installations and inappropriate maintenance.

We wish to ensure you that all our products are extremely safe and certified according to the European reference standards. The ignition system was tested with extreme care to increase ignition efficiency and prevent any issues even in the worst operating conditions. In any case, as with any pellet product, our appliances must be installed properly and periodically cleaned and serviced in order to ensure safe operation. Our research suggests that these malfunctions are essentially due to a combination of part or all of the following factors:

- Clogged brazier holes or deformed brazier, due to poor maintenance. These conditions can cause delayed ignition, creating an abnormal production of unburnt gases.
- Insufficient combustion air due to a reduced or clogged air intake duct.
- Using smoke ducts that do not meet the installation standard requirements, such to fail to ensure appropriate draft.
- Partially obstructed chimney due to poor maintenance, such to reduce draft, making ignition difficult.
- Terminal chimney cap not compliant with the instructions manual, thus not suitable to prevent potential backdraft.
- This factor becomes crucial when the product is installed in particularly windy areas, like on the coast.

The combination of one or more of these factors could cause significant malfunctions.

To prevent this from happening, it is essential to ensure the product is installed in compliance with the standards in force.

Furthermore, it is essential to follow these simple rules:

- Every time it is removed for cleaning, the brazier must always be properly repositioned in the work position before using the product, thoroughly cleaning any residual dirt on the support base.
- Never load pellets into the brazier manually, either before ignition or during operation.
- Any unburnt pellets after a failed ignition must be removed before re-igniting the product. Also make sure it is properly positioned in its housing and check for normal combustion air intake/smoke extraction.
- If the product repeatedly fails to ignite, we recommend that you stop using it immediately and contact a qualified technician to check product operation.

Following these instructions is more than enough to ensure normal operation and prevent any issues with the product.

If the above precautions are not respected and there is a pellet overload in the brazier during ignition and subsequent abnormal smoke generated in the combustion chamber, carefully follow these instructions:

- Do not, for any reason, unplug the product from the electrical mains: this would stop the smoke extraction fan, resulting in smoke being emitted into the room.
- Pre-emptively open the windows to air any smoke out of the installation room (the chimney may not work normally)
- Do not open the fire door, as this would compromise normal operation of the smoke exhaust system to the chimney.
- Simply switch off the stove using the on/off button on the control panel (not the rear button of the power supply plug!) and move away from the product as you wait for the smoke to clear completely.
- Before any attempts to reignite the product, thoroughly clean the brazier and its air passage holes from build-up and any unburnt pellets; reposition the brazier in its housing, removing any residue from its support base. If the product repeatedly fails to ignite, we recommend that you stop using it immediately and contact a qualified technician to check product and chimney operation.

12 FUEL

12.1 FUEL

- Use top-quality pellets because they have influence in the calorific value and in ash remains.
- Pellets features are: dimension $\varnothing 6-7$ mm (D06 Class), maximum length 40 mm, calorific value 5kWh/kg, humidity $\leq 10\%$, ash remains $\leq 0,7\%$, they must be correctly pressed and not much mealy, without sizing agents, resins and other additives (class A1 pellets according to ISO 17225-2 (type ENplus-A1) are recommended).
- Not adequate pellets cause a bad combustion, a frequent burning pot obstruction and exhaust conduits obstruction. Further it decreases the calorific value, soils the glass and increases consumptions and ash and unburnt granules quantity.



Humid pellets cause a bad combustion and running, so please assure you that they are stored in dry places and far at least one meter from the stove and/or any other source of heat.

- It is advisable to try different type of pellets available on the market and to choose that which gives the best performance.
- The use of bad quality pellets can damage the stove so that the warranty and manufacturer liability fall.
- Pellets of variable quality and size are available on the market: the smaller the pellet, the greater the fuel supply, resulting in poor combustion



Depending on the type of pellets it could be necessary a parameters adjustment, please contact an Authorized Assistance Service.

12.2 PELLET SUPPLY



Fig. 12 - Wrong opening of the pellets bag



Fig. 13 - Right opening of the pellets bag

It is necessary to avoid to fill the hopper with the pellet when the stove is running.

- Do not get the bag of pellet in contact with hot stove surfaces.

- Do not empty the hopper with remaining fuels (unburnt pellet) from the burning pot coming from ignition waster.

12.3 LOADING THE PELLETS

The fuel is loaded through the side or front hatch to be mounted onto the cladding, which allows access to the fuel loading chute. The loading procedure is facilitated if performed in a number of steps as described below:

- Open the hatch and pour onto the chute half the content directly from the sack or using the supplied scoop (A)
- Complete the operation by pouring the second half of the sack with the same procedure



**No other type of fuel other than pellets needs to be inserted into the hopper, in compliance with the afore-mentioned specifications.
Store the spare fuel at an adequately safe distance.
Do not load pellets directly onto the brazier, but only into the hopper via the loading system.**

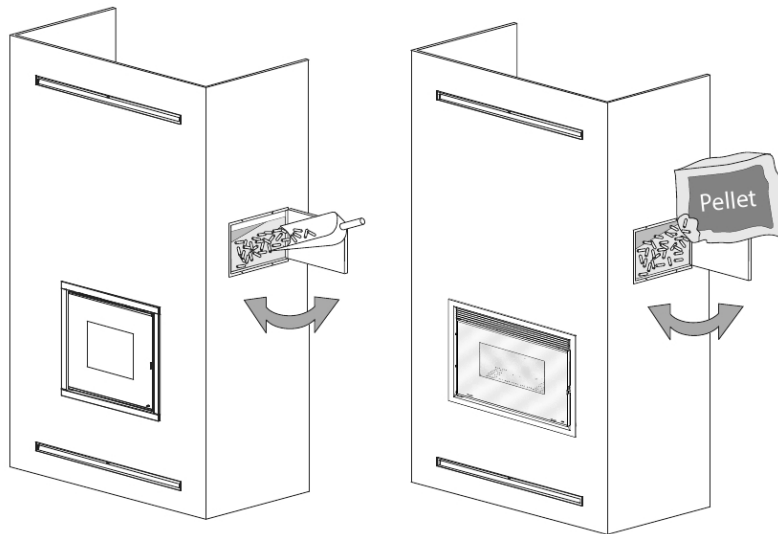

Fig. 14 - LOADING PELLETS

12.4 USER TRAINING

The technician in charge of installation and commissioning MUST ALWAYS thoroughly brief the end owner/user on the device. The following subjects must be covered in detail so that the end user is satisfied. Otherwise, there is the risk the device will be used unsafely:

- Explanation of the device and how it works
- Need to keep the device ventilated and issues that could arise otherwise
- Fuel use and supply
- How to safely ignite the device
- What to do if it does not ignite
- What to do in the event of alarms (in particular, those generated by a lack of fuel in the device)
- How to service the device properly and the importance of doing so monthly
- It is a good idea to schedule the first annual service check
- Discuss using a potential secondary heating system
- Explain how the remote control or thermostat works and where to best position them

13

14 SAFETY DEVICES AND ALARMS

14.1 SAFETY DEVICES

The product is supplied with the following safety devices

14.2 PRESSURE SWITCH

- It controls pressure in the fume duct. It blocks the pellet feed screw in the following instances:
 - - clogged exhaust
 - - Significant negative (wind)
 - - clogged fume passages
 - - open pellet loading tank
 - - open fire door or worn/broken gaskets.

14.3 SMOKE TEMPERATURE PROBE

Detects the temperature of the smoke, thereby enabling start-up or stopping the product when the temperature drops below the preset value.

14.4 CONTACT THERMOSTAT IN THE FUEL HOPPER

If the temperature exceeds the preset safety level, it immediately shuts down boiler operation.

14.5 ELECTRICAL SAFETY

The product is protected against sudden current surges by a main fuse in the power supply panel on the rear part of the product. Other fuses that protect the electronic boards are found on the latter.

14.6 SMOKE FAN

If the fan stops, the electronic board promptly shuts off the pellets supply and an alarm message is displayed.

14.7 GEAR MOTOR

If the gear motor stops, the boiler will continue to run until the flame goes out due to lack of fuel and until a minimum level of cooling is reached.

14.8 TEMPORARY POWER CUT

If the power cut lasts less than 10" the boiler returns to its previous operating status; if it lasts more it carries out a cooling/restart cycle.

14.9 FAILED START-UP

If during ignition no flame develops, the boiler will go into alarm condition.

14.10 BLACKOUT WITH THE BOILER ON

In the event of a power cut (**blAc-out**) the boiler behaves as follows:

- Blackout below 5": it returns to its operation in progress;
- In the event of a power cut that lasts over 10" with the boiler on or in the start-up stage, when the boiler is powered again it goes back to the previous operating condition with the following procedure:
 - 18) It performs a cooling phase to the maximum.
 - 19) Performs a new ignition.

During stage 1 the panel displays ON BLACK OUT.

During stage 2 the panel displays Start-up.

If during stage 1 the boiler receives commands from the panel and thus carried out manually by the user, then the boiler stops executing the blackout recovery status and proceeds to restart or shutdown as requested by the command.

14.11 BLACKOUT OF MORE THAN 10" DURING STOVE SHUTDOWN

If the stove experiences a loss of power LONGER THAN 10" while it is shutting down, when power is restored to the stove, it will automatically turn on in shutdown mode, even if the smoke temperature has fallen below 45°C in the meantime. This last stage can be skipped by pressing key 1 (esc) (skips to start-up) and pressing it again (recognises that the stove is off).

14.12 CONTACT THERMOSTAT IN THE BOILER

If the temperature exceeds the preset safety level, it immediately shuts down boiler operation.

14.13 WATER TEMPERATURE PROBE

If the water temperature approaches the shutdown temperature (85°C) the probe makes the boiler perform the "OFF Stand-by" automatic shutdown.

14.14 ANTIFREEZE FUNCTION

If the probe in the boiler detects a water temperature of less than 5°C, the circulation pump is automatically activated to prevent the system from freezing.

14.15 PUMP ANTI-SEIZURE FUNCTION

If the pump is not used for prolonged periods, it is activated periodically for a few seconds to prevent it from seizing up.



TAMPERING WITH THE SAFETY DEVICES IS PROHIBITED

If the product is NOT used as described in this instruction manual, the manufacturer declines all liability for any damage caused to persons and property. The manufacturer furthermore refuses to accept responsibility for damage to persons and property arising from the failure to observe all the rules contained in the manual and in particular:

- All the necessary measures and/or precautions must be adopted when performing maintenance, cleaning and repairs.*
- Do not tamper with the safety devices.*
- Do not remove the safety devices.*
- Connect the product to an efficient smoke expulsion system.*
- Verify that the room in which the appliance will be installed is adequately ventilated.*

The product can be started-up and the automatic function of the probe restored only after having eliminated the cause that triggered the safety system. This manual will help you understand which anomaly has occurred, and explain how to intervene according to the alarm message displayed on the appliance.

14.16 ALARM ALERTS

Whenever an operating condition other than that designed for the regular operation of the boiler occurs, there is an alarm condition. The control panel gives information on the reason of the alarm in progress. A sound signal is not envisioned for alarms A01-A02 only so to PANEL ALERT not disturb the user in the event of pellets running out in the hopper during the night.

| PANEL ALERT | TYPE OF PROBLEM | SOLUTION |
|-----------------------------|--|--|
| A01 | The fire does not ignite. | Check whether the brazier is clean / level of pellets in the hopper. |
| A02 | The fire goes off abnormally. | Check the level of pellets in the hopper. |
| A03 Thermostat alarms | The temperature of the pellets hopper or the water temperature exceed the envisioned safety threshold. | Wait for the cooling stage to end, cancel the alarm and restart the boiler setting the fuel loading at minimum (SETTINGS menu - Pellets recipe). If the alarm persists, contact the service centre. Check if the room fan works properly (if present). |
| A04 | Smoke overheating. | The set smoke threshold has been exceeded. Reduce pellets loading (SETTINGS menu - Pellets recipe). |
| A05 Pressure switches alarm | Smoke pressure switch intervention or water pressure insufficient. | Verify chimney obstruction / door opening or hydraulic system pressure. |
| A08 | Abnormal smoke fan operation. | If the alarm persists, contact the service centre. |
| A09 | Smoke probe faulty. | If the alarm persists, contact the service centre. |
| A19 | Water probe faulty. | Water probe disconnected / interrupted / defective / not recognised. |
| A20 | Puffer probe alarm. | Puffer probe disconnected / interrupted / defective / not recognised. |
| A21 | Triac alarm | The triac of the electronic card has stalled. Replace the card. |
| SERVICE | Routine maintenance alert (it does not block the system). | When this flashing message appears upon start-up, it means that the preset operating hours have elapsed before maintenance. Contact the service centre. |

14.17 ALARM RESET



NEVER open the stove door while it is starting up initially or switching off, as the pellets are still burning at this point and there may be volatile substances.

ATTENTION!

If smoke flows into the room from the appliance or the flue during operation or initial ignition, switch off the device, air out the room, and immediately contact the installation/customer service technician.

To reset the alarm, you must hold down key 1 (ESC) for a few seconds. The stove performs a check to determine whether what caused the alarm is still present.

If this is the case, the alarm will be shown again, otherwise the stove will switch OFF.

If the alarm persists, contact a service centre.

15 ROUTINE MAINTENANCE

15.1 INTRODUCTION

For a long working life of the stove, have a periodic cleaning of the stove as described in the following paragraphs.

- Fume outlet pipes (fume conduit + chimney flue + chimney pot) must always be cleaned, scrubbed and checked by an authorized technician in compliance with local regulations, with the instructions of the manufacturer and those of your insurance company.
- If there are no local regulations and no instruction from your insurance company, it is necessary to have your fume pipe, chimney flue and chimney pot cleaned at least once a year.
- It is also necessary to have the combustion chamber, motors and fans cleaned and to have the gaskets and the electrical elements checked at least once a year.



All these operations must be planned in time with your Authorized Technical Assistance Service.

- After a long ineffective time, before turning on the stove check if there are obstructions in the fume exhaust.
- If the stove had been using continuously and intensely, the whole system (chimney included), must be cleaned and checked more frequently.
- In case of replacement of damaged pieces please ask for the original spare part at the Authorized Retailer.

15.2 BEFORE EACH START-UP

Clean the ash and any deposits in the brazier that could clog the air passage holes.

If the pellets in the hopper finish, unburned pellets may accumulate in the brazier. Always empty the residue in the brazier before starting up. Check that there is no excessive ash accumulated under the burning pot compartment. If it exceeds 2 cm of height, we recommend sucking it.



REMEMBER THAT ONLY A CORRECTLY POSITIONED AND CLEAN BRAZIER CAN GUARANTEE START-UP AND OPTIMAL OPERATION OF YOUR PELLET PRODUCT.

For the brazier to be cleaned properly, remove it from its housing completely and thoroughly clean all the holes and the grate on the bottom. If good quality pellets are used, you will normally only need to use a brush to restore the optimal operating conditions of the component.

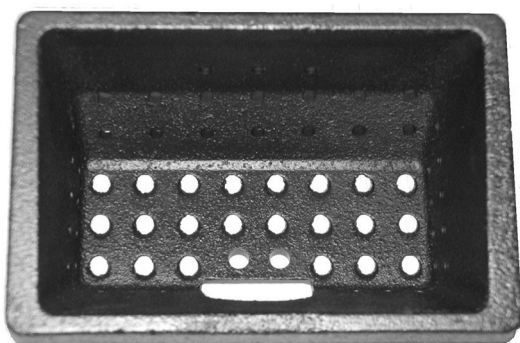

Fig. 15 - Example of cleanly brazier

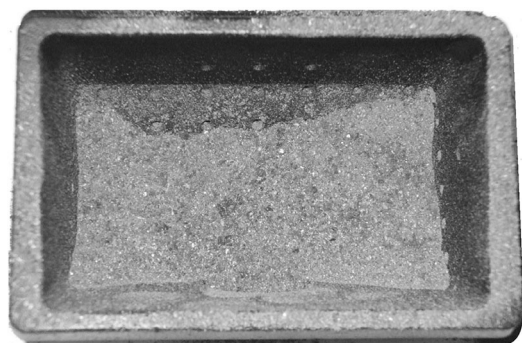

Fig. 16 - Example of dirty brazier

15.3 HOPPER CLEANING

Per each pellets supply, check the probable presence of meal, sawdust and other remainins on the hopper bottom. If present, they must be removed with the aid of a vacuum cleaner (see **Fig. 13**).



Fig. 17 - Hopper cleaning

15.4 DAILY OR WEEKLY CLEANING PERFORMED BY THE USER

BRAZIER CLEANING

Before ignition, always clean the brazier "b" and remove any ash or incrustation from it that might obstruct the air flow holes, paying attention to hot ash. In the case of ignition failure, or if fuel in the hopper runs out, unburned pellets may accumulate in the brazier. Always empty the residue in the brazier before each ignition. **Only if ash is completely cold** may a vacuum cleaner be used to remove it. In this case, use a suitable vacuum cleaner to remove small sized particles.

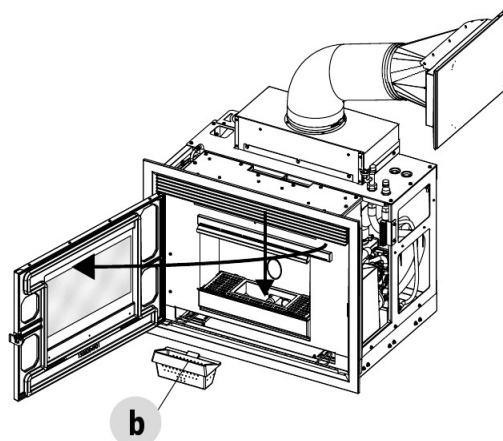

Fig. 18 - Brazier Cleaning



REMEMBER THAT ONLY A CORRECTLY POSITIONED AND CLEAN BRAZIER CAN GUARANTEE IGNITION AND OPTIMAL OPERATION OF YOUR PELLET PRODUCT. IN CASE OF FAILED IGNITION AND AFTER ANY OTHER LOCK STATE OF THE PRODUCT, IT IS ESSENTIAL TO EMPTY THE BRAZIER BEFORE EVERY RESTART.

For the brazier to be cleaned properly, remove it from its housing completely and thoroughly clean all the holes and the grate on the bottom. If high quality pellets are used, you will normally only need to use a brush to restore the optimal operating conditions of the component.

CLEANING THE ASH COLLECTION COMPARTMENT

To clean the ash collection compartment, extract the ash pan "P". Remove any residual ash before reinserting the pan. Your experience and the quality of the pellets will determine how often the ash pan must be cleaned.

However, it is recommended not to exceed 2 or 3 days.

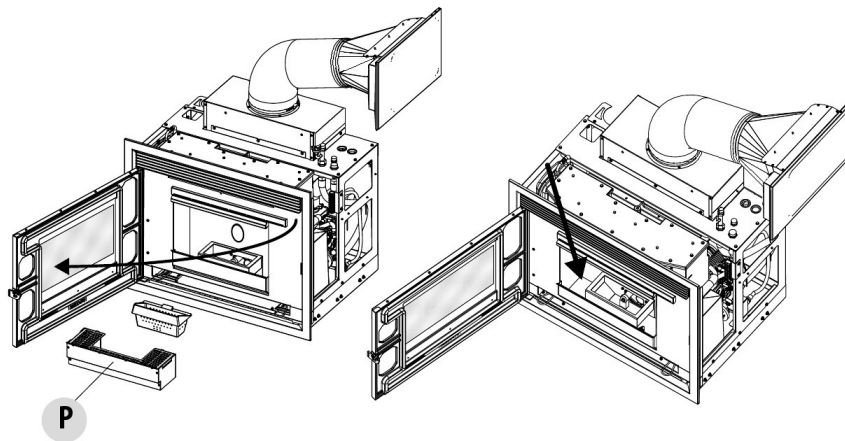

Fig. 19 - Ash drawer

Attention! Once cleaning is completed, remember to put the ash pan “P” back in, insert the brazier “b” and close the firebox door.

15.5 CLEANING THE GLASS

It is recommended to clean the ceramic glass with a dry brush, or if it is very dirty, spray a little specific detergent and clean with a cloth.



ATTENTION!

Do not use abrasive products and do not spray the glass spray cleaner on the painted parts or the door gaskets (ceramic fibre cord).

15.6 CLEAN THE EXCHANGER AND THE COMPARTMENT BENEATH THE BRAZIER

- **Clean the pipe unit** - Using the two “A” hooks supplied, placed in the lower part of the brazier, vigorously shake the “T” turbulators 5-6 times. This will remove any soot that has deposited in the exchanger’s smoke ducts during normal stove operation.
- When this operation is over, clean the ash pan again.

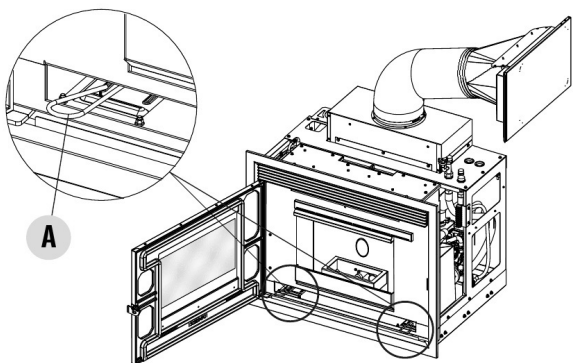

Fig. 20 - Cleaning 1

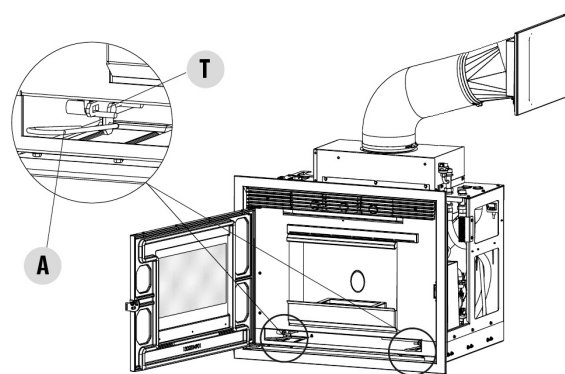

Fig. 21 - Cleaning 2

15.7 PIPE UNIT CLEANING

For improved boiler performance, once a month it is necessary to clean the pipes inside the combustion chamber. Open the firebox door and use the supplied brush to clean the 5 pipes located at the top inside the combustion chamber. Do this several times so that the ash deposited inside these pipes falls into the lower area around the brazier. Use a vacuum cleaner to remove all the fallen material.

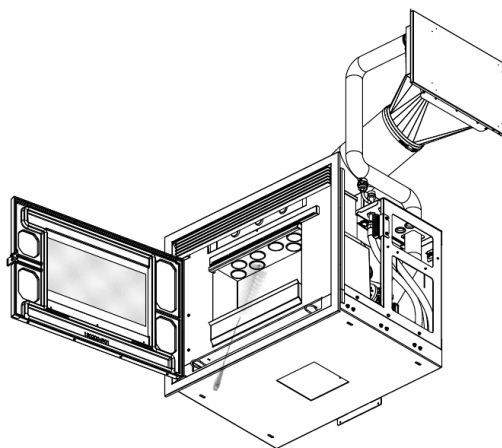

Fig. 22 - Pipe unit cleaning

15.8 FUME PIPES ANNUAL CLEANING

Clean annually from soot with brushes.

The cleaning operation must be executed by a specialized stove-repairer who will provide for the cleaning of fume pipe, chimney flue and chimney pot. He will also check their efficiency and will release a written declaration of the safety of the appliance. This operation must be executed at least once a year.

15.9 GENERAL CLEANING

For cleaning external and inner parts of the stove do not use steel wools, muriatic acid or other corrosive and abrasive materials.

15.10 CLEANING OF PAINTED METAL PANELS

To clean painted metal panels use a soft cloth. Do not use degreasant agents like alcohol, diluents, acetone, gasoline because these could irremediably damage the varnish.

15.11 CLEANING OF CERAMIC AND STONE PANELS

Some stove models has an external lining made up of ceramic or stone. These pieces are handmade therefore they could inevitably present crazings, seedinesses, shadings.

To clean ceramic or stone panels use a soft and dry cloth. If using any cleaners this will seep through the crazings putting them in evidence.

15.12 FUME PIPES ANNUAL CLEANING

Clean annually from soot with brushes.

The cleaning operation must be executed by a specialized stove-repairer who will provide for the cleaning of fume pipe, chimney flue and chimney pot. He will also check their efficiency and will release a written declaration of the safety of the appliance. This operation must be executed at least once a year.

15.13 GENERAL CLEANING

For cleaning external and inner parts of the stove do not use steel wools, muriatic acid or other corrosive and abrasive materials.

15.14 CLEANING OF PAINTED METAL PANELS

To clean painted metal panels use a soft cloth. Do not use degreasant agents like alcohol, diluents, acetone, gasoline because these could irremediably damage the varnish.

15.15 CLEANING OF CERAMIC AND STONE PANELS

Some stove models has an external lining made up of ceramic or stone. These pieces are handmade therefore they could inevitably present crazings, seedinesses, shadings. To clean ceramic or stone panels use a soft and dry cloth. If using any cleaners this will seep through the crazings putting them in evidence.

15.16 SWITCHING OFF AT THE END OF THE SEASON

At the end of every season, before switching off the product, we recommend removing all the pellets from the hopper using a vacuum with a long hose.

We recommend removing the unused pellets from the hopper because they can trap moisture. Disconnect any combustion air ducts that can channel moisture into the combustion chamber, and above all, ask the specialised technician during the necessary annual scheduled maintenance appointment at the end of the season to touch up the paint inside the combustion chamber with specific silicone spray paints (that can be purchased at any retailer or customer service centre). This way, the paint will protect the internal parts of the combustion chamber, preventing rust from forming.

When not in use, the appliance must be disconnected from the electrical mains. For greater safety, especially when there are children, we recommend removing the power cable altogether.

When turning the stove back on, if the control panel display does not turn on when you press the main switch on the side of the product, it means you may need to replace the service fuse.

There is a fuse holder compartment on the back of the product, under the power plug. After having disconnected the plug from the mains, use a screwdriver to open the fuse holder compartment cover and, if necessary, replace the fuses (3.15 A time delay).

15.17 CHECKING THE INNER COMPONENTS



ATTENTION!

Only qualified personnel with technical knowledge of combustion and electricity can check the inner electrical-mechanical components.

| | PARTS/FREQUENCY | 2-3 DAYS | 1 MOUNTH | 1 YEAR |
|--------------------------------------|-------------------------------|----------|----------|--------|
| VRT3@UNDER THE USER'S RESPONSIBILITY | Brazier* | X | | |
| | Ash pan | X | | |
| | Glass | X | | |
| | Lower compartment | X | | |
| | Turbulators | X | | |
| | Pipe units | | X | |
| BY THE QUALIFIED TECHNICIAN | Complete heat exchanger | | | X |
| | Smoke duct | | | X |
| | Door gasket | | | X |
| | Internal parts | | | X |
| | Flue | | | X |
| | Circulation pump | | | X |
| | Plumbing components | | | X |
| | Electro-mechanical components | | | X |
| | Door closure operation | | | X |

*** THE FREQUENCY OF CLEANING SHOULD BE INCREASED IF THE PELLETS ARE OF POOR QUALITY.**

We recommend this maintenance be done annually (with a scheduled service contract), which focuses on a visual and functional check of the inner components. Below is a summary of the checks and/or service that are essential for proper product operation.

- Gear motor
- Smoke extraction fan
- Smoke probe
- Ignition spark plug
- Pellet/water automatically rearming thermostat
- Room/water probe
- Motherboard
- Panel-board protective fuses
- Wiring

16 IN CASE OF ANOMALY





16.1 PROBLEM SOLVING





























Before of every Authorized Technician intervention, the same Technician has the duty to check if the parameters of the mother board correspond to those of the table you own.















In case of doubts regarding the use of the stove, please contact ALWAYS the Authorized Technician on order to avoid irreparable damages!











| PROBLEM | CAUSE | SOLUTION | INTERVENTION |
|--|---|---|---|
| The control display does not switch on | The stove is without power supply | Check if the plug is connected. |  |
| | Burned protection fuse in the electric socket | Replace the protection fuses in the electric socket (3.15A-250V). |  |
| | Faulty control display | Replace the control display. |  |
| | Faulty flat cable | Replace the flat cable. |  |
| | Faulty electronic board | Replace the mother board. |  |













| PROBLEM | CAUSE | SOLUTION | INTERVENTION |
|---|---|---|---|
| Pellets do not reach the combustion chamber | Empty hopper | Full the hopper. |  |
| | Open fire door or open pellet door | Close fire door and pellet door and check that there are no pellet grains at the gasket level. |  |
| | Clogged stove | Fume chamber cleaning |  |
| | Auger blocked by a foreign object (for example nails) | Clean the auger. |  |
| | The auger geared motor is out of order | Replace the geared motor. |  |
| | Check if on the display there is an "ACTIVE ALARM" | Have the stove checked. |  |
| The fire extinguish and the stove stops | Empty hopper | Full the hopper. |  |
| | Auger blocked by a foreign object (for example nails) | Clean the auger. |  |
| | Bad quality pellets | Try other types of pellets. |  |
| | Pellet drop value too low "phase 1" | Adjust the pellet loading. |  |
| | Check if on the display there is an "ACTIVE ALARM" | Have the stove checked. |  |
| | The pellet temperature safety probe has tripped | Let the boiler cool down, reset the thermostat until the problem is resolved, then switch the boiler back on; if the problem persists, contact customer service |  |
| | The door does not close perfectly or the gaskets are worn | Close the door and have the gaskets replaced with other original ones |  |
| | Unsuitable pellets | Change the type of pellets with one that is recommended by the manufacturer |  |

| PROBLEM | CAUSE | SOLUTION | INTERVENTION |
|--|--|---|---|
| | Broken or defective manostat | Replace the manostat |  |
| | Ignition step is not completed | Repeat ignition |  |
| | Temporary power outage | Wait for automatic restart |  |
| | Clogged smoke duct | Clean the smoke duct |  |
| | Defective or broken temperature probes | Check and replace probes |  |
| | Faulty spark plug | Check and, if necessary, replace the spark plug |  |
| Flames are weak and orange coloured, pellets do not burn properly and the glass blackens | Not sufficient combustion air | Check as following: probable obstructions of the combustible air inlet from the back or from the bottom of the stove; burning pot obstructed holes with too ash remains. Have the fan blades and auger cleaned. |  |
| | Obstructed exhaust | The exhaust chimney is partially or totally obstructed. Contact an expert stove-repairer who checks the stove from the exhaust up to the chimney pot. Provide immediately for stove cleaning. |  |
| | Obstructed stove | Provide immediately at the inner cleaning of the stove. |  |
| | The fume fan is out of order | The pellets can burn also thanks to chimney flue depression without the aid of the fume fan. Have the fume fan immediately replaced. It can be noxious to health to let the stove running without fume fan. |  |
| | Damp or unsuitable pellets | Change the type of pellet |  |
| The exchanger fan continues to turn even though the stove has just cooled | Faulty fume temperature probe | Replace the fume probe. |  |
| | Faulty mother board | Replace the mother board. |  |

| PROBLEM | CAUSE | SOLUTION | INTERVENTION |
|---|--|---|---|
| Ash remains along the stove | Faulty or out of order door gaskets | Replace the gaskets. |  |
| | Not sealed fume pipes | Contact an expert stove-repairer who will immediately provide for sealing the junctions with high-temperature silicone and/or for replacing pipes with those in compliance to current regulations. A not sealed fume channelisation can be noxious to health. |  |
| The stove is at its highest power but does not heat up. | Ambient temperature reached. | The stove is at its minimum value. Increase the desired ambient temperature. |  |
| Stove running and display showing "Smoke Overtemperature" | Reached fume outlet limit temperature | The stove runs at minimum. NO PROBLEM! |  |
| The smoke extraction motor is not working | No power to the boiler | Check the mains voltage and the protective fuse |  |
| | The motor is broken | <i>Check the motor and capacitor and, if necessary, replace them</i> |  |
| | The motherboard is defective | <i>Replace the electronic board</i> |  |
| | The control panel is broken | <i>Replace the control panel</i> |  |
| The stove's smoke duct produces condensation | Low smoke temperature | Check that the flue is not clogged. |  |
| | | Increase stove power to minimum (pellet drop and fan revs). |  |
| | | Install condensation collection cup. |  |
| Stove running and display showing "SERVICE" | Routine maintenance alert (it does not block the system) | When this flashing message appears upon start-up, it means that the preset operating hours have elapsed before maintenance. Contact the service centre. |  |

16.2 PROBLEM SOLVING (THERMOSTOVE)

| PROBLEM | POSSIBLE CAUSES | SOLUTIONS | INTERVENTION |
|---|--|--|---|
| In automatic position, the boiler always works at maximum power | Thermostat set to the minimum | Reset the thermostat temperature |  |
| | Room thermostat in a position that always detects cold | Change the position of the thermostat |  |
| | Faulty temperature detection probe | <i>Check and, if necessary, replace the probe</i> |  |
| | Defective or broken control panel | <i>Check and, if necessary, replace the panel</i> |  |
| The boiler does not start | Power outage | Make sure the power cable is plugged in and the main switch is in the "I" position. |  |
| | Blocked pellet probe | <i>Release it via the rear thermostat. If it happens again, call customer service.</i> |  |
| | Broken fuse | Replace the fuse |  |
| | Broken manostat (block signal) | Low water pressure in the boiler |  |
| | Clogged smoke duct or exhaust | Clean the smoke exhaust and/or smoke duct |  |
| | Water temperature probe has tripped | Call customer service |  |

| PROBLEM | POSSIBLE CAUSES | SOLUTIONS | INTERVENTION |
|---|---|---|---|
| Temperature does not increase with the boiler working | Improper combustion adjustment | Check recipe and parameters |  |
| | Dirty boiler/system | Check and clean the boiler |  |
| | Insufficient boiler power | Make sure the boiler is appropriately proportional to the system requirements |  |
| | Poor quality pellets | Use quality pellets |  |
| Condensate in the boiler | Improper temperature adjustment | <i>Adjust the boiler to a higher temperature</i> |  |
| | Insufficient fuel consumption | <i>Check the recipe and/or technical parameters</i> |  |
| Radiators cold in the winter | Room thermostat (local or remote) adjusted too low. If remote thermostat, check whether it is defective | <i>Adjust it to a higher temperature. Replace it if necessary (if remote).</i> |  |
| | The circulator does not turn because it is blocked | <i>Release the circulator by removing the cap and turning the shaft with a screwdriver.</i> |  |
| | The circulator does not turn | <i>Check its electrical connections, replace it if necessary.</i> |  |
| | Air inside the radiators | <i>Bleed the radiators</i> |  |
| No hot water comes out | Circulator (pump) blocked | Release the circulator (pump) |  |
| Noise and gurgling | Air in the system | Vent the air and fill the system |  |

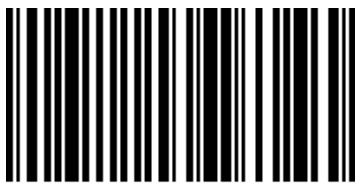

89020155A

Rev. 00 - 2022

CADEL srl
31025 S. Lucia di Piave - TV
Via Foresto sud, 7 - Italy
Tel. +39.0438.738669
Fax +39.0438.73343

www.cadelsrl.com
www.free-point.it
www.pegasoheating.com