



PELLET STOVE

AKI Hydromatic 16/24 M1

PART 2 - OPERATION AND CLEANING

Instructions in English

The logo for MCZ, consisting of the letters 'MCZ' in a bold, stylized, black font. The 'M' and 'C' are connected, and the 'Z' is separate.

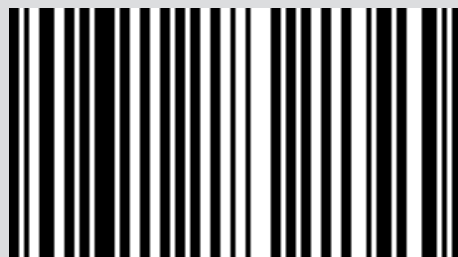

8902006600

TABLE OF CONTENTS

TABLE OF CONTENTS	II
11-PRECAUTIONS BEFORE START-UP.....	3
12-SYSTEM REQUIREMENTS.....	4
13-FIRST APP START-UP AND ASSOCIATION WITH MCZ STOVES	5
14-STOVE ACCESSORIES CONFIGURATION	8
15-EMERGENCY PANEL.....	10
16-EMERGENCY PANEL FUNCTIONS.....	11
17-MANUAL CONFIGURATION	12
18-APP FUNCTIONS.....	13
19-SIDE DROP DOWN MENU	15
20-SHORTCUTS SETTINGS / RAPID SETTINGS.....	16
21-MENU SETTINGS	20
22-OPERATION MENU.....	26
23-SETTINGS MENU	29
24-SOFTWARE VERSION	36
25-TECHNICAL MENU	37
26-INFO MENU.....	39
27-SAFETY DEVICES AND ALARMS	43
28-RECOMMENDATIONS FOR SAFE USE.....	49
29-CLEANING AND MAINTENANCE.....	50
30-TROUBLESHOOTING	57
31-CIRCUIT BOARD	60

11-PRECAUTIONS BEFORE START-UP

WARNINGS BEFORE IGNITION

GENERAL WARNINGS

Remove all parts that may burn from the brazier and the glass (manual, various adhesive labels or any polystyrene).

Check that the brazier is positioned correctly and rests properly on the base.



The first start-up may not be successful as the feed screw is empty and does not always manage to load the brazier with the required amount of pellets in time to light the flame.



**CLEAR THE FAILED IGNITION ALARM FROM THE STOVE PANEL OR APP.
REMOVE THE PELLETS LEFT IN THE BRAZIER AND REPEAT IGNITION. (SEE "SAFETY DEVICES/ALARMS" PARAGRAPH)**

If, after repeated attempts, the flame fails to ignite, despite a regular flow of pellets, check the correct positioning of the brazier, which **must rest snugly against the slots**. If no anomaly is found during this inspection, there may be a problem with the product components or installation may not be correct.



REMOVE THE PELLETS FROM THE BRAZIER AND CONTACT AN AUTHORISED TECHNICIAN.



Do not touch the stove during the first start-up, as it is during this phase that the paint sets. If you touch the paint, you may expose the steel surface.



It is good practice to ensure effective ventilation in the room during the initial start-up, as the stove will emit some smoke and smell of paint.

If necessary, touch up the paint with the spray can of the specific colour.

Do not stand close to the stove and, as mentioned, air out the room. The smoke and smell of paint will disappear after about an hour of operation, however, they are not harmful in any case.



The product will be subject to expansion and contraction during the start-up and cooling stages, therefore slight creaking noises may be heard. This is absolutely normal and must not be considered a defect as the structure is made of laminated steel.

Upon **first ignition**, for the first pellet hopper, it is recommended to start the stove at maximum power so that the structure and the smell of the paint settle more quickly.

It is recommended to install the ceramic or serpentine stone cladding after the first successful ignition.



DO NOT EXPECT HEATING EFFICIENCY IMMEDIATELY!!!

12-SYSTEM REQUIREMENTS

APP

The **MCZ Maestro** App is already available on the “Handheld remote control” accessory or will be available in various playstores.

STOVE

Equipped with MAESTRO system

OPERATION

For the utmost versatility of use, two Wi-Fi modules have been designed, supporting priority connection with your smartphone and/or handheld remote control (optional).

The stove's operating status, room temperature, operating parameters (such as ventilation, power, etc.) and any alarms may be checked remotely.



Attention!

The App is already available in English on the “Handheld remote control” accessory as the language used on the telephone is set by default. If the App is downloaded onto a personal smartphone, it similarly adopts the language already in use on the phone. In either case, it is possible to open the “LANGUAGE” screen in the app and select the desired language.

13-FIRST APP START-UP AND ASSOCIATION WITH MCZ STOVES

The app lets you communicate with MCZ stoves using two technologies:

- home Wi-Fi
- remote Wi-Fi

HOME WI-FI

Point-to-point connection between the telephone and the stove, to communicate with the stove without relying on routers or internet connections. This is possible when the telephone and stove are located nearby (we recommend max 5 metres). The range of action depends on the characteristics of the walls and how the home is structured.

REMOTE WI-FI

Connection between the app and stove using an internet connection. With this technology you can communicate with the stove from anywhere. Near the stove there must be a Wi-Fi router providing an internet connection and the mobile phone in turn must have a data connection.

The first time you start the app without having configured any devices, the app opens displaying the “*device list*” screen.

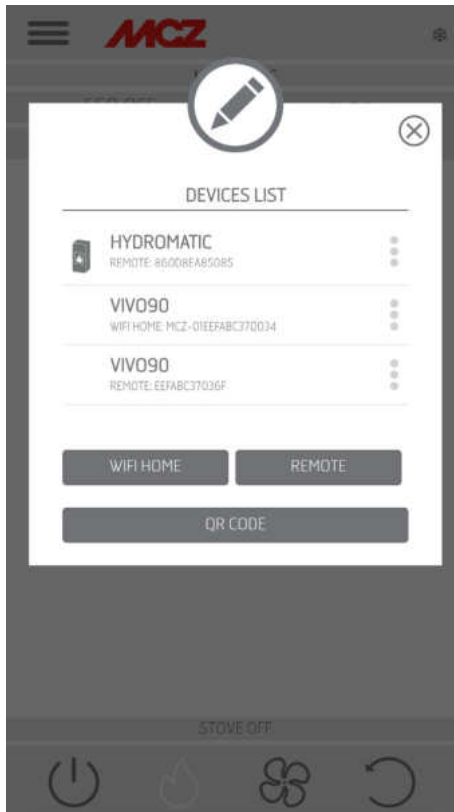

There are two ways to associate MCZ devices:

- automatically
- manually

13-FIRST APP START-UP AND ASSOCIATION WITH MCZ STOVES



IMPORTANT!! Do not lose or remove the QR code from the stove. If the stove is reset and/or the smartphone and/or handheld remote control are changed, you must have the QR code and passwords available to configure the system.

AUTOMATIC MODE

The QR code and the passwords are located at the back of the stove and in the warranty.



Home: 123456789012345678
PW D: passwordaa
S/N: 1709110060002
MAC: 1234567890 12

EXAMPLE OF QR AND PASSWORD LABEL

Scan the QR code using the camera of the device (accessory or smartphone) and acquire it.

When the code is acknowledged, the app will ask you to enter an identification number for the stove (for example "living room stove") to easily identify the stove/s in the list of configured devices.

This will automatically configure the app to work with both home WI-FI and remote WI-FI technology.

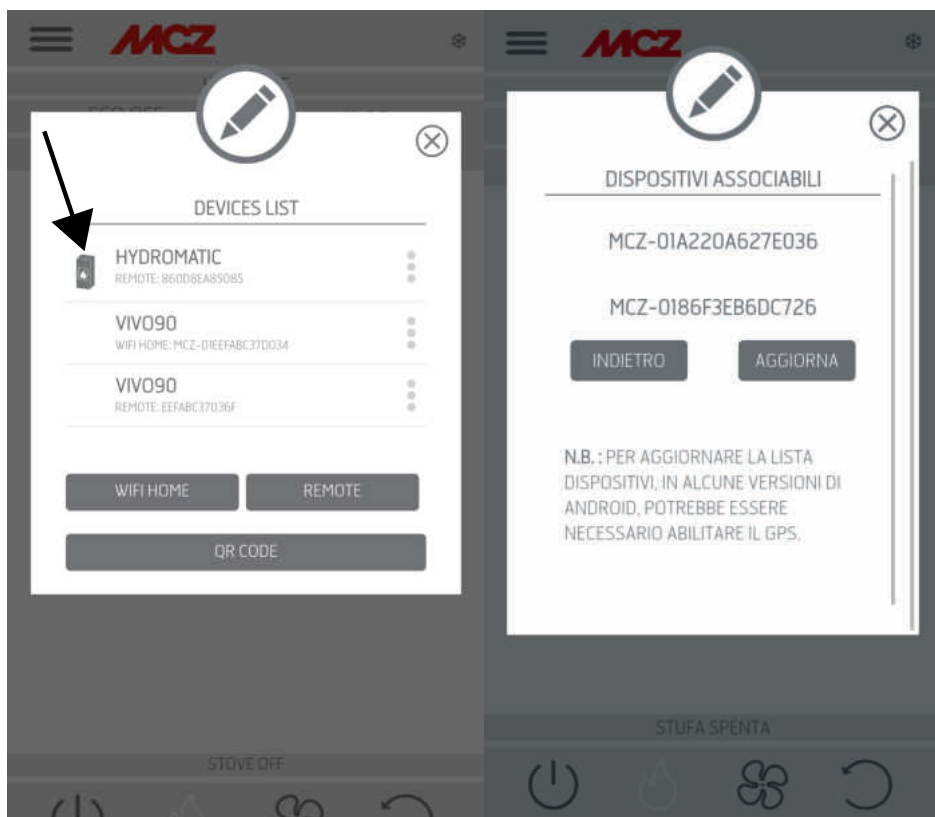

13-FIRST APP START-UP AND ASSOCIATION WITH MCZ STOVES

MANUAL MODE

The QR code and the passwords are located at the back of the stove and in the warranty. In this case, the codes must be used.



Home: 123456789012345678
PWD: passwordata
S/N: 1709110060002
MAC: 123456789012

EXAMPLE OF QR AND PASSWORD LABEL

If the stove cannot be configured using the QR code, it can be done using the DIRECT or REMOTE key.

To configure operation in HOME WI-FI mode, click on the "DIRECT" key and the "select device" screen opens. The stoves nearby are scanned; select your stove and enter the password (located near the QR code at the top) and a stove identification name (for example "living room stove") to easily identify the stove/s in the list of configured devices.

To configure operation in REMOTE WI-FI mode, click on the "REMOTE" key and the "SELECT DEVICE" screen opens. Fill in all the fields with the codes on the label (near the QR code at the bottom) and a stove identification name (for example "living room stove") to easily identify the stove/s in the list of configured devices

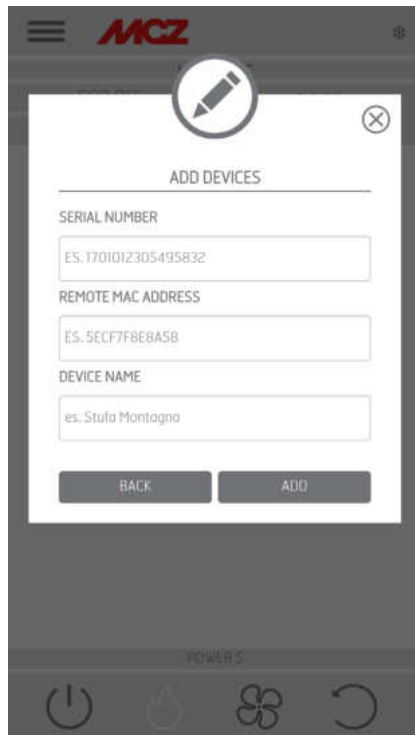
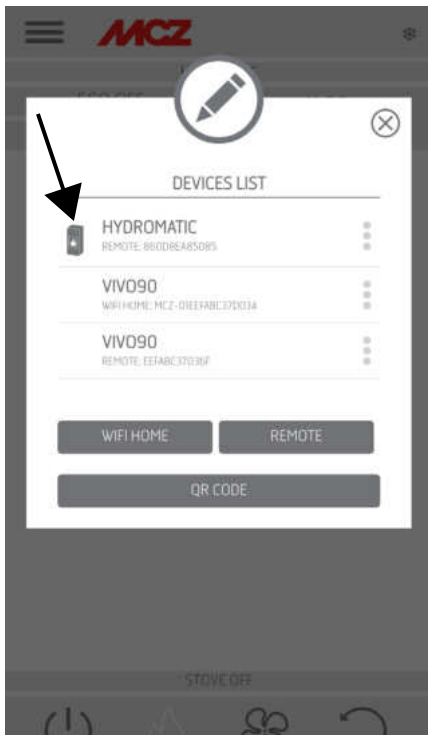

14-STOVE ACCESSORIES CONFIGURATION

Once the app has been configured, you can communicate with the stove in Home mode and also configure stove accessories from the app:

- REMOTE WI-FI module (if any)
- WI-FI temperature probe (not supplied)

In order to configure the accessories, the mobile phone must be near the accessories.

CONFIGURATION OF REMOTE WI-FI MODULE FROM MCZ MAESTRO APP

To do this, connect to the stove in home mode through the app. From the “settings” / “basic settings” menu, select the configure accessories item: if there are still accessories to be configured, the two keys can be selected.

click configure remote ----- a screen opens, displaying nearby Wi-Fi routers. Select the router providing the internet connection and enter the respective password. From now on, if the router provides a stable internet connection, it is possible to command the stove remotely.

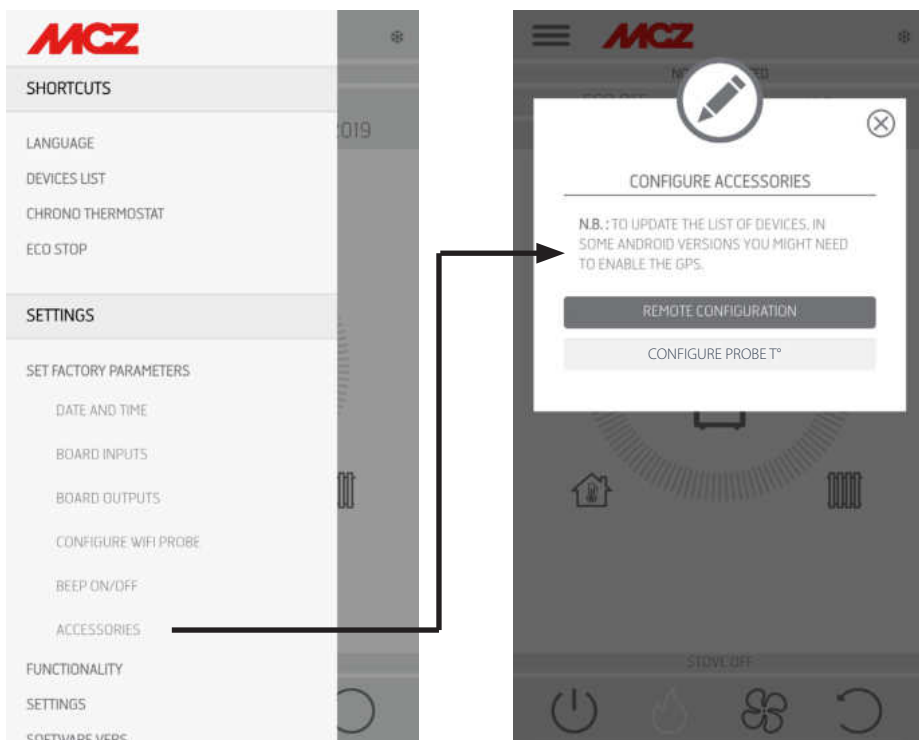

The access password to the network by the Maestro App must have a maximum of 32 characters. For longer passwords, for example generated automatically by the router upon initial installation, the length must be modified according to the procedures for your router.

Additional functions

Once the remote stove Wi-Fi module has been connected to the home router, every time the router is available, the remote stove Wi-Fi module will reconnect automatically.

If the router is replaced or the password is changed, the remote stove Wi-Fi module will revert to configuration mode as it can no longer connect.

The Wi-Fi modules have an auto-reset mechanism.

14-STOVE ACCESSORIES CONFIGURATION

CONFIGURATION OF WI-FI TEMPERATURE PROBE FROM MCZ MAESTRO APP

The Wi-Fi temperature probe (ACCESSORY) is supplied without batteries. From when the batteries are inserted, the probe can be configured within the next 8 minutes. Therefore insert the three AA batteries shortly before you are ready to proceed with the configuration.

Then:

- insert two batteries immediately, then insert the third after placing the sensor next to the Wi-Fi emergency panel (approximately 2 cm)
- wait for the beep-beep indicating that pairing has successfully occurred (it must occur within 10")
- connect to the stove through the app in home mode
- access the settings - basic settings - accessories menu - selecting the configure accessories item

If the Wi-Fi temperature probe is available for configuration, the key can be selected, while if the key stays disabled check that the probe

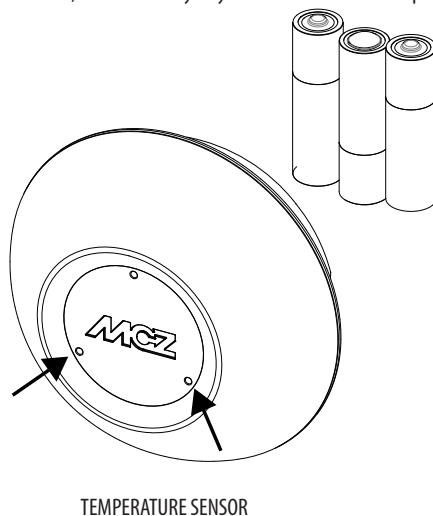

batteries are charged, or check that the maximum available time has not elapsed.

In this case, remove the batteries and put them back in, or press the reset button by inserting a paper clip in the hole to the right of the sensor dome. From this time on, the 8 minutes for configuration start over again.

If the probe is ready for configuration click the key in the app screen, click **T° probe configuration** ----- the screen will show the stoves that the Wi-Fi probe can be associated with; select your stove and enter the home Wi-Fi password (see QR code label).

Once the Wi-Fi probe is connected, you can configure the stove to use the remote sensor; to do this use the shortcut by clicking on the temperature indicator at the top right of the app screen and select the "Wi-Fi probe" as the temperature input. Or from the setup menu choose to configure ambient input and select the "Wi-Fi probe" temperature input.



Should it be necessary to reset the Wi-Fi probe, because already coupled to another device or configured incorrectly, use two paper clips. With the first one, press and hold the key below the bottom left hole and with the other one, press the key below the right hole once.

Repeat the configuration procedure indicated at the start of the page.

15-EMERGENCY PANEL

At the back of the stove, there is the emergency panel that provides some information about the stove status.

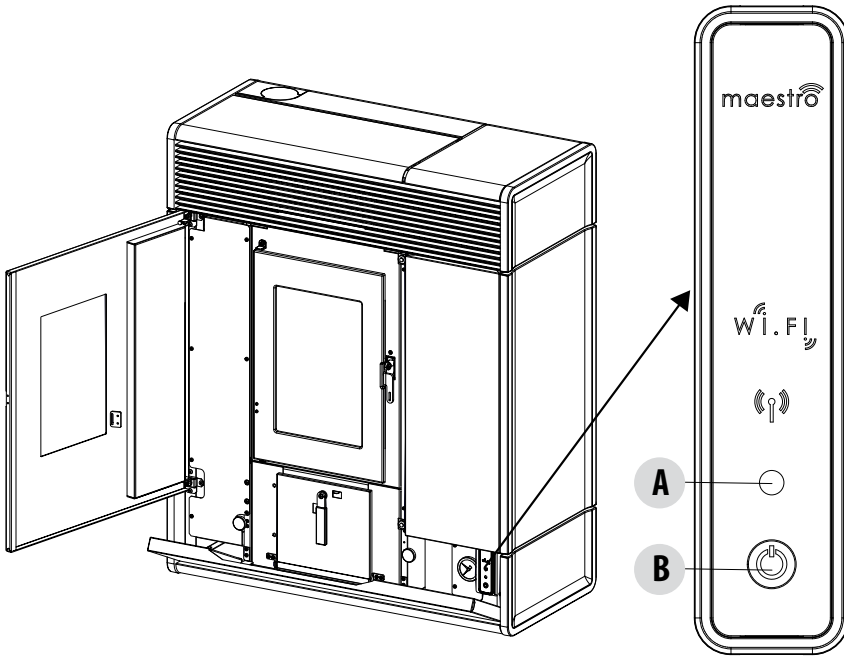

KEY

A - MULTICOLOUR LED

Green LED that indicates:

- Stove in OPERATION

Red LED that indicates:

- Stove OFF

Blue LED that indicates:

- Stove START-UP

Yellow LED that indicates:

- Stove cooling for SHUTDOWN

Flashing red LED that indicates:

- Stove in ALARM conditions

B - BUTTON - functions

Turns the product ON

Turns the product OFF

Changes the operating POWER:

- 1 beep = LOW
- 3 beeps = MEDIUM
- 5 beeps = HIGH

RESET ALARMS

16-EMERGENCY PANEL FUNCTIONS

The emergency panel provides the following information:

- through a multicolour LED (A) it provides information about the stove status (off-starting-up-in operation-cooling for shutdown- in error conditions)
- using the button (B) the following functions can be activated:
 - if the product triggered an error ----- reset the error by pressing the key for more than 3 seconds
Attention! Alarms A01, A02, A03, A05 and A21 can only be reset from the panel and not from the app.
 - if the product is off ----- switch it on (press the key for more than 3 seconds)
 - if the product has completed the ignition procedure (green LED on), press the key (briefly for 0.5 seconds) to change the power according to this diagram:
 - LOW flame power 1 and ventilation level 1
 - MEDIUM flame power 3 and ventilation level 3
 - HIGH flame power 5 and ventilation level 5

Every time the power is changed, a buzzer will indicate the selected power on the stove:

- 1 beep LOW
- 3 beeps MEDIUM
- 5 beeps HIGH

If the product is running, switch it off by pressing the key for 3 seconds.



Attention! If the user erroneously presses the button for more than 10 seconds with the stove off, this will automatically place the stove in download mode to update the firmware (operation restricted to an authorised technician). This way, the stove remains in standby, with an intermittent buzzer, for a USB flash drive containing the firmware update. If a USB flash drive is not inserted, the stove exits this mode after 10 seconds.

17-MANUAL CONFIGURATION

If the remote Wi-Fi and temperature probe configurations do not work automatically, you must proceed with manual configuration.

MANUAL REMOTE WI-FI MODULE CONFIGURATION

From mobile phone -> Wi-Fi settings menu, Wi-Fi needs to be enabled on the mobile phone.

Search for "MCZ-RemoteService" from among the Wi-Fi networks available and connect to it (no password is required since it is an open network).

Once connected to the following network, open the phone's browser and enter the following address: 192.168.1.1.

A screen opens, displaying nearby Wi-Fi routers. Select the router providing the internet connection and enter the respective password.

From now on, if the router provides a stable internet connection, it is possible to control the stove remotely.

Note: when the remote Wi-Fi module is configured correctly and connected to a router, the "MCZRemote Service" network disappears from the list of available Wi-Fi networks.

MANUAL WI-FI TEMPERATURE PROBE CONFIGURATION

Once the 3 AA batteries are installed, the Wi-Fi temperature probe remains configurable for 8 minutes (ATTENTION! Only insert the batteries just before proceeding with configuration).

Insert the batteries and start the procedure.

From mobile phone -> Wi-Fi settings menu, Wi-Fi needs to be enabled on the mobile phone.

Search for "MCZ-Sensor" from among the Wi-Fi networks available and connect to it (no password is required since it is an open network)

Once connected to the following network, open the phone's browser and enter the following address: 192.168.1.1.

A window opens that displays the stoves that can be associated with the Wi-Fi probe. Select your stove and enter the Wi-Fi Home password (on the QR code label)

Once the Wi-Fi probe is connected, you can configure the stove to use the remote sensor; to do so, open the MCZ MAESTRO APP, connect to your previously configured stove, use the shortcut by clicking on the temperature indicator at the top right of the app screen and select the "Wi-Fi probe" as the temperature input.

Or from the setup menu -> configure ambient input and select the "Wi-Fi probe" temperature input

Notes: when the Wi-Fi temperature sensor has been configured correctly and connected to your MCZ stove, the "MCZ-Sensor" network disappears from the list of available Wi-Fi networks.

18-APP FUNCTIONS

Once the devices are configured, the App will automatically try to connect to the last device used. If connection is successful, the App will display the "I/O" screen. It is possible to switch on and use all stove functions from here.

If it tries to connect to the last connected device and something goes wrong, the App will display the list of configured devices.

Click the device you want to connect to for connection.

When connected, the icon of a stove together with the name of the selected stove will appear.

It is now possible to access all stove functions.

I/O SCREEN

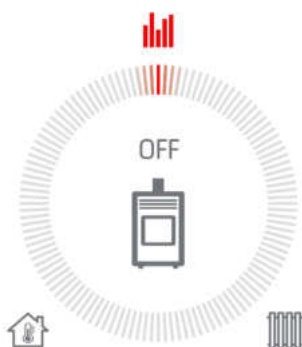

- ON/OFF KEY**
- START-UP
 - SHUTDOWN



SWITCHING THE EQUIPMENT OFF

To switch the equipment off, press and hold the ON-OFF button on the remote control or on the APP. The acoustic beep confirms this phase has started.

Alternatively, switch it off from the emergency panel by following the instructions provided in the dedicated chapter

The equipment will start the shutdown process which involves consuming the residual pellets in the brazier, the latter being cleaned and the residual heat in the structure being dissipated.

During the residual heat dissipation phase, the fans operate at about 80% of their output and the speed cannot be varied. This is determined by the need for all the accumulated heat to be evacuated safely and quickly. The shutdown stage can last 15 - 30 minutes depending on the heat stored in the structure, determined by the duration and the operating speed of the product throughout the day.

When the internal temperature drops below the set thresholds, the fans for hot air and exhaust smoke extraction will automatically switch off.

18-APP FUNCTIONS

FAN SCREEN

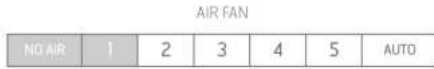

This screen manages the fan power of each single fan.

There are 5 power levels that can be set.

Each fan has the option of automatic operation and the option to switch off the fan

If the ventilation is set MANUALLY, the function which limits the maximum power of the stove according to the ventilation is enabled.

COMFORT AIR (3 FANS): maximum power level = total of the ventilation levels/2

AIR: maximum power level = twice the total of the levels of ventilation

19-SIDE DROP DOWN MENU

SET SCREEN

The menu can be selected on the top left of the three lines and includes SHORTCUTS (shortcut and / or quick settings)

- LANGUAGE
 - LIST OF DEVICES
 - CHRONOTHERMOSTAT
 - ECOSTOP
- SETTINGS
- BASIC SETTINGS
 - DATE AND TIME
 - BOARD INPUTS
 - BOARD OUTPUTS
 - CONFIGURE WIFI PROBE
 - BEEP ON / OFF
 - ACCESSORIES
 - MODE
 - CHRONOTHERMOSTAT
 - ECO STOP
 - SLEEP
 - SETTINGS
 - FEED SCREW ON
 - RECIPES
 - SUMMER/WINTER
 - PELLET SENSOR
 - BRAZIER CLEANING
 - ANTI-FREEZE
 - SOFTWARE VERSION
 - TECHNICAL MENU
 - INFO

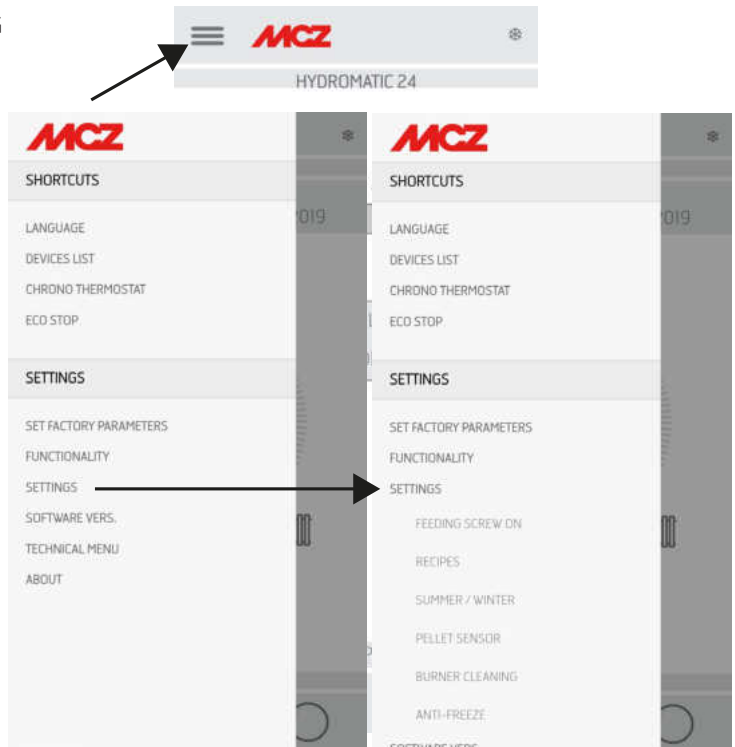

20-SHORTCUTS SETTINGS / RAPID SETTINGS

SHORTCUTS (shortcut and / or quick settings)

- LANGUAGE
- LIST OF DEVICES
- CHRONOTHERMOSTAT
- ECOSTOP

LANGUAGE SCREEN

Entering the side menu, select LANGUAGE and the system will display all the languages available. Select the desired language.

Press the SAVE button to confirm the chosen language.

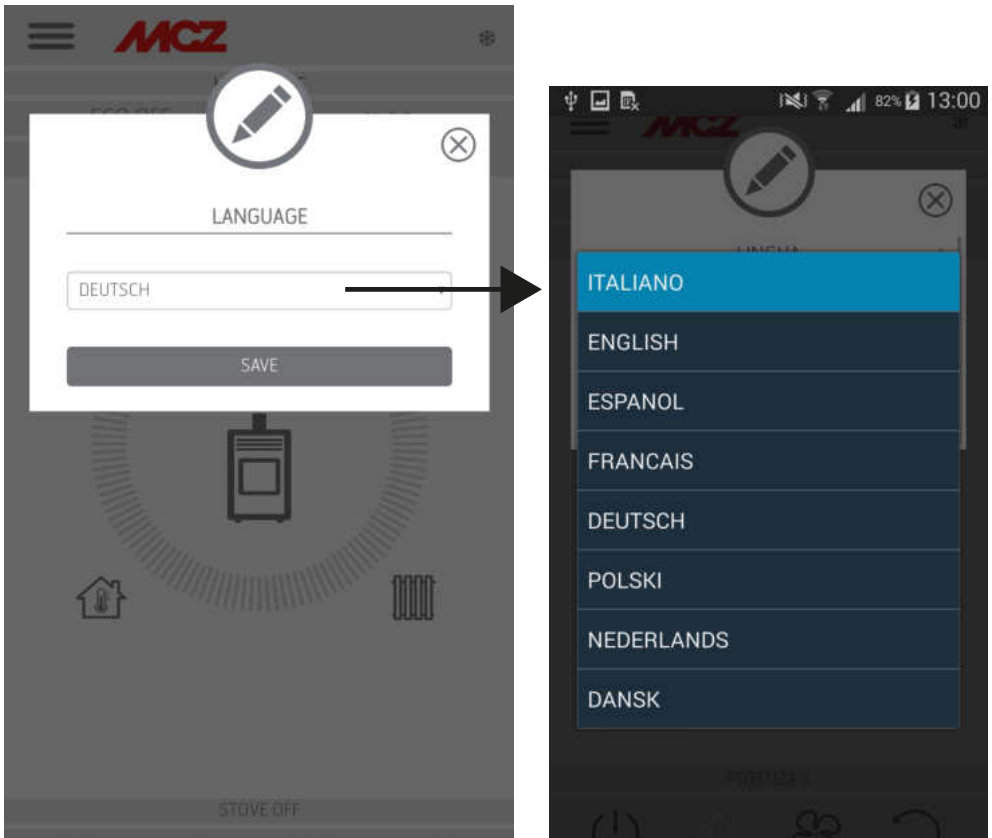

20-SHORTCUTS SETTINGS / RAPID SETTINGS

LIST OF DEVICES

This screen displays which devices have been configured. Only the device depicting the icon of a stove next to it can be selected. From the menu next to the configured device it is possible to access the MODIFY or DELETE function.

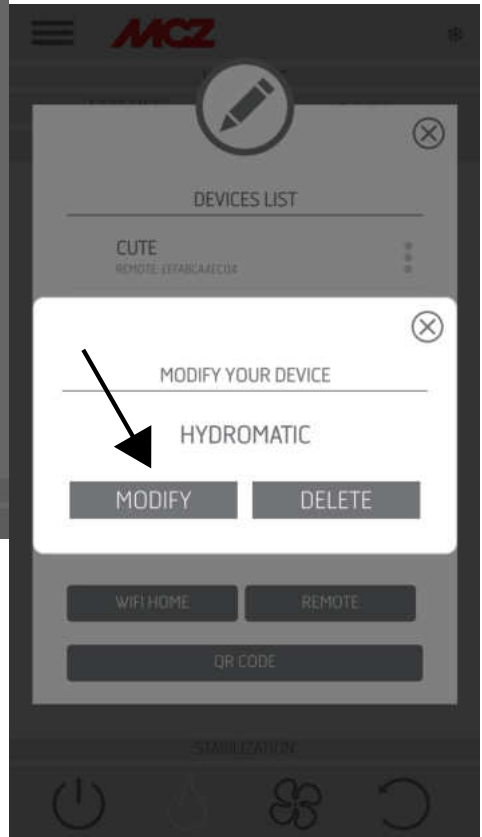
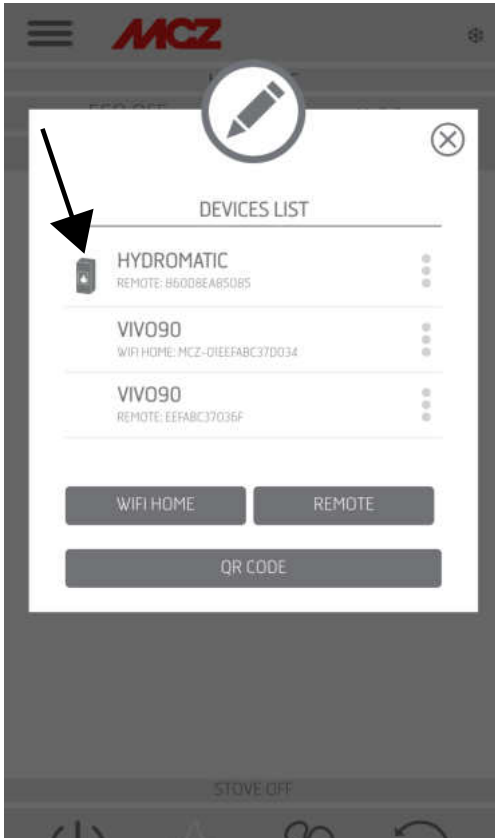

20-SHORTCUTS SETTINGS / RAPID SETTINGS

CHRONOTHERMOSTAT

Temperature selection option (T1-T2-T3)

Option to set the weekly programs.

Option to set different temperatures for different days of the week and different time bands.

To switch the chronothermostat on/off, press CHRONO ON/OFF on the Home screen of the application.

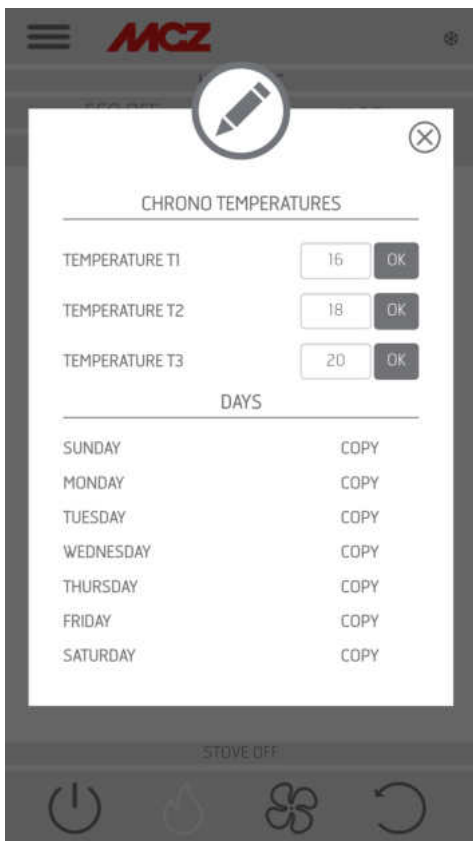

20-SHORTCUTS SETTINGS / RAPID SETTINGS

ECOSTOP

From the **ECO STOP** menu, it is possible to set and/or edit delayed activation (min) and Reignition hysteresis (C°).

ECO is an automatic mode with the only difference that if the set temperature is reached and remains so for the time (in minutes) that was selected from the delayed activation drop-down menu (value ranging between 5 and 30 minutes), the product switches off and remains in stand-by until the room temperature drops below the desired temperature (hysteresis frequency ranges between 2 and 5 minutes). The product then switches back on again.

If the room is not sufficiently insulated, flame modulation does not allow the set temperature to stay satisfied for the set time and the product will not switch off.

NOTE: It is recommended to use the ECO mode only in well-insulated rooms in order to prevent start-up and shutdown from occurring within short periods of time.

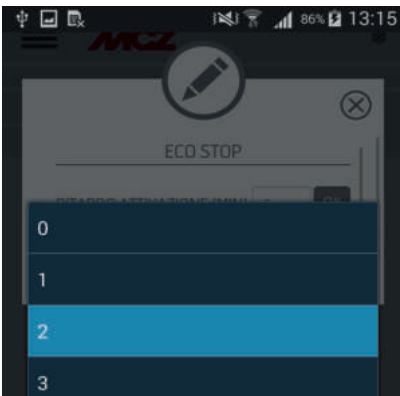
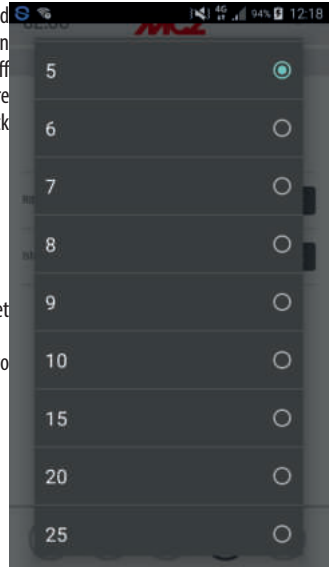

21-MENU SETTINGS

BASIC SETTINGS

- DATE AND TIME
- BOARD INPUTS
- BOARD OUTPUTS
- CONFIGURE WIFI PROBE
- BEEP ON / OFF
- ACCESSORIES

DATE AND TIME

Press the DATE AND TIME key to access the screen to edit data. After setting the data, press SAVE and exit the screen.

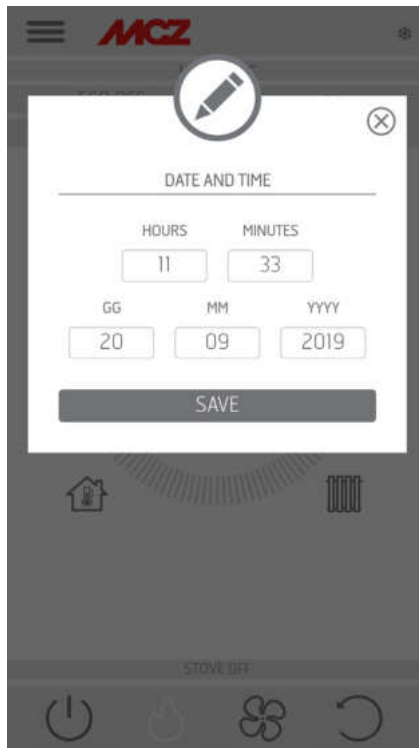

21-MENU SETTINGS

BOARD INPUTS

Room input is used to set the Wi-Fi probe, thermostat or room probe.
Click the drop-down menu to select the desired option.

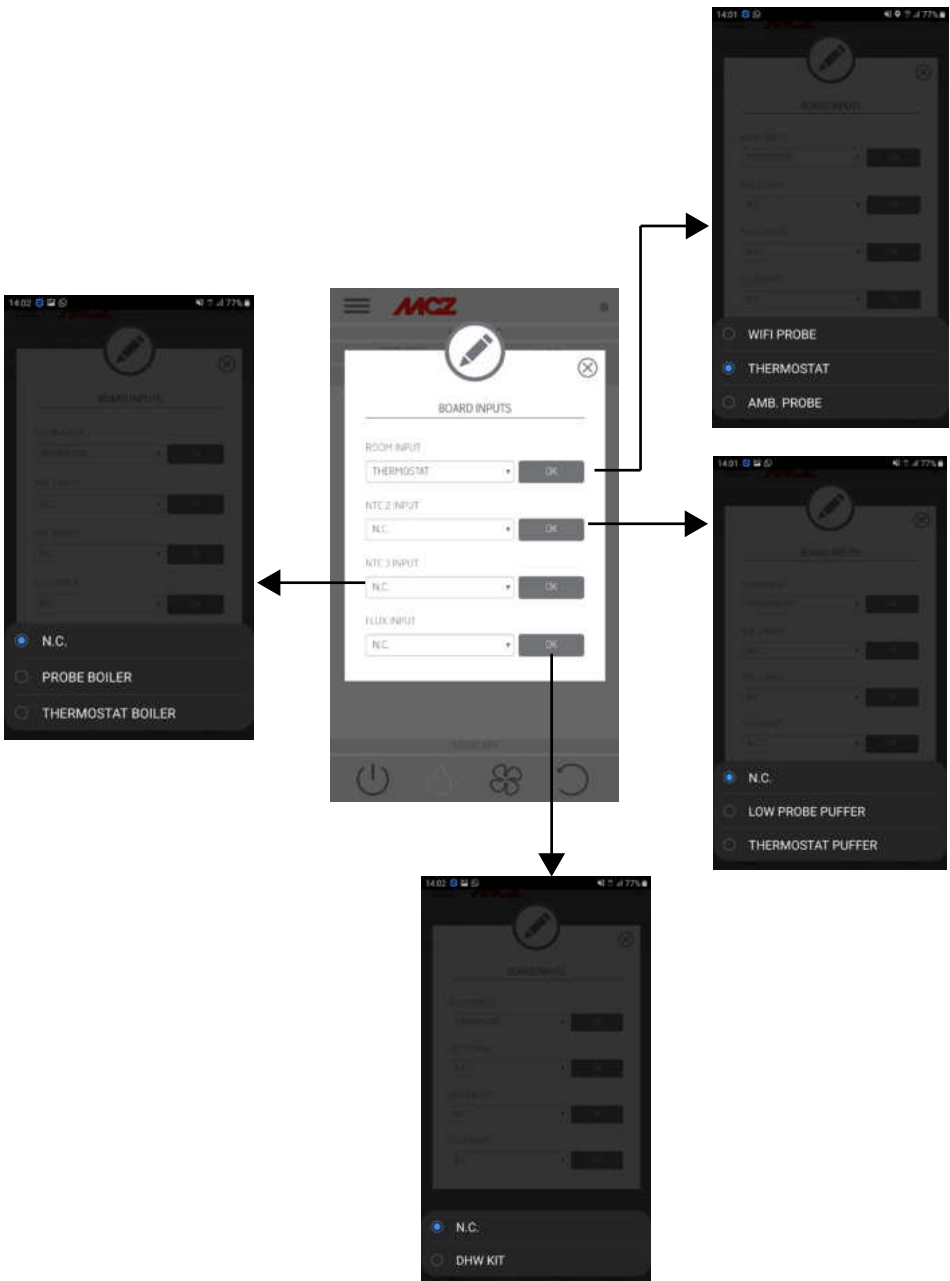

21-MENU SETTINGS

BOARD OUTPUTS

This item allows you to configure the behaviour of the auxiliary relay connected to contacts 7-8-9 as per connections table.

- Puffer Pump: select this item to activate the auxiliary relay when there is a heating demand by the NTC1 room input
- Output in temp: you may configure a temperature threshold above which the relay is active
- Aux Boiler: the relay may be used to activate an auxiliary boiler, in the stages when the pellet stove is not yet operational
- Remote alarm: the relay may be used to signal the alarm status of the pellet stove.

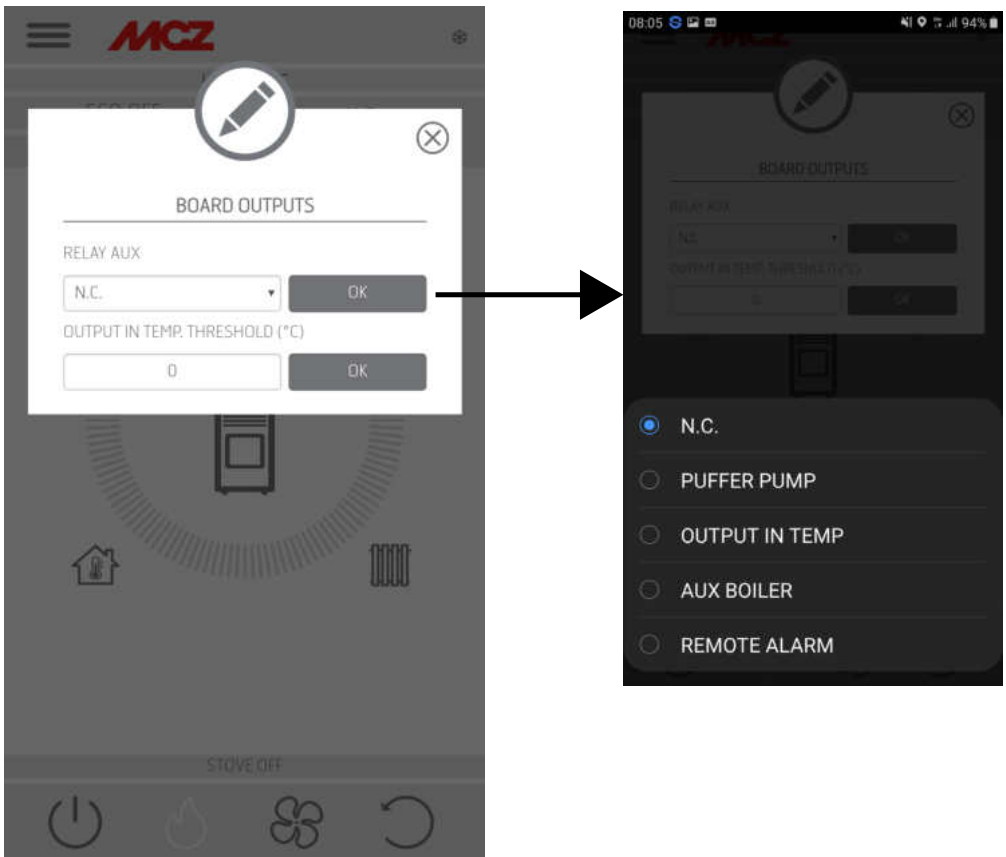

21-MENU SETTINGS

CONFIGURE WIFI PROBE

This screen configures the frequency (in minutes) and shows the last connection made.

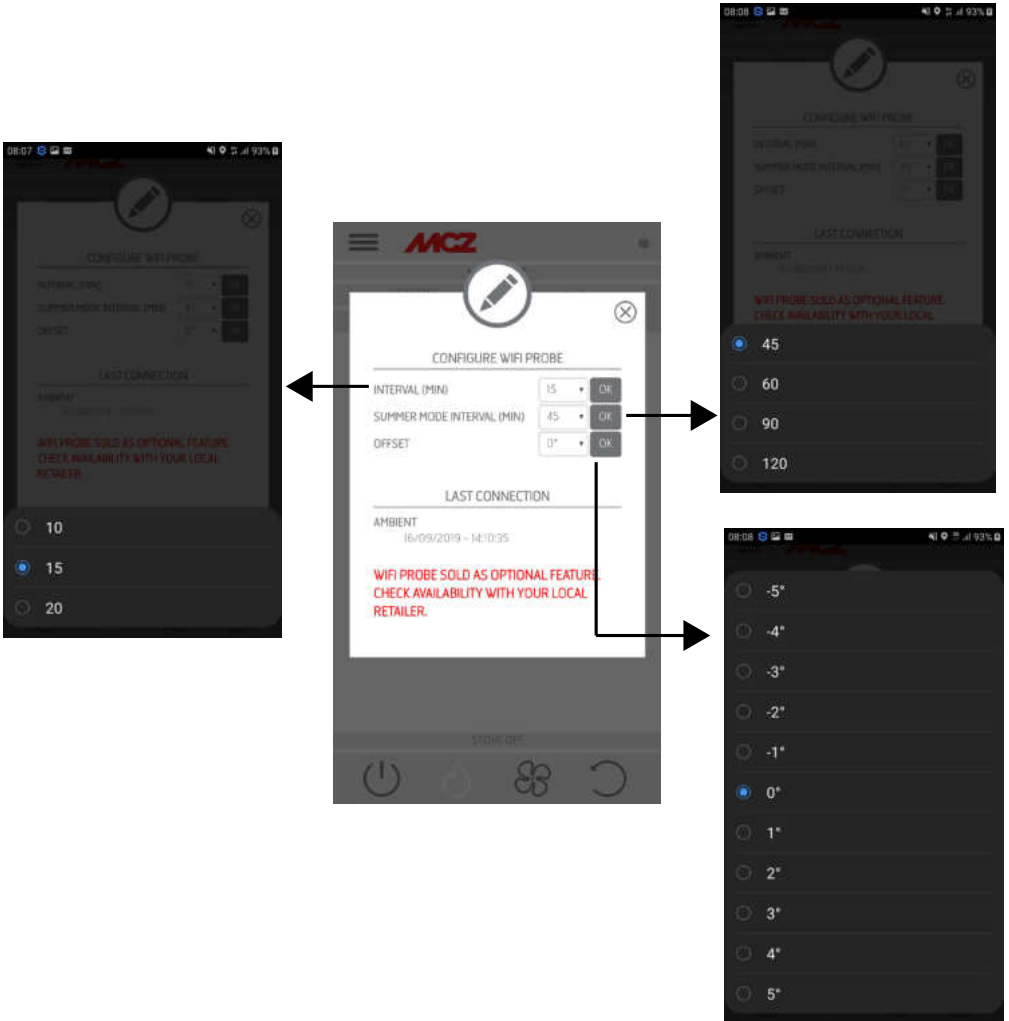

21-MENU SETTINGS

BEEP ON / OFF

This function is used to enable/disable the tones.

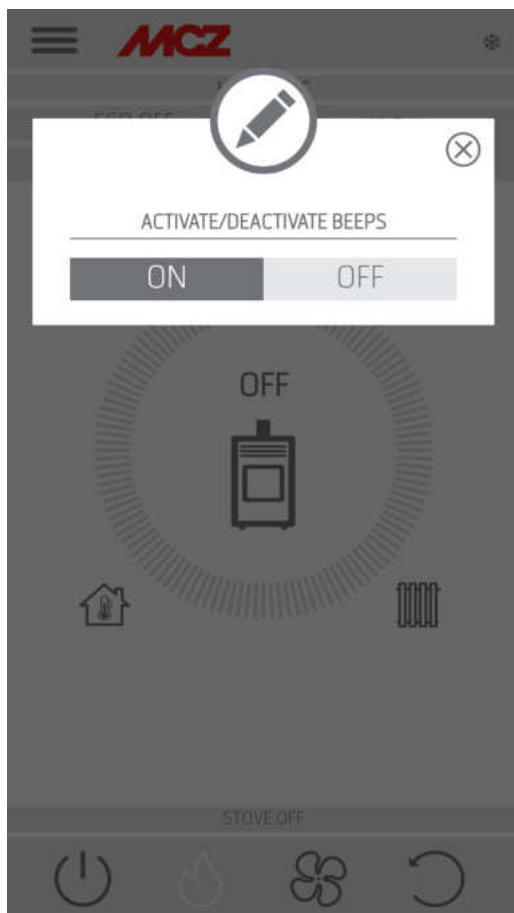

21-MENU SETTINGS

ACCESSORIES

Entering the ACCESSORIES menu it is possible to CONFIGURE:

- REMOTE CONFIGURATION
- T PROBE CONFIGURATION

Refer to Chapter 3 (“Configure stove accessories”) for the mode.

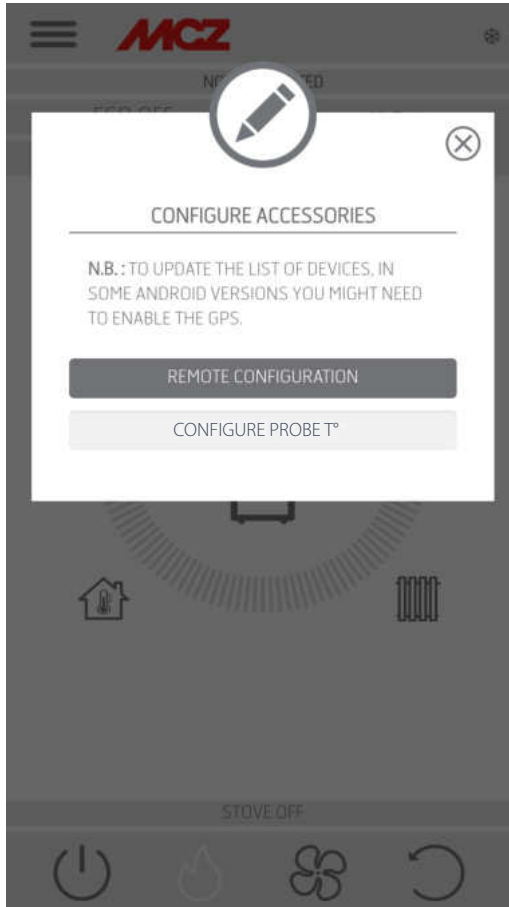

22-OPERATION MENU

MODE

- CHRONOTHERMOSTAT
- ECO STOP
- SLEEP

CHRONOTHERMOSTAT

Temperature selection option (T1-T2-T3)

Option to set the weekly programs.

Option to set different temperatures for different days of the week and different time bands.

To switch the chronothermostat on/off, press CHRONO ON/OFF on the Home screen of the application.

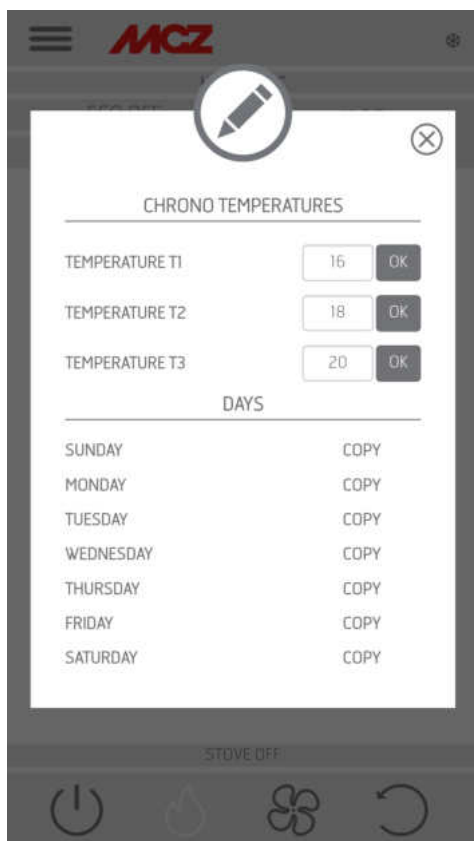

22-OPERATION MENU

ECOSTOP

From the **ECO STOP** menu, it is possible to set and/or edit delayed activation (min) and Reignition hysteresis (C°).

ECO is an automatic mode with the only difference that if the set temperature is reached and remains so for the time (in minutes) that was selected from the delayed activation drop-down menu (value ranging between 5 and 30 minutes), the product switches off and remains in stand-by until the room temperature drops below the desired temperature (hysteresis frequency ranges between 2 and 5 minutes). The product then switches back on again.

If the room is not sufficiently insulated, flame modulation does not allow the set temperature to stay satisfied for the set time and the product will not switch off.

NOTE: It is recommended to use the ECO mode only in well-insulated rooms in order to prevent start-up and shutdown from occurring within short periods of time.

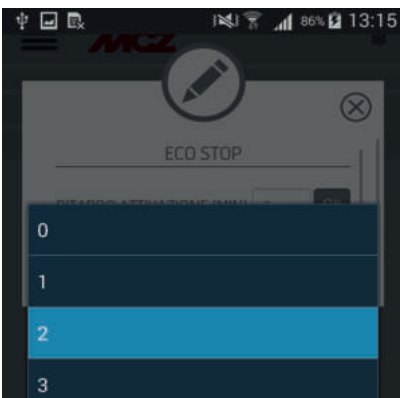
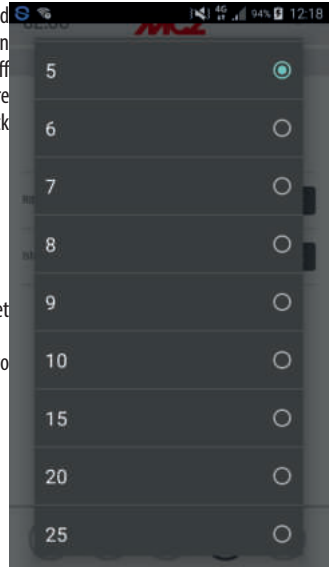

22-OPERATION MENU

SLEEP

Sleep mode allows to quickly set the time when the product must switch off. This function is only available in MAN and AUTO mode. To enable or disable the SLEEP function, touch the relative key.

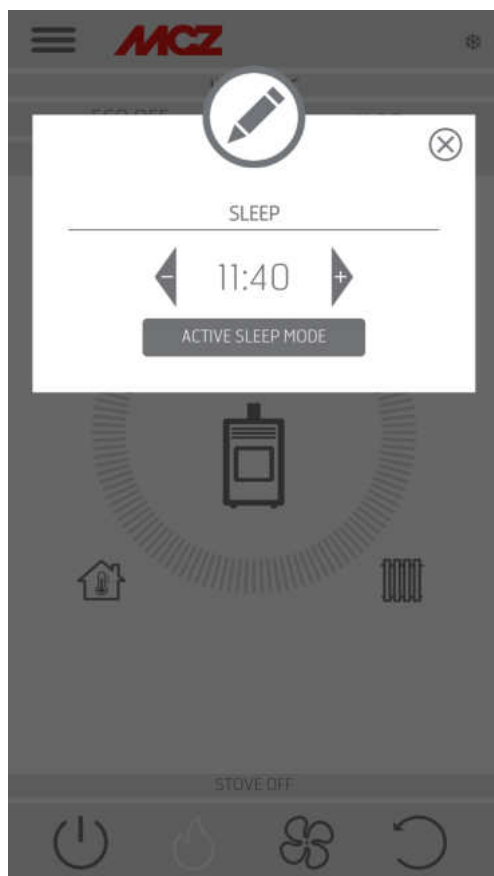

23-SETTINGS MENU

SETTINGS

- FEED SCREW ON
- RECIPES
- SUMMER/WINTER
- PELLET SENSOR
- BRAZIER CLEANING
- ANTI-FREEZE

FEED SCREW ON

This function, which can only be activated with the stove off, enables you to load pellets into the loading system (feed screw), and is used every time pellets in the hopper run out.

It is useful to prevent failed start-ups (alarm A01) due to the hopper being empty.

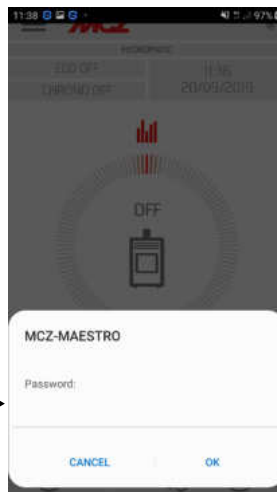
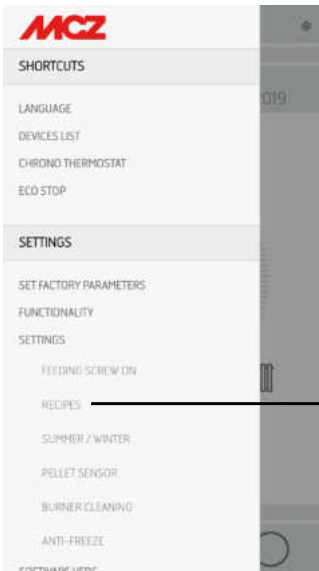

RECIPES

To enable this function, enter the SETTINGS menu and select RECIPLE. The POP-UP appears prompting the password, enter 1234. You may now edit the two functions: AIR RECIPLE and PELLET RECIPLE.

23-SETTINGS MENU

Modifying the pellet recipe and air recipe

This function is for adapting the stove to the type of pellet in use. In fact, since there are many types of pellets on the market, operation of the

stove varies significantly depending on the good or poor quality of the fuel.

The amount of pellets in the brazier can be increased or reduced:

- If the pellets tend to jam in the brazier due to an excess of fuel
- If the flame is increasingly higher even at low power values
- If the flame is always low



ATTENTION! When you access the pellet recipe menu, a POP-UP appears prompting a password. Enter "1234"-

To edit the **PELLET** recipe, select one of the values available.

The available values are:

- 3 = Reduction of pellet loading by 20% at all power values
- 2 = Reduction of pellet loading by 13% at all power values
- 1 = Reduction of pellet loading by 6% at all power values
- 0 = no change
- 1 = Increase of pellet loading by 3% at all power values
- 2 = Increase of pellet loading by 6% at all power values
- 3 = Increase of pellet loading by 10% at all power values

To edit the **AIR recipe**, select one of the values available.

The available values are:

- 2 = - 10%
- 1 = - 5%
- 0 = (default value)
- 1 = + 5%
- 2 = + 10%

This function is used to adjust combustion air if the flame is too high or too low.

ADAPTIVE MODE

This function is found in the "pellet recipe" menu.

By activating the function (select ON) the stove adapts its operation in case of special installations or when using poor quality pellets.

The following are some examples of when it is recommended to activate the function:

- formation of combustion residue
- formation of condensate in the flue when operating at minimum power
- improve cleaning of the glass when operating at minimum power



Attention! It is preferable that this mode ("Pellet recipe"/"Adaptive mode") be activated under the supervision of a qualified technician.

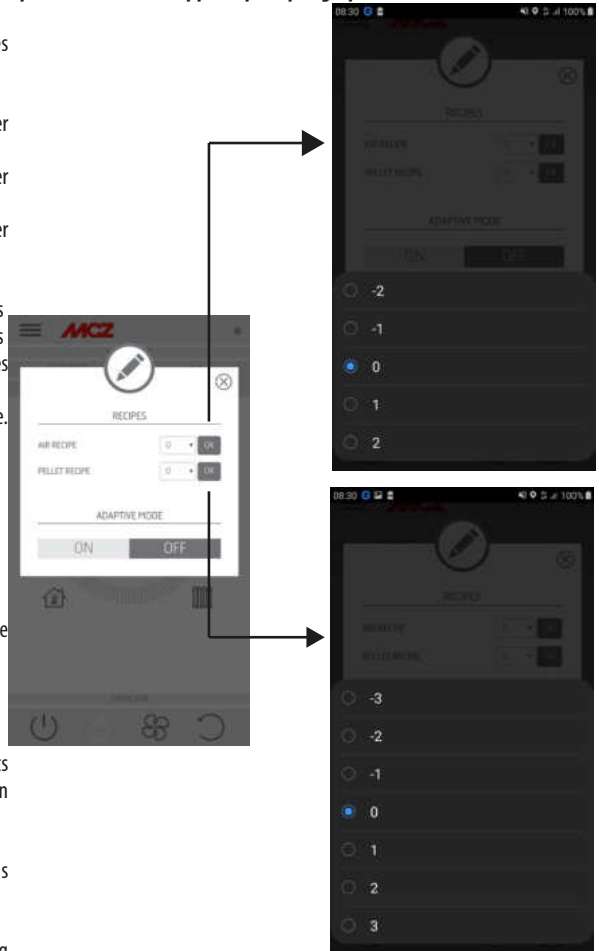

23-SETTINGS MENU

SUMMER/WINTER

Option to select the operating season.

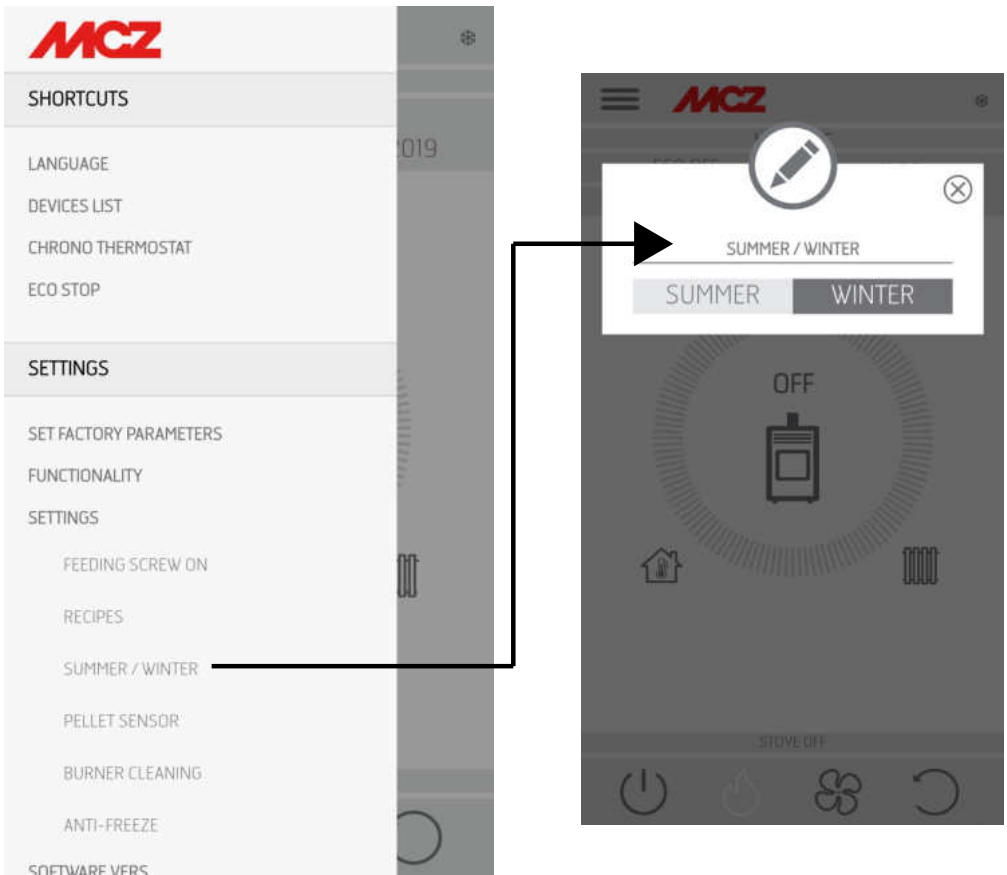

23-SETTINGS MENU

PELLET SENSOR

The pellet sensor is used to measure the level of pellets in the hopper. It can be activated from the side menu, SETTINGS after having assembled the sensor on the hopper and carried out the appropriate connection in the card (see next page).

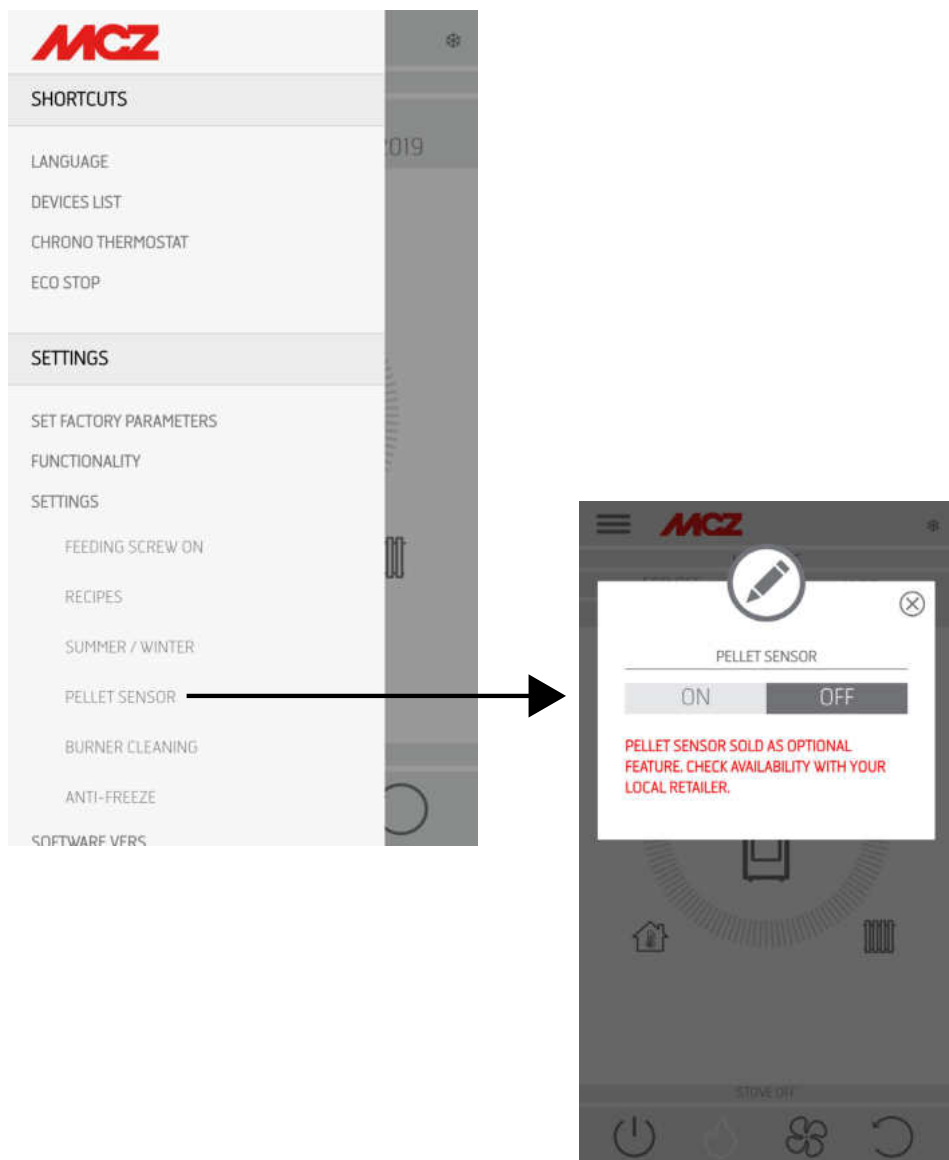

23-SETTINGS MENU

ASSEMBLING PELLET LEVEL SENSOR

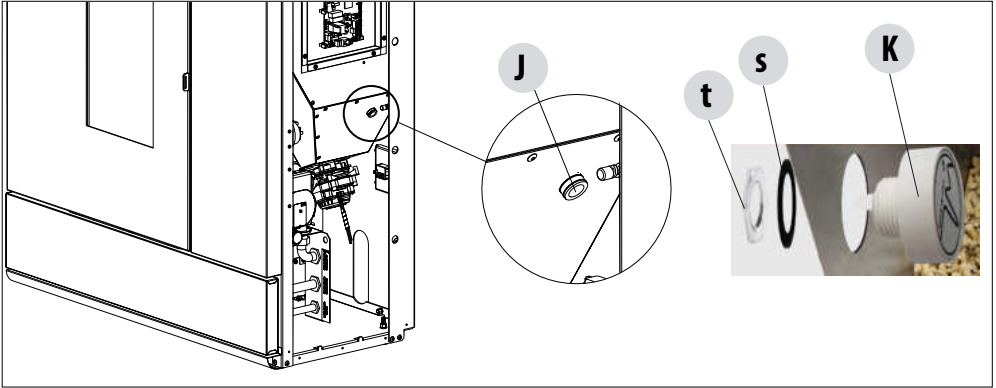

The pellet sensor is a low fuel indicator that warns the user that the pellets are finishing. With the hopper empty, lift the pellet loading cover and manually remove the cap "J" fitted inside, then insert the pellet level sensor "K" from inside the hopper.

The sensor is locked to the tank by externally mounting the seal "s" and firmly securing it with the ring nut "t".

The sensor must then be connected to position 22 on the circuit board with the cable supplied.

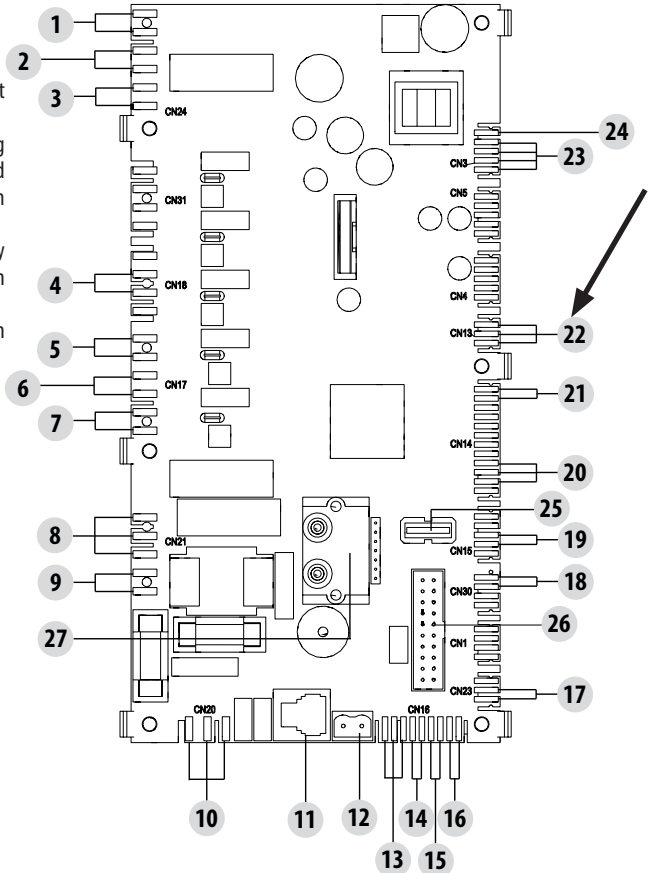

23-SETTINGS MENU

BRAZIER CLEANING

Only for "MATIC" products with automatic brazier cleaning system.
Press "ENABLE" to set a complete cleaning cycle for the product.

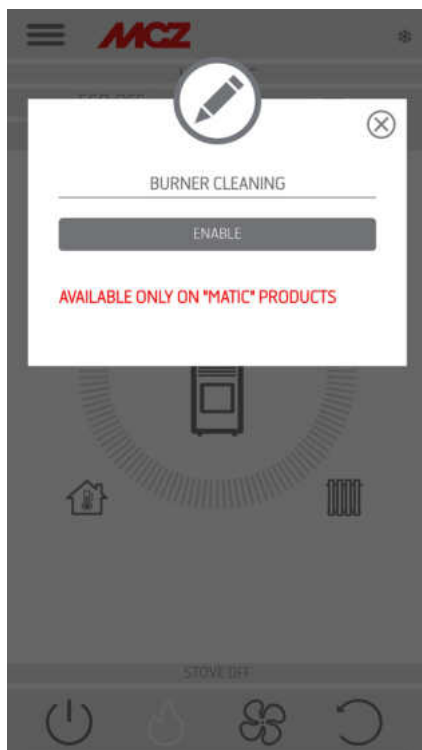

23-SETTINGS MENU

ANTI-FREEZE

When the water temperature drops below 5 °C, with ICE function enabled, the circulator switches on.



24-SOFTWARE VERSION

SOFTWARE VERSION

The SOFTWARE VERSION option is found in the SETTINGS menu. Through this item it is possible to know all the stove information e.g. Database and app version.

The values displayed in the figure are purely indicative.

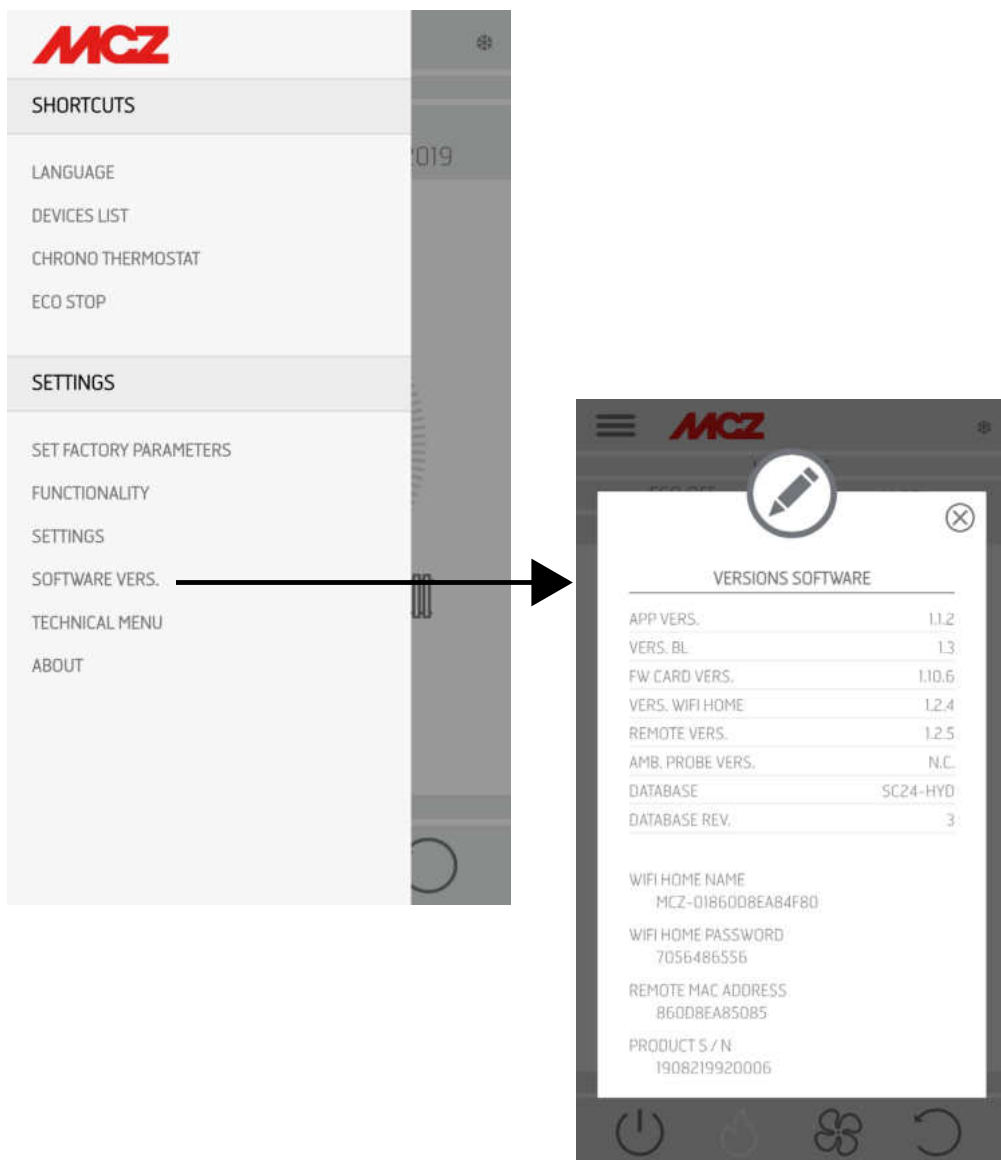

25-TECHNICAL MENU

TECHNICAL MENU



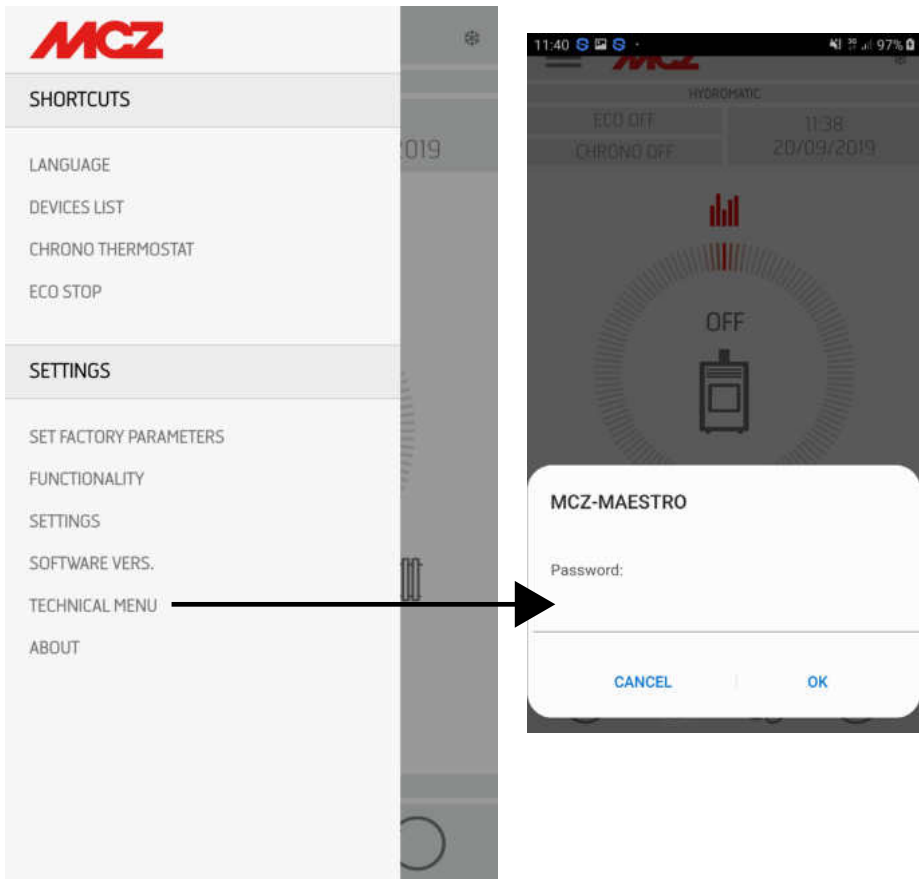





To enter the TECHNICAL MENU, select the three dashes at the top, scroll to the end of the drop-down menu and select the item. To enter the functions it is necessary to enter a Password (available for authorised technicians) and press OK.



24-SOFTWARE VERSION

The main functions that can be changed and/or controlled from the technical menu are:



PARAMETERS		• PARAMETERS
ACTIVE ON / OFF		• ACTIVE ON/OFF
SYSTEM T°		• SYSTEM T°
DIAGNOSTICS		• DIAGNOSTICS
SELECT DATABASE		• SELECT DATABASE
FACTORY DATA RESET		• FACTORY RESET
SERVICE HOURS RESET		• SERVICE RESET
LAST ALARMS		• LAST ALARMS
WORKING HOURS		• WORKING HOURS



26-INFO MENU

INFO

The INFO menu provides certain information regarding the stove's status

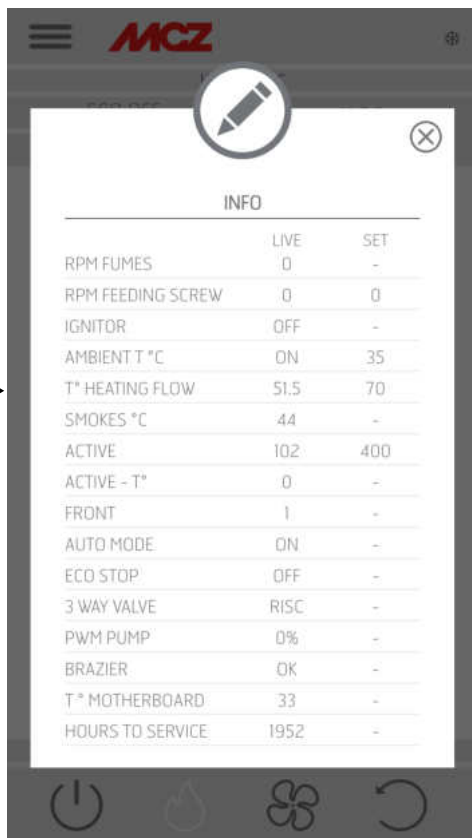
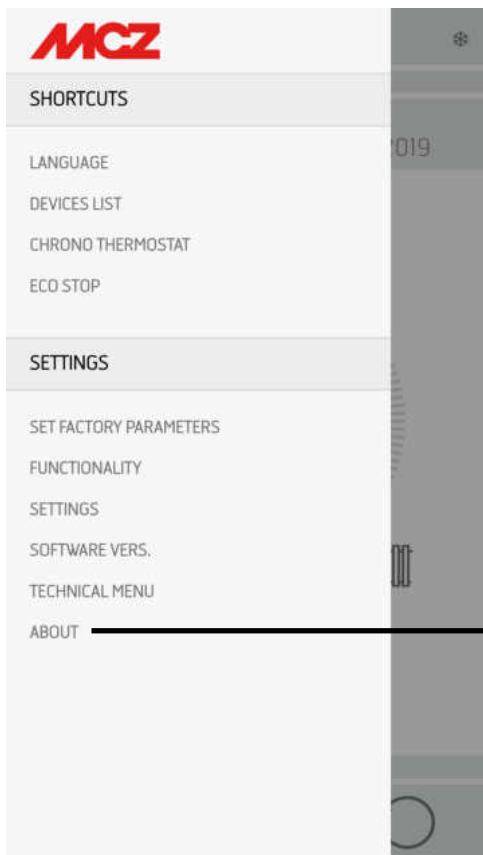

26-INFO MENU

- **Puffer thermostat**

To activate this option, connect a Normally Open (N.O.) contact thermostat to points 1 and 2 of the back 12-pole terminal board. Even with this configuration the purpose of the room probe on the stove is only to control the heating system pump controlled by the potential free contact on terminals 7-8-9, if the system pump is activated in Aux out mode.

Connections table

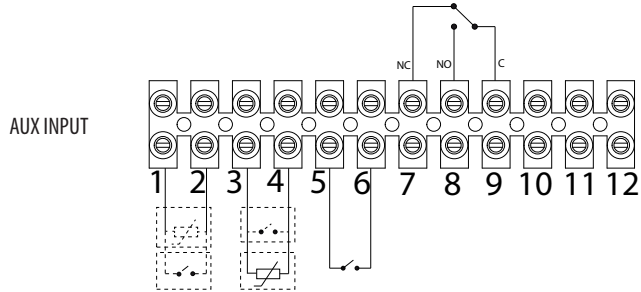

TERMINAL NO.	NAME ON BOARD	FUNCTION
1-2	NTC2	LOW PUFFER PROBE - PUFFER THERMOSTAT
3-4	NTC1	ROOM PROBE - ROOM THERMOSTAT
5-6	NTC3	STORAGE TANK PROBE - STORAGE TANK THERMOSTAT- HIGH PUFFER PROBE
7-8-9	AUX RELAY (Potential-free-contact -Maximum contact voltage - 24V AC/DC)	7 - NORMALLY CLOSED 8 - NORMALLY OPEN 9 - COMMON
10-11-12	3-WAY RELAY (Mains voltage contacts)	POS.10 - DHW (F) POS.11 - COMMON (N) POS.12 - HEATING (F)

To access terminal block "M" remove the right panel, as indicated in part 1 of the manual (in the paragraph devoted to the removal of the back panel). Perform the necessary connections and place everything back.

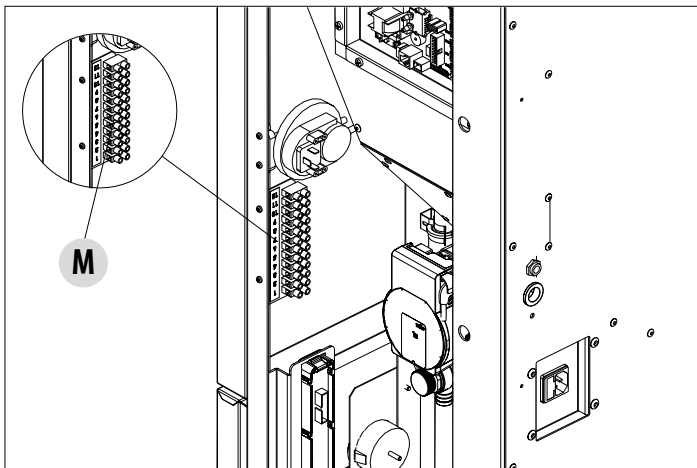

26-INFO MENU

AIR STOVE PRINCIPLE DIAGRAMS



The following diagrams are to be used only as a guideline. For proper connection, always follow the notes of the plumbing and heating installer. The plumbing system must meet local, regional, or national regulations in force. Installation and verification of operation is to be performed only by specialised, authorised personnel. The manufacturer will not be held liable for non-compliance with the provisions listed above.

HEATING ONLY CONFIGURATION

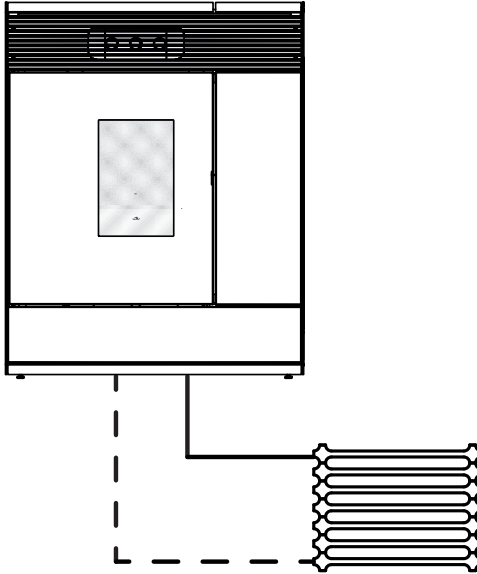

STORAGE CYLINDER CONFIGURATION

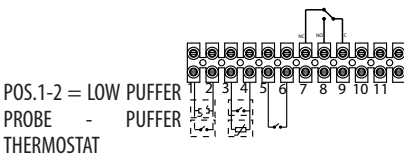

POS.10-11-12
= THREE-WAY VALVE

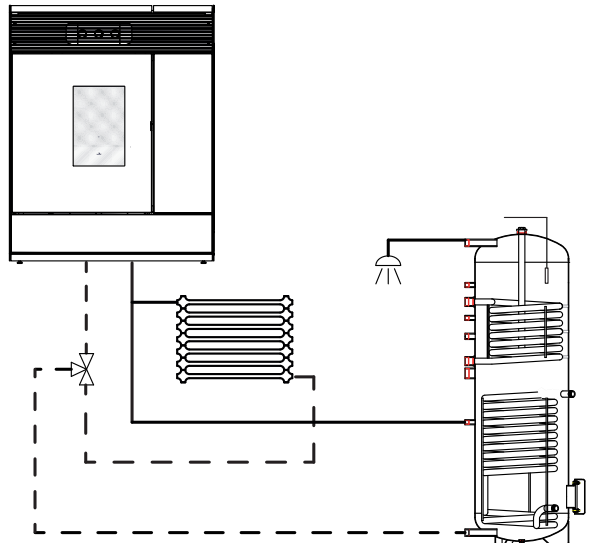

26-INFO MENU

HYDROMATIC STOVE WITH PUFFER CONFIGURATION

POS.1-2 = LOW PUFFER PROBE -
PUFFER THERMOSTAT

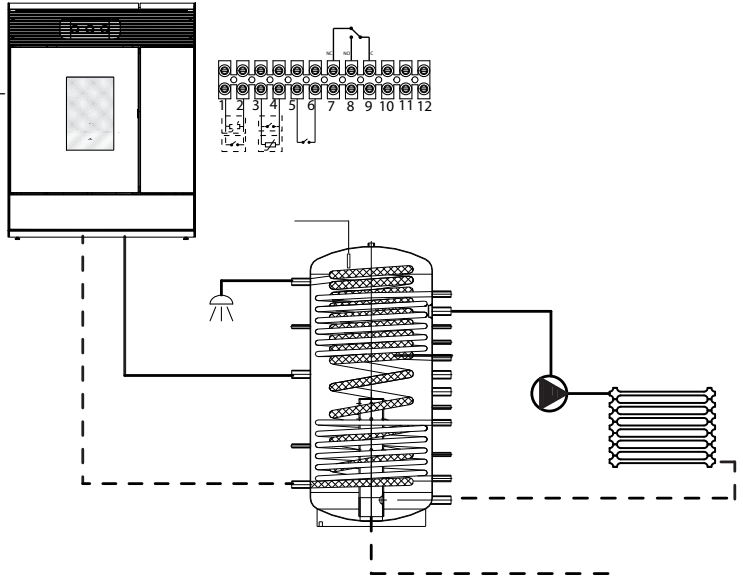

27-SAFETY DEVICES AND ALARMS

SAFETY DEVICES

The product is fitted with the following safety devices

ACTIVE +

Besides adjusting the stove operation, it also guarantees that the pellet loading feed screw is blocked if unloading is blocked or there is significant back pressure.

SMOKE TEMPERATURE PROBE

Detects the temperature of the smoke, thereby enabling start-up or stopping the product when the temperature drops below the preset value.

CONTACT THERMOSTAT IN THE FUEL TANK

If the temperature exceeds the preset safety level, it immediately shuts down the stove.

WATER THERMOSTAT

If the temperature exceeds the preset safety level, it immediately shuts down the stove.

WATER TEMPERATURE SENSOR

When the water reaches the stop temperature (85°C), the probe automatically instructs the stove to carry out automatic "OFF Stand-by" shut-off.

ELECTRICAL SAFETY

The stove is protected against violent changes in current by a general fuse located in the control panel at the back of the stove. Other fuses that protect the circuit boards are located on the said boards.

SMOKE FAN

If the fan stops, the circuit board immediately shuts off the supply of pellets and an alarm message is displayed.

GEAR MOTOR

If the gear motor stops, the stove will continue to run until the flame goes out due to lack of fuel and until a minimum level of cooling is reached.

TEMPORARY POWER CUT

When a power cut is less than 10", the stove returns to its previous operating state; if it is more, it executes a cooling/re-ignition cycle.

FAILED START-UP

If during ignition no flame develops, the stove will go into alarm condition.

ANTI-FREEZE FUNCTION

If the probe in the stove detects a water temperature lower than the set value, the circulation pump is automatically activated to keep the system from freezing.

PUMP ANTI-SEIZURE FUNCTION

If the pump is not used for prolonged periods, it is activated periodically for a few seconds to keep it from seizing up.

27-SAFETY DEVICES AND ALARMS



TAMPERING WITH THE SAFETY DEVICES IS PROHIBITED

If the stove is NOT used as described in this instruction manual, the manufacturer declines all responsibility for damage to persons and property that may arise. The manufacturer furthermore denies any liability for damage to persons and property arising from failure to observe all the rules contained in the manual and specifically:

- *All the necessary measures and/or precautions must be adopted when performing maintenance, cleaning and repairs.*
- *Do not tamper with the safety devices.*
- *Do not remove the safety devices.*
- *Connect the stove to an efficient smoke expulsion system.*
- *First, check that the environment where it is to be installed is properly ventilated.*



Only after eliminating the cause of the intervention of the safety system is it possible to re-ignite the stove and thus restore the probe's automatic operation. This manual will help you understand which anomaly has occurred, and explain how to intervene according to the alarm message displayed on the stove.

27-SAFETY DEVICES AND ALARMS

ALARM SIGNALLING

If an operating anomaly occurs the stove starts switching off due to the alarm. The type of alarm appears on the App. The app signals the active alarm codes while a red LED lights up on the stove panel.

The following table describes the possible alarms indicated by the stove, associated to the respective code that appears on the emergency panel and helpful tips to solve the problem.

WRITTEN ON THE DISPLAY	TYPE OF PROBLEM	SOLUTION
A01 NO IGNITION	The fire does not ignite. (without acoustic alarm)	Check the level of pellets in the hopper. Check that the brazier is correctly positioned in its seat and has no deposits or unburnt material. Make sure the glow plug warms up. Thoroughly empty and clean the brazier before restarting.
A02 NO FLAME	The fire goes out abnormally. (without acoustic alarm)	Check the level of pellets in the hopper. Check that the brazier rests correctly in its seat and has no visible deposits of unburnt pellets.
A03 SAFETY PLT (SIC1)	Pellet hopper temperature too high	The structure is too hot because the product has been used for too long at the maximum power or there is poor ventilation. When the stove is sufficiently cold, clear the alarm on the stove panel or via app. Once the alarm is cancelled, the product can be switched on normally.
A04 SMOKE TEMP	The temperature of the exhaust smoke has exceeded certain preset safety limits.	The stove switches off automatically. Let the stove cool down for a few minutes and then switch it on again. Check the smoke expulsion and verify the type of pellet used according to the instructions found in Chap. 2 of this manual. If the alarm persists, contact the service centre.
A05 OBSTRUCTION	Flue clogged - wind.	Check the smoke duct.
	The smoke extractor fails to guarantee sufficient primary air, required for correct combustion.	Draught difficulties or clogged brazier. Check whether the brazier is clogged and clean it, if necessary. Check, and if necessary clean, the smoke duct and the air inlet.
A08 SMOKE FAN	Abnormal operation of smoke fan	Check cleanliness of the smoke fan compartment and check if dirt is blocking it. If this is not enough, the smoke fan is faulty. Contact an authorised service centre to have it replaced.

27-SAFETY DEVICES AND ALARMS

WRITTEN ON THE DISPLAY	TYPE OF PROBLEM	SOLUTION
A09 SMOKE PROBE	The smoke probe is faulty and does not detect the exhaust smoke temperature properly.	Contact an authorised service centre to have the component replaced.
A11 GEAR MOTOR	Feed screw gear motor fault.	The component is not working regularly. Contact an authorised service centre to have the component checked and, if needed, replace the component.
A12	Faulty gear motor driving sensor (PWM)	Contact an authorised service centre.
A13 BOARD TEMP	Circuit board overheating	The structure is too hot because the product has been used for too long at the maximum power or there is poor ventilation. When the stove is sufficiently cold, clear the alarm on the stove panel or via app. Once the alarm is cancelled, the product can be switched on normally.
A14 ACTIVE SENSOR	Active sensor anomaly	Active Plus sensor operation anomaly. This alarm blocks the stove and can be reset from the App. If the sensor is faulty, the alarm appears once again. Contact an authorised service centre to have the component replaced.
A17	Blocked feed screw due to clogged pellets or a foreign body	The feed screw is not unblocked even after the feed screw unblocking procedure indicated by the software has been carried out (rotating the gear motor in both directions). Try to remove the pellets and/or foreign body with an extractor or call an authorised service centre to perform this operation.
A18 SAFETY DEVICES WATER THERMOSTAT (SIC2)	Tripped safety devices	Water temperature is too high or thermostat operation anomaly. Water pressure too low. Triggered air pressure switch: check the pressure of the hydraulic system. Make sure the pellet tank and door are closed. If the alarm persists, contact the service centre.
A19 WATER PROBE	Water probe failure	Possible fault in the safety component. Contact an authorised service centre to have the component checked and, if needed, replace the component.

27-SAFETY DEVICES AND ALARMS

WRITTEN ON THE DISPLAY	TYPE OF PROBLEM	SOLUTION
A20 AUX PROBE	Auxiliary probe failure	Possible component fault. Check that the probe inserted in the system respects the characteristics specified in the instructions (see external probe). Contact an authorised service centre to have the component checked and, if needed, replace the component.
A21 PRESSURE SWITCH-ES (SIC3)	Open stove door	Close the door
	Open fuel loading hatch	Close the hatch. Lower the fuel level in the hopper.
	Air pressure switch	Draught difficulties or clogged brazier. Check whether the brazier is clogged by deposits and clean it, if necessary. Check and if necessary clean the smoke duct and air inlet.
A22	Room probe failure	Possible fault in the safety component. Contact an authorised service centre to have the component checked and, if needed, replace the component.
A23	Brazier not closed	Possible obstruction in the brazier. Clean. If the problem persists, contact a service centre.

Exiting the alarm conditions



NEVER open the stove door whilst it is either in the initial ignition or on its shut down cycle, pellets will still be smouldering or therefore volatiles may be present.

ATTENTION!

If during operation or initial ignition you encounter combustion smoke leakage into the room from the appliance or the flue, then please switch off the appliance, ventilate the room and contact the installation / service technician immediately.

When the stove enters an alarm state, an automatic cooling/shut-off phase begins, at the end of which the cause of the alarm is displayed on the small panel.

Follow the procedure described below to restore normal stove operation after an alarm has been triggered:

- Cancel alarms A01, A02, A03, A05, A21 only from the panel on the stove.
- Cancel the other alarms from the App.

If the indicated actions do not solve the problem, the alarm condition will occur once again with different timing based on the alarm type: in this case, contact technical assistance.

27-SAFETY DEVICES AND ALARMS

SHUTDOWN

If the shut-down key is pressed or one of the following conditions occurs:

- power request ends (Power = 0) for Ecstop, Timer, Sleep
- an alarm condition occurs
- water overheating occurs

the stove enters the shutdown and thermal cooling phase that automatically includes the execution of the following phases:

- pellet loading stops
- the room fan maintains the set speed until it cools down
- the smoke extractor is activated at maximum speed and remains on for a fixed period of 15 minutes, at the end of which the stove off temperature is reached.
- The brazier is cleaned mechanically at the end of the cooling process

During the shutdown phase, the small panel displays the wording OFF (see screen) but if it is in shut down due to an alarm condition, the small panel displays the related code (See alarms table)

BLACKOUT WITH STOVE ON

If power is lost for less than 10" from stove start-up, it is repositioned in the phase where it was before the power failure.

If the loss of power exceeds 10", when the stove is powered once again, it goes back to the previous operational condition with the following procedure it

- carries out a cooling phase, during which the panel displays OFF BLACKOUT
- restarts the stove

If the stove is in ignition phase when the blackout occurs, it will not turn back on once the power is restored (there is a risk that residual pellet is present in the brazier) and the panel will display OFF BLACK-OUT.

If the ON key is pressed during the cooling phase, the stove stops executing the blackout restore state and it proceeds with ignition as requested by the command. In the same way, pressing OFF is interpreted as a shut off command.

28-RECOMMENDATIONS FOR SAFE USE



ONLY CORRECT INSTALLATION AND APPROPRIATE MAINTENANCE AND CLEANING OF THE APPLIANCE CAN GUARANTEE CORRECT OPERATION AND SAFE USE OF THE PRODUCT

We would like to inform you that we are aware of cases of malfunctioning of domestic pellet-fuelled heating products, mainly due to incorrect installation and inappropriate maintenance.

We would like to assure you that all of our products are extremely safe and certified according to European standards of reference. The ignition system has been tested with the utmost attention to enhance ignition efficiency and to prevent any type of problem, even in the worst operating conditions. In any case, as with any other pellet-fuelled product, our appliances must be installed correctly and undergo regular periodical cleaning and maintenance to guarantee safe operation. Our studies show us that malfunctioning is mainly due to the combination of part or all of the following factors:

- Brazier holes obstructed or brazier deformed, due to lack of maintenance and conditions which can cause delayed ignition, generating an anomalous production of unburnt gases.
- Insufficient combustion air due to a reduced or clogged air inlet duct.
- Use of smoke ducts nonconforming to regulatory installation requirements, failing to guarantee an adequate draught.
- Partially clogged chimney, due to lack of maintenance, reducing the draught and making ignition difficult.
- End chimney pot not conforming to the indications of the instruction manual, and therefore not suitable to prevent potential inverse draught.
- This factor is crucial when the product is installed in especially windy areas, such as coastal regions.

The combination of one or more of these factors may generate severe malfunctioning conditions.

To keep this from occurring, it is crucial to guarantee that the product is installed in compliance with standards in force.

Furthermore it is of the utmost importance to comply with the following simple rules:

- Every time the brazier is removed for cleaning, it must always be put back properly in the work position before using the product, completely removing any residual dirt left on the support base
- Pellets must never be loaded in the brazier manually, neither before ignition or during operation.
- The build-up of unburnt pellets following failed ignition must be removed before repeating ignition. Also check that the combustion air inlet/smoke outlet is fitted correctly in place and working properly.
- If ignition fails repeatedly, immediately suspend use of the product and contact a qualified technician to check its operation.

Compliance with these indications is absolutely sufficient to ensure proper operation and to avoid any type of problems with the product.

If the aforementioned precautions are not taken, and during ignition the brazier is overloaded with pellets thus generating anomalous smoke in the combustion chamber, carefully follow the indications below:

- Do not disconnect the electrical power to the product for any reason whatsoever: this would stop the smoke extractor, releasing smoke into the room.
- Take the precaution of opening the windows to ventilate the installation room from any smoke (the chimney might not be working properly)
- Do not open the fire door: this would compromise regular operation of the smoke extraction system to the chimney.
- Simply switch the stove off by operating on the on-off button on the control panel (not the rear power supply socket button!) and move away until the smoke has been completely extracted.
- Before attempting re-ignition, clean the brazier and its air passage holes completely of all deposits and unburnt pellets. Put the brazier back in place, removing any residue from its support base. If ignition fails repeatedly, immediately suspend use of the product and contact a qualified technician to check its operation and the chimney.

29-CLEANING AND MAINTENANCE

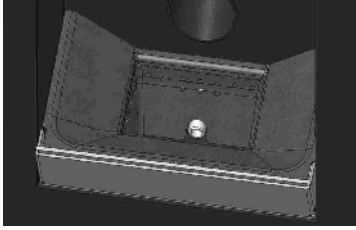

EXAMPLE OF A CLEAN BRAZIER



EXAMPLE OF A DIRTY BRAZIER

Only by properly servicing and cleaning the product is it possible to ensure its safety and correct operation.



ATTENTION!

All the cleaning operations of all parts must be performed with the product completely cold and unplugged. Disconnect the product from the 230V power supply before performing any maintenance operations.

The product requires little maintenance if used with certified good quality pellets.

DAILY OR WEEKLY CLEANING PERFORMED BY THE USER

Ash pan cleaning

Open the lower door "R". Turn the handle of door "G" to the right and open it by moving it downwards.

Remove and empty ash pan "D". Wipe away any residual ash before reinserting the pan. Your experience and the quality of the pellets will determine the ash pan cleaning frequency. However, it is recommended not to exceed 2 or 3 days.

When cleaning the ash pan, we recommend removing piece "C" near the brazier and use the nozzle of the vacuum cleaner to remove any ash deposits.

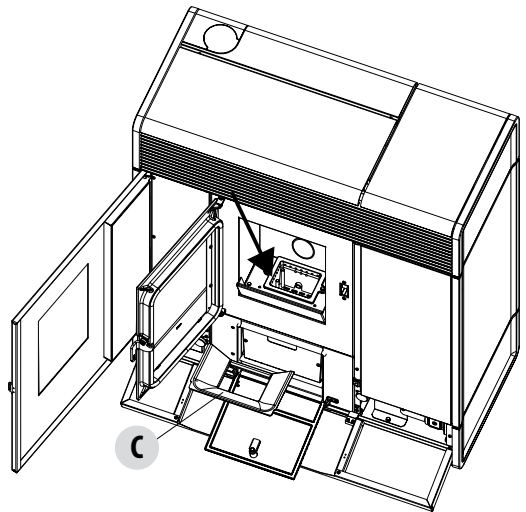
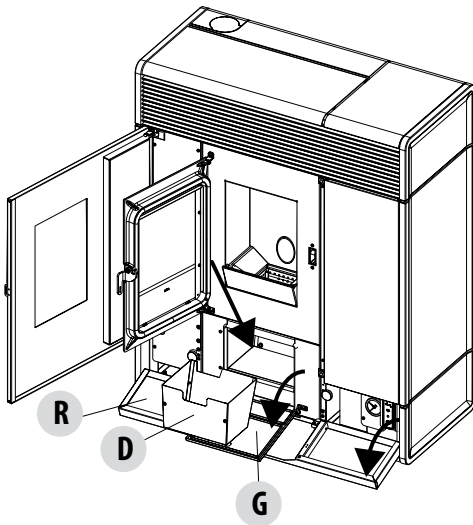

CLEANING THE GLASS

It is recommended to clean the ceramic glass with a dry brush, or if it is very dirty, spray with a little specific detergent and clean with a cloth.



ATTENTION!

Do not use abrasive products and do not spray the glass cleaning product on the painted parts and on the door gaskets (ceramic fibre seal).

29-CLEANING AND MAINTENANCE

CLEAN THE HEAT EXCHANGER AND THE COMPARTMENT BENEATH THE BRAZIER EVERY 2/3 DAYS

Cleaning the heat exchanger and the compartment beneath the brazier is a simple operation but very important if the boiler is to maintain optimal performance.

- **Clean the pipe unit** - Using handle "A" located under the tank cover, vigorously shake the turbulators 5-6 times. This will remove any soot that has deposited on the exchanger's smoke ducts during normal stove operation.

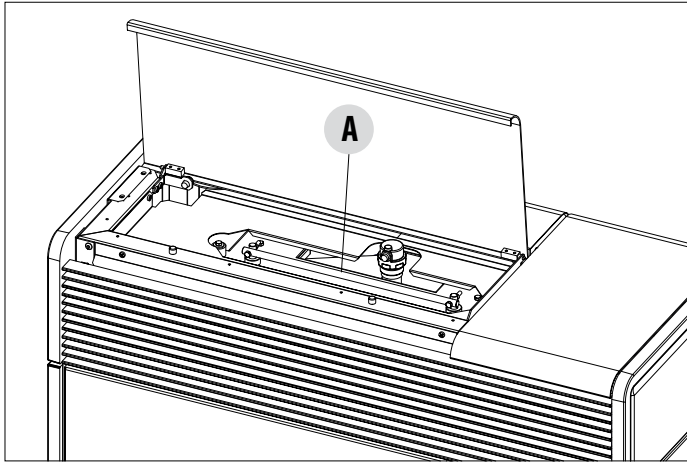

- **Enable "CLEANING" function** Then activate the cleaning function, proceeding as follows:
 - select "SETTINGS" menu, brazier cleaning, activate the function. This procedure activates opening of the brazier and the smoke extractor at maximum power to expel the soot that becomes dislodged when the heat exchanger is cleaned.

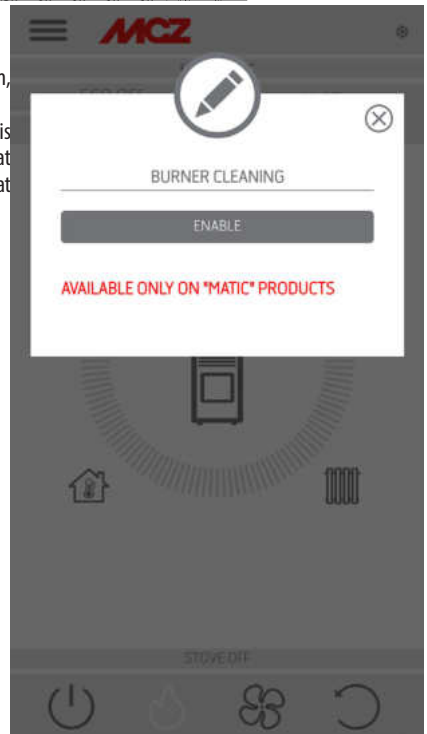

BRAZIER CLEANING

Only for "MATIC" products with automatic brazier cleaning system. Press "ENABLE" to set a complete cleaning cycle for the product.

29-CLEANING AND MAINTENANCE

- Clean the smoke extractor compartment (see explanation on next page)

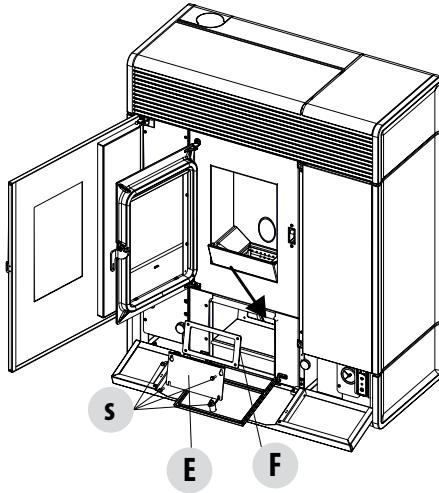

- The stove is equipped with a removable ash pan "D" which collects soot and ash.
- Carefully clean the lower compartment, see arrow (bottom of pan)

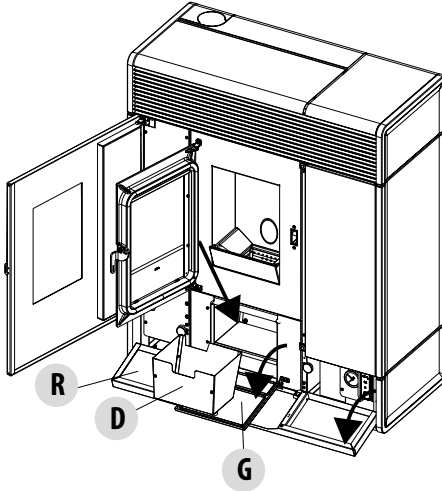

- When cleaning is finished, refit all the removed parts.



If cleaning is not done every 2-3 days, the stove could go into alarm conditions due to ash clogging.

29-CLEANING AND MAINTENANCE

CLEANING THE PIPE UNITS

For better performance of the boiler, the pipes inside the combustion chamber should be cleaned once a month.

Open the firebox door and use the brush provided to clean the 5 pipes positioned at the top inside the combustion chamber. Brush the pipes several times so that the ash deposited inside them falls to the bottom around the brazier.

Use a vacuum cleaner to remove all fallen material.

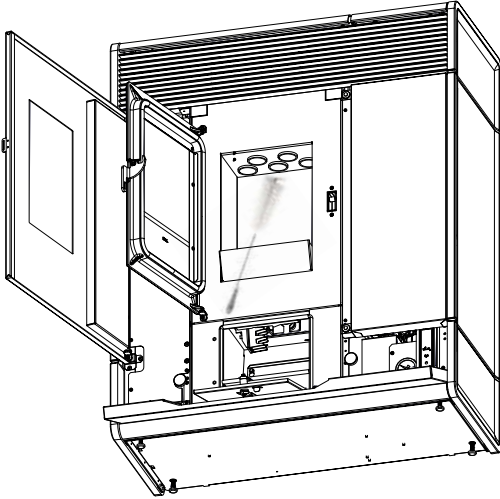

CLEANING THE SMOKE EXTRACTOR COMPARTMENT

In the area behind ash pan "D", there is the smoke cap "E", which must be removed to clean the smoke extractor. Therefore:

- loosen the screws "S"
- remove cap "E"

Now, use the nozzle of a vacuum cleaner, remove any ash and soot that may have built up in the lower exchanger indicated by the arrow.

Before putting cap "E" back, we recommend changing gasket "F"

Before removing ash using a vacuum cleaner, it is recommended to clean the internal walls of the stove using the supplied scraper.

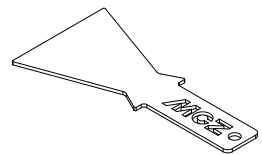
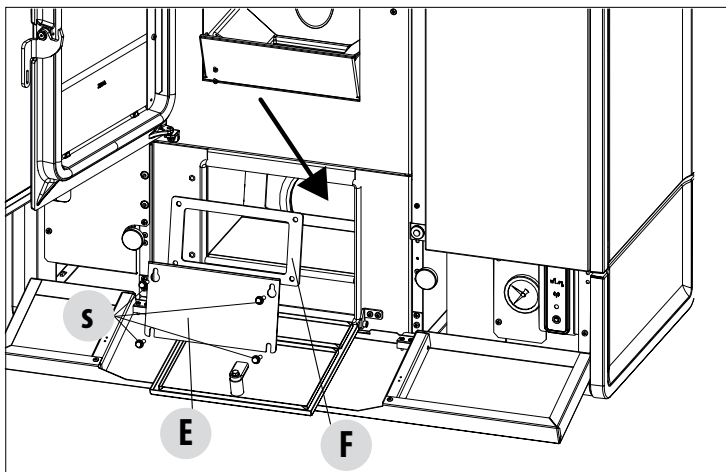

SCRAPER

LOWER COMPARTMENT
CLEANING

29-CLEANING AND MAINTENANCE

CLEANING THE SMOKE EXPULSION SYSTEM AND GENERAL CHECKS

Clean the smoke outlet system, especially around the Tee fittings, elbows and any horizontal sections of the smoke duct. For information on periodically cleaning the flue, contact a skilled chimney sweep.

Check the seal of the ceramic fibre gaskets on the door of the stove. If necessary, order new replacement gaskets from the retailer or contact an authorised service centre to carry out the operation.



ATTENTION:

The frequency with which the smoke outlet system is cleaned depends on the use of the stove and the type of installation.

We recommend relying on an authorised service centre for end-of-season cleaning and maintenance, as they will carry out all of the previously mentioned work and inspect the stove components.

PERIODICAL CHECK OF THE DOOR CLOSURE

Make sure the door closure ensures a correct sealing action (with the "paper sheet" test) and that when the door is closed, the closing block (X in the figure) does not protrude from the sheet metal to which it is secured. For some products it will be necessary to disassemble the cladding to be able to assess the anomalous protrusion of the block when the door is closed.

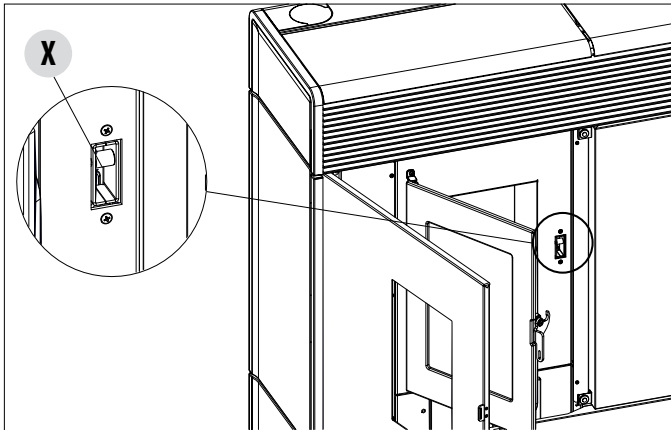

SHUTDOWN (end of season)

At the end of each season, before switching the product off, it is recommended to remove all the pellets from the hopper with a vacuum cleaner with a long pipe.

We recommend removing the unused pellets from the hopper because they can retain moisture. Disconnect any combustion air ducting that can lead to moisture inside the combustion chamber but, above all, ask the specialised technician to refresh the paint inside the combustion chamber with the special silicone spray paints (available at any store or Technical Assistance Centre) during the necessary annual end of season scheduled maintenance operations. This way the paint will protect the inner parts of the combustion chamber, blocking any type of oxidative process.

When not in use the appliance must be disconnected from the mains power supply. It is recommended to remove the power cable for additional safety, especially in the presence of children.

The service fuse may have to be replaced if the control panel display does not switch on when the product is switched on again by pressing the main switch on its side.

There is a fuse compartment on the back of the product, under the power socket. After having disconnected the plug from the socket, use a screwdriver to open the cover of the fuse compartment and, if necessary, replace them (3.15 A delayed).

29-CLEANING AND MAINTENANCE

REPLACING THE OVERPRESSURE DISCHARGE FOR THE COMBUSTION CHAMBER

Overpressure rubber bushing "G" of the combustion chamber (fig. A) may get worn and/or damaged, it is therefore necessary to replace it once a year to ensure correct system operation.

To replace it, follow the instructions below

- Remove the top
- Remove the first ceramic panel of the side cladding or the steel panel (depending on the type of stove)
- Unscrew the screw-washer-rubber bushing-roller shown in figure A/C (on both sides of the cover). It is now possible to assemble the new kit:
- Prepare the screw-washer-rubber bushing-roller aligned as shown in fig. C and screw them into the structure.
- Tighten the screw all the way.

Now ensure that the compression of the rubber bushing is correct using the template supplied with the kit:

- Place the template on the cover (fig. B); the head of the screw must be touching the element above it. If necessary, tighten or loosen the screw so that it is touching the upper element.

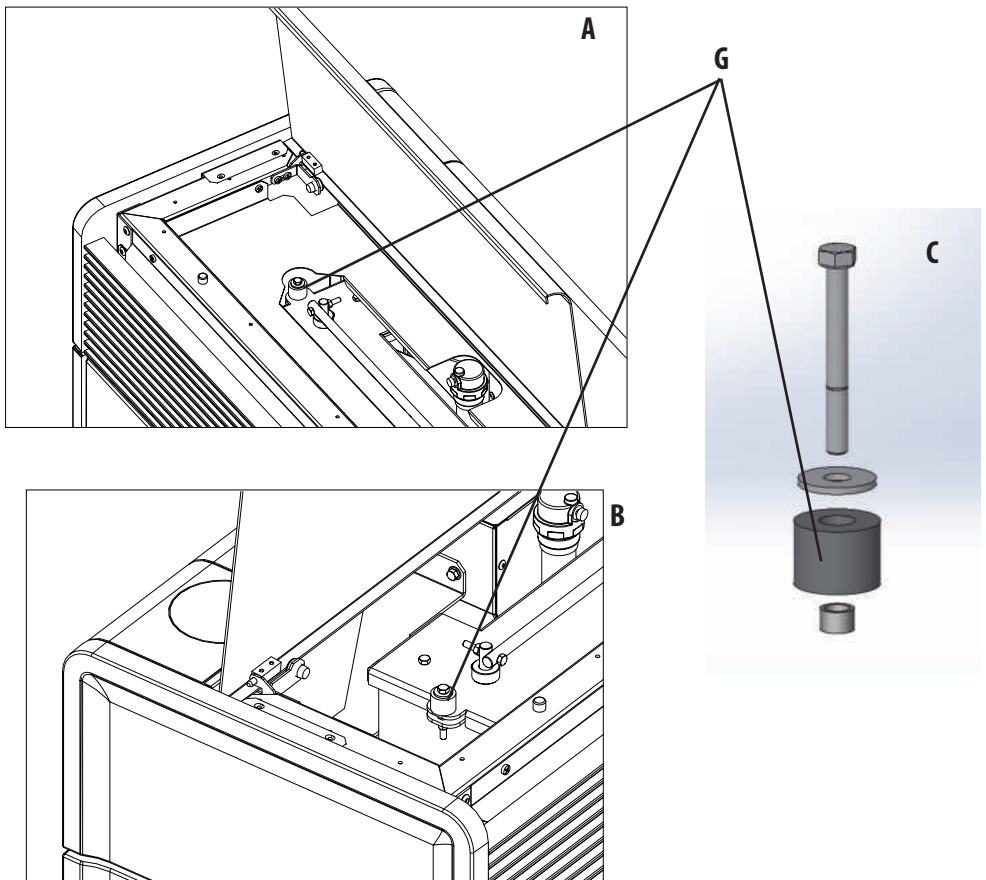

29-CLEANING AND MAINTENANCE

CHECKING THE INTERNAL COMPONENTS



ATTENTION!

The internal electromechanical components must only be checked by qualified personnel whose technical expertise includes combustion and electricity.

We recommend for this yearly maintenance to be carried out (with a scheduled service contract). This operation consists of a visual and functional inspection of the internal components. A summary of the checks and/or maintenance operations that are essential for the correct operation of the product is provided below.

	PARTS/FREQUENCY	2-3 DAYS	7 DAYS	1 YEAR
UNDER THE USER'S RESPONSIBILITY	Brazier area		•	
	Ash pan		•	
	Glass	•		
	Lower compartment		•	
	Turbulators		•	
BY THE QUALIFIED TECHNICIAN	Complete heat exchanger			•
	Smoke duct			•
	Door gasket			•
	Internal parts			•
	Flue			•
	Circulation pump			•
	Plate heat exchanger			•
	Plumbing components			•
	Electro-mechanical components			•
	Overpressure silicon damper for combustion chamber			•
	Door closure operation			•

CLEANING THE CONTROL PANEL DISPLAY



ATTENTION!!

THE PANEL DISPLAY IS VERY DELICATE, IT IS SUPPLIED WITH A PROTECTIVE FILM.

RECOMMENDATIONS FOR CLEANING:

Clean using a soft cotton cloth, which should be dry or slightly moist.

Do not use aggressive detergents or polyester materials.

Do not use abrasive sponges or powder detergents nor solvents such as alcohol and petrol, since they may damage the surface of the device.

30-TROUBLESHOOTING



ATTENTION:

All repairs must be carried out exclusively by a specialised technician, while the stove is completely cold and the electric plug is disconnected.

ANOMALY	POTENTIAL CAUSES	SOLUTIONS
The pellets are not fed into the combustion chamber	The pellet hopper is empty	Fill the tank with pellets
	Sawdust has blocked the feed screw	Empty the tank and remove the sawdust from the feed screw by hand
	Faulty gear motor	Replace the gear motor
	Faulty electronic board	Replace the circuit board
The fire goes out or the stove stops automatically	The pellet hopper is empty	Fill the tank with pellets
	The pellets are not fed	See the previous anomaly
	The pellet temperature safety probe has been triggered	Let the stove cool down, reset the thermostat until the problem is resolved and switch the stove back on. If the problem persists, contact technical assistance
	Chrono active	Check if the chrono setting is active
	The door is not closed properly or the gaskets are worn	Close the door and replace the gaskets with original ones
	Unsuitable pellets	Change the type of pellets with those recommended by the manufacturer
	Low pellet supply	Check the flow of fuel following the instructions in the booklet
	The combustion chamber is dirty	Clean the combustion chamber, following the instructions in the booklet
	Clogged outlet	Clean the smoke duct
	Faulty smoke extraction motor	Check the motor and replace it, if necessary
Water tank temperature too high	Check correct operation of the water circulation pump and the hydraulic system in general.	

30-TROUBLESHOOTING

ANOMALY	POTENTIAL CAUSES	SOLUTIONS
The stove runs for a few minutes and then goes out	Ignition stage not completed	Repeat ignition
	Temporary power cut	Wait for the automatic restart
	Clogged smoke duct	Clean the smoke duct
	Faulty or malfunctioning temperature probes	Check and replace the probes
Pellets accumulate in the brazier, the glass of the door gets dirty and the flame is weak	Insufficient combustion air	Make sure that the air inlet in the room is fitted and clear. Check that the combustion air filter on the Ø 5 cm air inlet pipe is not clogged. Clean the brazier and check that all the holes are clear. Perform a general cleaning of the combustion chamber and the smoke duct. Check the condition of the door gaskets
	Damp or unsuitable pellets	Change the type of pellets
	Faulty smoke evacuation motor	Check the motor and replace it, if necessary
The smoke evacuation motor does not work	No electrical supply to the stove	Check the mains voltage and the protection fuse
	Motor block caused by clogging.	Perform a general cleaning of the combustion chamber and the smoke duct.
	The motor is faulty	Check the motor and capacitor and replace them, if necessary
	Defective motherboard	Replace the electronic board
	Control panel broken	Replace the control panel
The stove does not run	No power supply	Check that the plug is inserted and the main switch is in the "I" position
	Pellet or water probe fault	Wait for the pellet or water tank to cool down and restart the stove
	Blown fuse	Replace the fuse
	Faulty glow plug	Check the glow plug and replace it, if necessary

ANOMALIES RELATED TO THE HYDRAULIC CIRCUIT

ANOMALY	POTENTIAL CAUSES	SOLUTIONS
No increase in temperature with stove in operation	Incorrect combustion adjustment	Check recipe
	Boiler / system dirty	Check and clean the boiler
	Insufficient stove power	Check that the stove is properly sized for the requirements of the system
	Poor pellet quality	Using pellets from the producer
Condensation in boiler	Incorrect boiler or pump temperature setting	Set the stove or the pump to a higher temperature
	Insufficient fuel consumption	Check recipe
Radiators cold in winter	Room thermostat (local or remote) set too low. If remote thermostat, check if it is defective.	Set to higher temperature or replace (if remote).
	Circulator does not run because it is blocked	Free up the circulator by removing the plug and turning the shaft with a screwdriver
	Circulator does not run	Check the electrical connections of the circulator; replace if necessary
	Radiators have air in them	Vent the radiators
Hot water is not provided	Circulator (pump) blocked	Free the circulator (pump)
Noises and gurgling	Air in the system	Release the air and fill the system



If the stove is NOT used as described in this instruction manual, the manufacturer declines all responsibility for damage to persons and property that may arise. The manufacturer furthermore denies any liability for damage to persons and property arising from failure to observe all the rules contained in the manual and specifically:

- ***The operations in italics must be carried out by specialised personnel from the manufacturer***
- ***All the necessary measures and/or precautions must be adopted when performing maintenance, cleaning and repairs.***
- ***Do not tamper with the safety devices.***
- ***Do not remove the safety devices.***
- ***Connect the stove to an efficient smoke expulsion system.***
- ***First, check that the environment where it is to be installed is properly ventilated.***

31-CIRCUIT BOARD

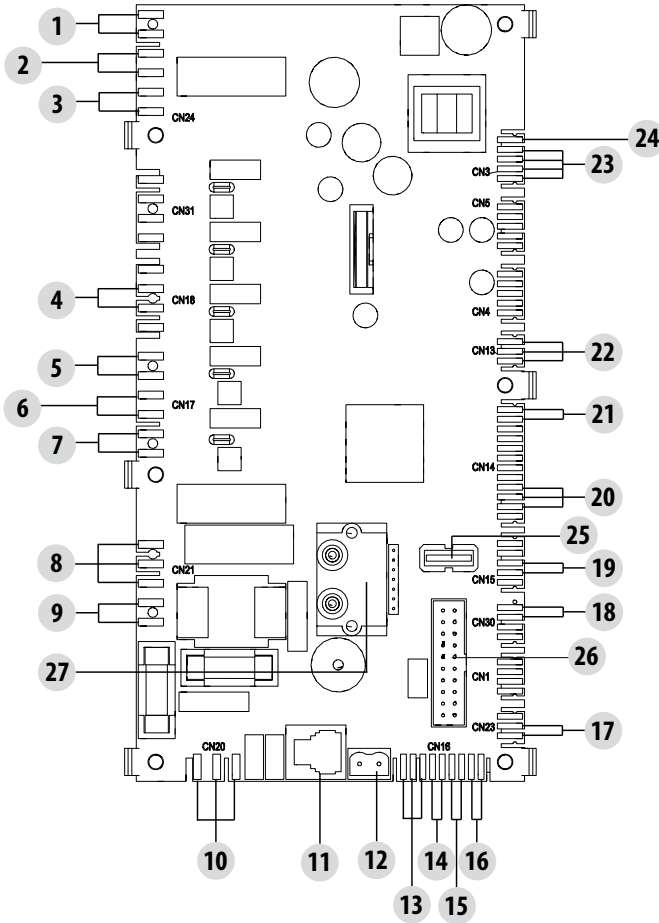

LIVE ELECTRICAL CABLES

DISCONNECT THE 230V POWER CABLE BEFORE CARRYING OUT ANY OPERATIONS ON THE ELECTRICAL BOARDS

MOTHERBOARD WIRING KEY

- | | |
|-------------------------------------|-------------------------------------|
| 1. AIR PRESSURE SWITCH | 15. ROOM PROBE / THERMOSTAT |
| 2. WATER PRESSURE GAUGE | 16. PROBE INPUT / PUFFER THERMOSTAT |
| 3. HOPPER OVERLOAD CUT-OUT | 17. PWM PUMP CONTROL |
| 4. ROOM FAN | 18. DHW FLOW SWITCH |
| 5. BRAZIER MOTOR | 19. BRAZIER LIMIT SWITCH |
| 6. SMOKE EXTRACTOR | 20. SMOKE ENCODER |
| 7. GLOW PLUG | 21. WATER PROBE |
| 8. 3-WAY VALVE | 22. PELLET LEVEL SENSOR (OPTIONAL) |
| 9. PUMP POWER SUPPLY | 23. GEAR MOTOR |
| 10. ON/OFF SWITCH | 24. 24 V SAFETY DEVICES |
| 11. CONTROL PANEL | 25. USB |
| 12. SMOKE TEMPERATURE PROBE | 26. WIFI CONTROL PANEL |
| 13. AUX RELAY (C-NO-NC) 24 V | 27. PRESSURE DIFFERENTIAL |
| 14. STORAGE TANK PROBE / THERMOSTAT | |

PLEASE NOTE The electrical wiring of individual components is fitted with pre-wired connectors of different sizes.



Via La Croce n°8
33074 Vigonovo di Fontanafredda (PN) – ITALY
Telephone: 0434/599599 a.s.
Fax: 0434/599598
Internet: www.mcz.it
e-mail: mcz@mcz.it