

Chimney fan

RSHT

High temperature resistant Exodraft fan type RSHT is a specially designed flue gas fan with horizontal discharge. It is fitted to the termination point of the chimney and there creating a negative pressure in the exhaust duct or in the chimney. The stainless steel and cast aluminium housing ensure the RSHT very high corrosion resistance. All the screws and bolts are made of stainless steel and so is the centrifugal impeller which has a very low vibration level.

The cooling wheel, patented by Exodraft, allows the fan:

- to work reliably in continuous operation with temperatures up to 500 °C
- to work in peak temperatures of up to 700 °C in 3 minutes



Technical data

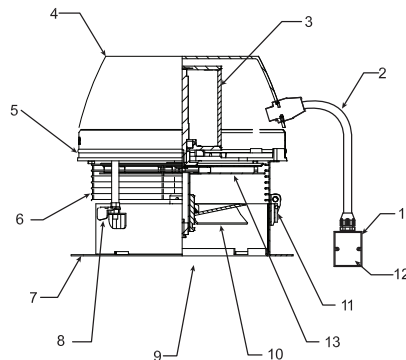
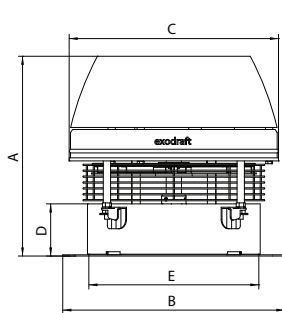

1. Capacitor and repair switch box
2. Conduit/cord
3. Motor
4. Motor housing
5. Motor plate
6. Bird screen
7. Base plate
8. Locking handle
9. Inlet
10. Axial vane
11. Hinge
12. Capacitor (inside box)
13. Cooling wheel

Model	Motor data				Weight kg	Dimension [mm]				
	rpm	V	Amp	kW*		A	BxB	C [Ø]	D	E [Ø]
RSHT009-41	1350	1 x 230	0.26	0.06	12	298	296	275	75	220
RSHT012-41	1350	1 x 230	0.55	0.09	15	325	364	344	85	280
RSHT014-41	1350	1 x 230	1.00	0.19	19	372	422	395	100	330
RSHT016-41	1350	1 x 230	1.90	0.31	22	400	478	441	100	380

*Power consumption at ambient temperature of 20 °C
 The RPM of the above fan models are infinitely adjustable
 Motor protection IP rating IP54
 Insulation class F

Sound data

Model	Lw [dB]							Lp dB [A]
	125 Hz	250 Hz	500 Hz	1000 Hz	2000 Hz	4000 Hz	8000 Hz	
RSHT009-41	66	61	63	57	58	57	51	37
RSHT012-41	72	74	71	65	66	62	54	33
RSHT014-41	80	76	72	70	71	68	61	49
RSHT016-41	84	81	75	74	73	70	65	52

Tolerance +/- 3 dB.
 Lw = sound effect level dB (reference: 1 pW)
 Lp = sound pressure level dB [A] at 10 m distance from the fan at half spheric sound distribution
 Lp (5 m) = Lp (10 m) + 6 dB
 Lp (20 m) = Lp (10 m) - 6 dB

Capacity diagrams

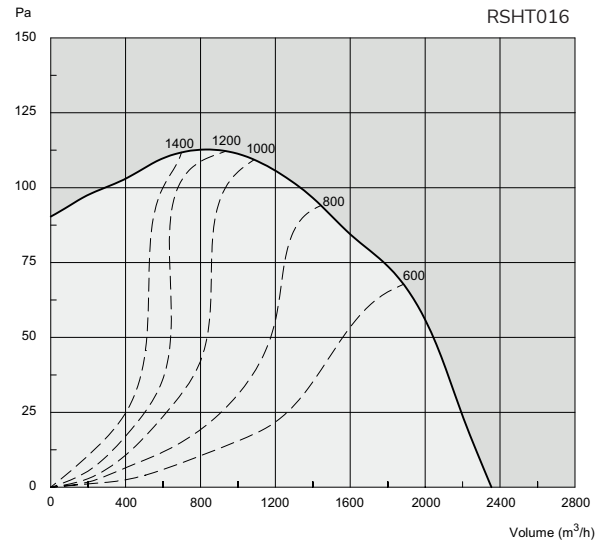
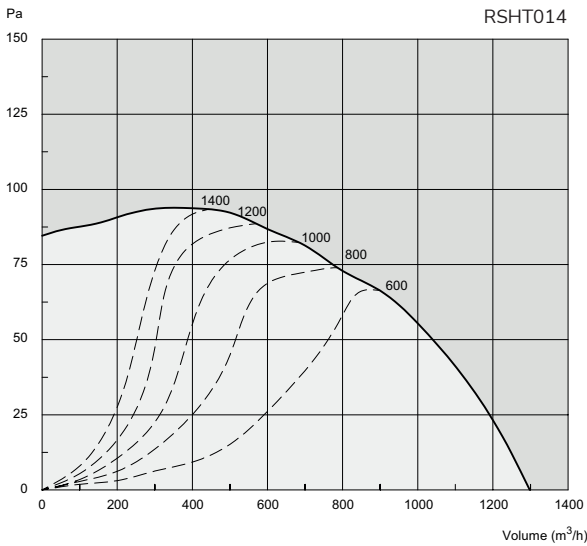
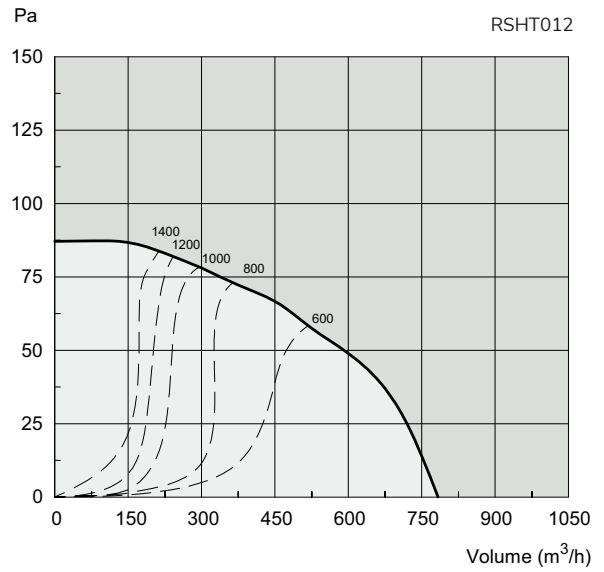
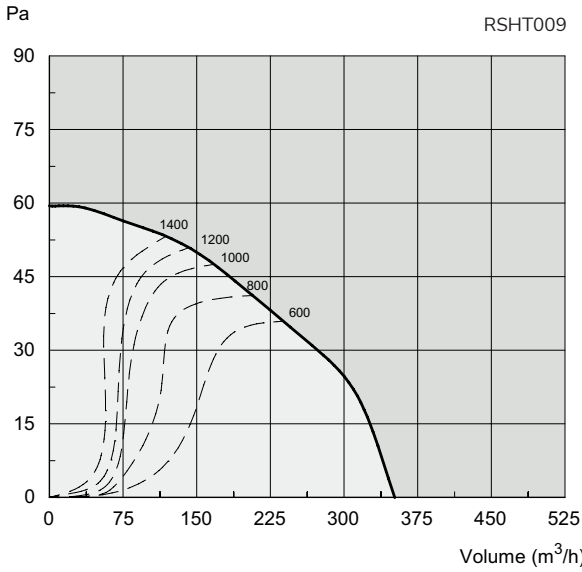

----- Specific Fan Power (SFP) curve
 ——— Capacity curve

SFP

SFP = (joule/m³)
 P1 = consumption (watt)
 qv = flow (m³/h)

$$P1 = \frac{SFP \times qv}{3600}$$

Capacity curve

The capacity diagrams are measured with a flue gas temperature of 20 °C. The fan's capacity changes with the temperature of the flue gases. The correction of the capacity can be calculated using the following equation:

$$Ps_{20} = Ps_t \times \frac{(273 + t)}{293}$$

Ps = static pressure
 t = temperature measured in °C

Example: (RSHT012)

System demand: 600 m³/h and 32 Pa at 180 °C
 Fan selection: 600 m³/h and 50 Pa at 20 °C

Sound data RSHT009

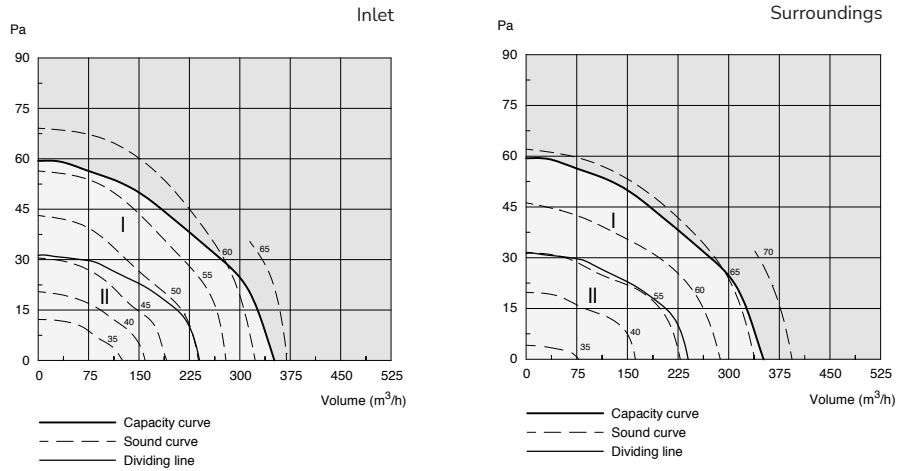

Table 1
Correction factors for calculating sound output in the first octave band to extractor channel and surroundings. [dB]

	Area	63Hz	125 Hz	250 Hz	500 Hz	1000 Hz	2000 Hz	4000 Hz	8000 Hz
Inlet channel (K_{W1})	I	16	13	3	-6	-12	-13	-18	-26
	II	18	12	1	-5	-8	-13	-18	-23
Surroundings (K_{W2})	I	2	1	-4	-2	-8	-7	-8	-14
	II	12	8	-1	-2	-7	-10	-10	-13

Table 2
Correction factors for calculating A-weighted sound pressure to surroundings [dB(A)]

	Area	10m							
Pressure (K_{pA})	I	-28							
	II	-28							

Table 3
Example: Sound power output level for inlet channel [dB] = (Readings in Diagram A) + (Correction factor in Table 1)

	Area	63Hz	125 Hz	250 Hz	500 Hz	1000 Hz	2000 Hz	4000 Hz	8000 Hz
Sound power output to inlet channel in the first octave band (L_{W1})	I	73	70	60	51	45	44	39	31
	II	-	-	-	-	-	-	-	-

Table 4
Example: Sound power output level for surroundings [dB] = (Readings in Diagram B) + (Correction factor in Table 1)

	Area	63Hz	125 Hz	250 Hz	500 Hz	1000 Hz	2000 Hz	4000 Hz	8000 Hz
Sound power output to surroundings in the first octave band (L_{W3})	I	65	64	59	61	55	56	55	49
	II	-	-	-	-	-	-	-	-

Table 5
Example: Sound pressure to surroundings [dB(A)] = (Readings in Diagram B) + (Correction factor in Table 2)
Every time that distance doubles another 6 dB is withdrawn. Example: 20m = 63 - 28 - 6 = 29

A-weighted sound pressure in () meters distance (L_{pA3})	Area	10m	20m	40m	80m				
	I	35	29	23	17				
	II	-	-	-	-				

Example: For the values in Table 3 is read the factor (L_{W1}) in Diagram A at 2/3 of max. flow.
2/3 of 250 M³/h = 167 M³/h
Reading = 57

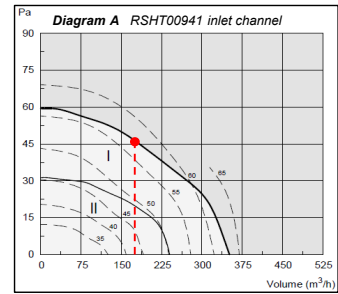

Example: For the values in Table 4 and Table 5 is read the factor (L_{W3}) in Diagram B at 2/3 of max. flow.
2/3 of 250 M³/h = 167 M³/h
Reading = 63

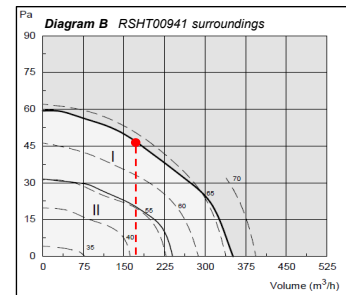

K_{W1} : Correction factor for calculating sound output in the first octave band.
 K_{pA} : Correction factor for calculating A-weighted sound pressure.

L_{W1} : Sound output level for inlet channel
 L_{W3} : Sound output level to surroundings
 L_{pA3} : Sound pressure level dB(A) at a distance of 10 metres from hemi-spherical sound dissipation in free field and with insulated connection ducts.

I: Upper operating area.
II: Lower operating area.
 L_{W1} can be read from the curve diagram.
 L_{W3} can be read from the curve diagram.

Sound data RSHT012

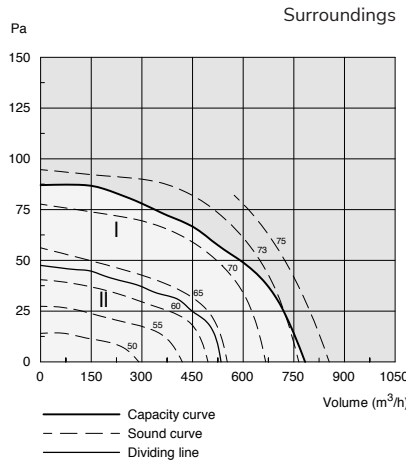
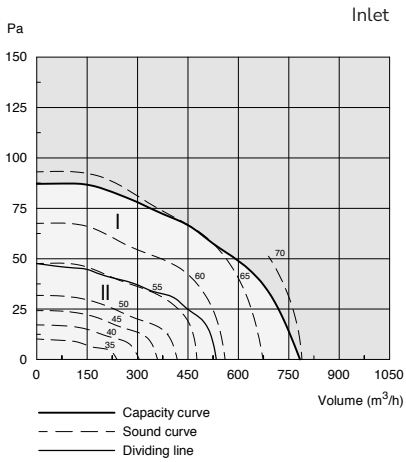

Table 1
Correction factors for calculating sound output in the first octave band to extractor channel and surroundings. [dB]

	Area	63Hz	125 Hz	250 Hz	500 Hz	1000 Hz	2000 Hz	4000 Hz	8000 Hz
Inlet channel (K_{W1})	I	15	12	3	-7	-11	-14	-17	-23
	II	18	12	2	-5	-9	-13	-22	-29
Surroundings (K_{W2})	I	0	-1	1	-2	-8	-7	-11	-19
	II	8	6	4	-5	-8	-9	-13	-18

Table 2
Correction factors for calculating A-weighted sound pressure to surroundings [dB(A)]

	Area	10m							
Pressure (K_{PA})	I	-28							
	II	-28							

Table 3
Example: Sound power output level for inlet channel [dB] = (Readings in Diagram A) + (Correction factor in Table 1)

	Area	63Hz	125 Hz	250 Hz	500 Hz	1000 Hz	2000 Hz	4000 Hz	8000 Hz
Sound power output to inlet channel in the first octave band (L_{W1})	I	80	77	68	58	54	51	48	42
	II	-	-	-	-	-	-	-	-

Table 4
Example: Sound power output level for surroundings [dB] = (Readings in Diagram B) + (Correction factor in Table 1)

	Area	63Hz	125 Hz	250 Hz	500 Hz	1000 Hz	2000 Hz	4000 Hz	8000 Hz
Sound power output to surroundings in the first octave band (L_{W2})	I	71	70	72	69	63	64	60	52
	II	-	-	-	-	-	-	-	-

Table 5
Example: Sound pressure to surroundings [dB(A)] = (Readings in Diagram B) + (Correction factor in Table 2)
Every time that distance doubles another 6 dB is withdrawn. Example: 20m = 71 - 28 - 6=37

	Area	10m	20m	40m	80m				
A-weighted sound pressure in () meters distance (L_{PA3})	I	43	37	31	25				
	II	-	-	-	-				

Example: For the values in Table 3 is read the factor (L_{WA1}) in Diagram A at 2/3 of max. flow.
2/3 of 825 M³/h = 550 M³/h
Reading = 65

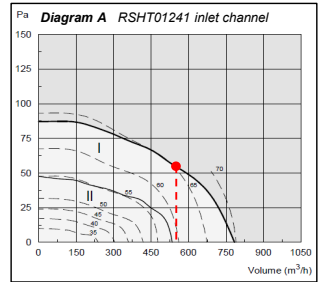

Example: For the values in Table 4 and Table 5 is read the factor (L_{WA3}) in Diagram B at 2/3 of max. flow.
2/3 of 825 M³/h = 550 M³/h
Reading = 71

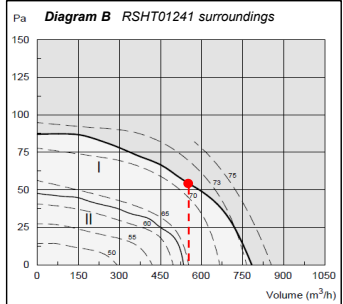

K_{W1} : Correction factor for calculating sound output in the first octave band.
 K_{PA} : Correction factor for calculating A-weighted sound pressure.

L_{W1} : Sound output level for inlet channel
 L_{W2} : Sound output level to surroundings
 L_{PA3} : Sound pressure level dB(A) at a distance of 10 metres from hemi-spherical sound dissipation in free field and with insulated connection ducts..

I: Upper operating area.
II: Lower operating area.
 L_{WA1} can be read from the curve diagram.
 L_{WA3} can be read from the curve diagram.

Sound data RSHT014

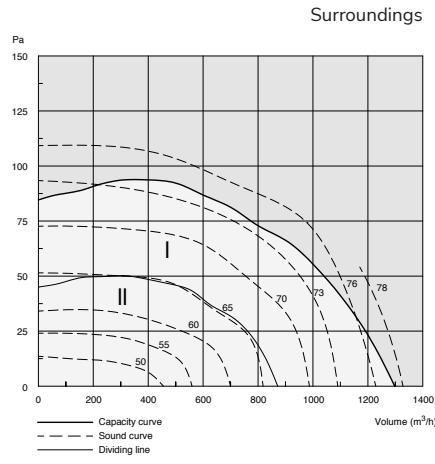
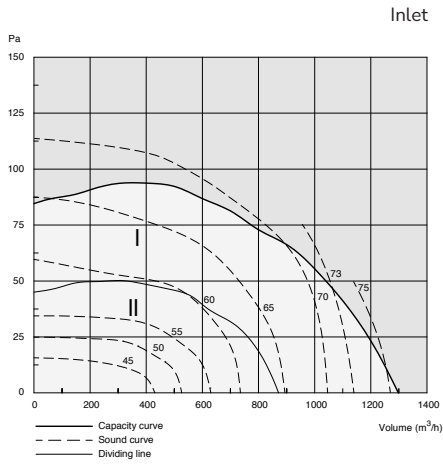

Table 1
Correction factors for calculating sound output in the first octave band to extractor channel and surroundings. [dB]

	Area	63Hz	125 Hz	250 Hz	500 Hz	1000 Hz	2000 Hz	4000 Hz	8000 Hz
Inlet channel (K_{W1})	I	14	13	3	-7	-9	-13	-17	-20
	II	17	11	2	-2	-11	-17	-25	-29
Surroundings (K_{W2})	I	4	3	-1	-5	-7	-6	-9	-16
	II	11	5	1	-2	-8	-9	-12	-18

Table 2
Correction factors for calculating A-weighted sound pressure to surroundings [dB(A)]

	Area	10m						
Pressure (K_{pA})	I	-28						
	II	-28						

Table 3
Example: Sound power output level for inlet channel [dB] = (Readings in Diagram A) + (Correction factor in Table 1)

	Area	63Hz	125 Hz	250 Hz	500 Hz	1000 Hz	2000 Hz	4000 Hz	8000 Hz
Sound power output to inlet channel in the first octave band (L_{W1})	I	83	82	72	62	60	56	52	49
	II	-	-	-	-	-	-	-	-

Table 4
Example: Sound power output level for surroundings [dB] = (Readings in Diagram B) + (Correction factor in Table 1)

	Area	63Hz	125 Hz	250 Hz	500 Hz	1000 Hz	2000 Hz	4000 Hz	8000 Hz
Sound power output to surroundings in the first octave band (L_{W3})	I	78	77	73	69	67	68	65	58
	II	-	-	-	-	-	-	-	-

Table 5
Example: Sound pressure to surroundings [dB(A)] = (Readings in Diagram B) + (Correction factor in Table 2)
Every time that distance doubles another 6 dB is withdrawn. Example: 20m = 74 - 28 - 6=40

	Area	10m	20m	40m	80m			
A-weighted sound pressure in () meters distance (L_{pA3})	I	46	40	34	28			
	II	-	-	-	-			

Example: For the values in Table 3 is read the factor (L_{WA1}) in Diagram A at 2/3 of max. flow.
2/3 of 1300 M³/h = 867 M³/h
Reading = 69

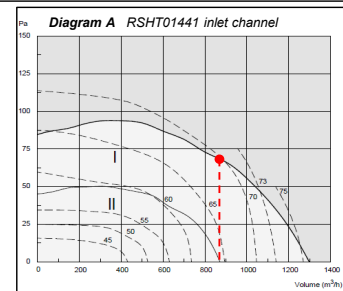

Example: For the values in Table 4 and Table 5 is read the factor (L_{WA3}) in Diagram B at 2/3 of max. flow.
2/3 of 1300 M³/h = 867 M³/h
Reading = 74

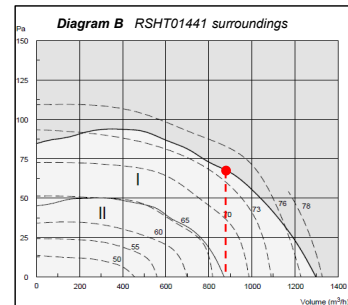

K_{W1} : Correction factor for calculating sound output in the first octave band.
 K_{pA} : Correction factor for calculating A-weighted sound pressure.

L_{W1} : Sound output level for inlet channel
 L_{W3} : Sound output level to surroundings
 L_{pA3} : Sound pressure level dB(A) at a distance of 10 metres from hemi-spherical sound dissipation in free field and with insulated connection ducts..

I: Upper operating area.
II: Lower operating area.
 L_{WA1} can be read from the curve diagram.
 L_{WA3} can be read from the curve diagram.

Sound data RSHT016

Inlet

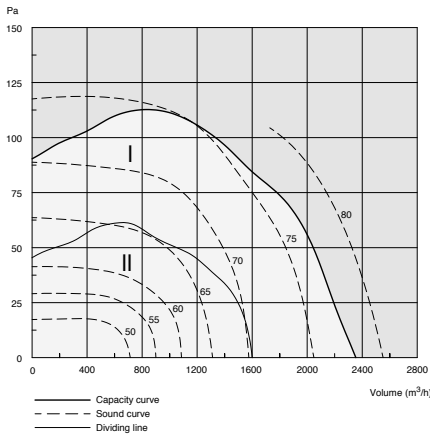

Surroundings

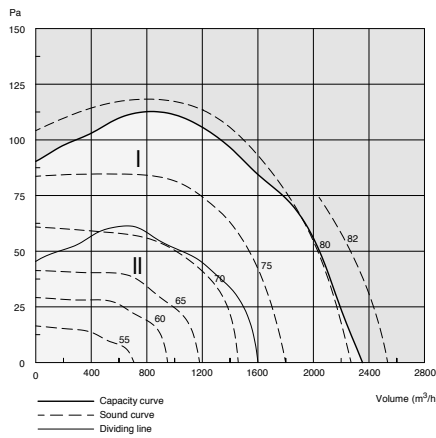

Table 1									
Correction factors for calculating sound output in the first octave band to extractor channel and surroundings. [dB]									
	Area	63Hz	125 Hz	250 Hz	500 Hz	1000 Hz	2000 Hz	4000 Hz	8000 Hz
Inlet channel (K_w)	I	15	12	3	-7	-9	-14	-15	-18
	II	18	11	3	-6	-9	-18	-23	-29
Surroundings (K_w)	I	5	4	1	-5	-6	-7	-10	-15
	II	9	4	4	-4	-8	-11	-15	-21

Table 2								
Correction factors for calculating A-weighted sound pressure to surroundings [dB(A)]								
	Area	10m						
Pressure (K_{pA})	I	-28						
	II	-28						

Table 3									
Example: Sound power output level for inlet channel [dB] = (Readings in Diagram A) + (Correction factor in Table 1)									
	Area	63Hz	125 Hz	250 Hz	500 Hz	1000 Hz	2000 Hz	4000 Hz	8000 Hz
Sound power output to inlet channel in the first octave band (L_{W1})	I	91	88	79	69	67	62	61	58
	II	-	-	-	-	-	-	-	-

Table 4									
Example: Sound power output level for surroundings [dB] = (Readings in Diagram B) + (Correction factor in Table 1)									
	Area	63Hz	125 Hz	250 Hz	500 Hz	1000 Hz	2000 Hz	4000 Hz	8000 Hz
Sound power output to surroundings in the first octave band (L_{W3})	I	83	82	79	73	72	71	68	63
	II	-	-	-	-	-	-	-	-

Table 5								
Example: Sound pressure to surroundings [dB(A)] = (Readings in Diagram B) + (Correction factor in Table 2)								
Every time that distance doubles another 6 dB is withdrawn. Example: 20m = 78 - 28 - 6=44								
	Area	10m	20m	40m	80m			
A-weighted sound pressure in () meters distance (L_{pA3})	I	50	44	38	32			
	II	-	-	-	-			

Example: For the values in Table 3 is read the factor (L_{WA1}) in Diagram A at 2/3 of max. flow.
2/3 of 2375 M³/h = 1583 M³/h
Reading = 76

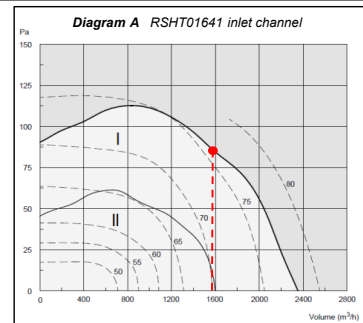

Example: For the values in Table 4 and Table 5 is read the factor (L_{WA3}) in Diagram B at 2/3 of max. flow.
2/3 of 2375 M³/h = 1583 M³/h
Reading = 78

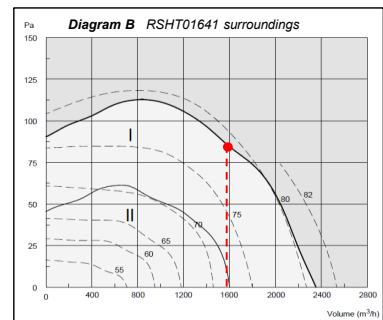

K_w : Correction factor for calculating sound output in the first octave band.
 K_{pA} : Correction factor for calculating A-weighted sound pressure.

L_{W1} : Sound output level for inlet channel
 L_{W3} : Sound output level to surroundings
 L_{pA3} : Sound pressure level dB(A) at a distance of 10 metres from hemi-spherical sound dissipation in free field and with insulated connection ducts..

I: Upper operating area.
II: Lower operating area.
 L_{WA1} can be read from the curve diagram.
 L_{WA3} can be read from the curve diagram.