



SEALED PELLET STOVE

EGO Hydromatic 12 M2 STAR Hydromatic 12 M2

PART 2 - OPERATION AND CLEANING

Translation of original instructions

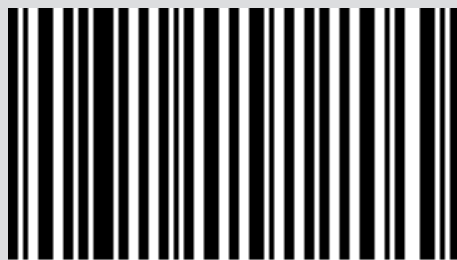

8902122201

TABLE OF CONTENTS

TABLE OF CONTENTS	II
19-FIRST START-UP	3
20-GRAPHIC PANEL	4
21-DISPLAYS	6
22-SELECTING THE OPERATING MODES.....	12
23 - FANS.....	17
24-START&STOP	18
25-CHRONO-SLEEP	21
26 - WI-FI/WPS/BLUETOOTH	30
27-SHUTDOWN	33
28-EXTRA DISPLAYS	34
29-USER MENU	36
29-USER MENU	37
30-PELLET LEVEL SENSOR.....	47
31-CONNECTIONS	48
32-SAFETY DEVICES AND ALARMS	49
33-RECOMMENDATIONS FOR SAFE USE	55
34-CLEANING	56
35-TROUBLESHOOTING	63
36-CIRCUIT BOARD	66

19-FIRST START-UP

WARNINGS BEFORE IGNITION

GENERAL WARNINGS

Remove all parts that may burn from the brazier and the glass (manual, various adhesive labels or any polystyrene).

Check that the brazier is positioned correctly and rests properly on the base.



The first ignition may not be successful as the feed screw is empty and does not always manage to load the brazier with the required amount of pellets in time to light the flame.



**CLEAR THE FAILED IGNITION ALARM FROM THE STOVE PANEL OR APP.
REMOVE THE PELLETS LEFT IN THE BRAZIER AND REPEAT IGNITION.**

If, after repeated attempts, the flame fails to ignite, despite a regular flow of pellets, check the correct positioning of the brazier, which **must rest snugly against the slots**. If no anomaly is found during this inspection, there may be a problem with the product components or installation may not be correct.



REMOVE THE PELLETS FROM THE BRAZIER AND CONTACT AN AUTHORISED TECHNICIAN.



Do not touch the stove during the first start-up, as it is during this phase that the paint sets. If you touch the paint, you may expose the steel surface.



It is good practice to ensure effective ventilation in the room during the initial start-up, as the stove will emit some smoke and smell of paint.

If necessary, touch up the paint with the spray can of the specific colour.

Do not stand close to the stove and, as mentioned, air out the room. The smoke and smell of paint will disappear after about an hour of operation, however, they are not harmful in any case.



The product will be subject to expansion and contraction during the start-up and cooling stages, therefore slight creaking noises may be heard. This is perfectly normal as the structure is made of laminated steel and must not be considered a defect.

Upon **first ignition**, for the first pellet hopper, it is recommended to start the stove at maximum power so that the structure and the smell of the paint settle more quickly.

It is recommended to install the ceramic or serpentine stone cladding after the first successful ignition.



DO NOT EXPECT HEATING EFFICIENCY IMMEDIATELY!!!

20-GRAPHIC PANEL

MAESTRO GRAPHIC PANEL

The “foldaway” panel is located at the back of the product. Grasp the panel at the sides with your hand and lift it. The panel will block in the raised position. The display is graphic only while the controls are “soft touch”



Attention! It is advisable to put the panel in the “HIDDEN” position while loading the pellet.



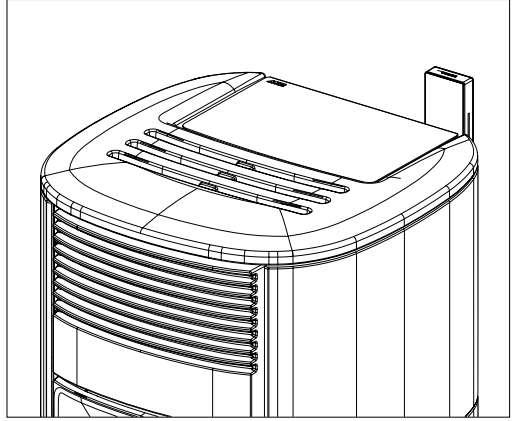
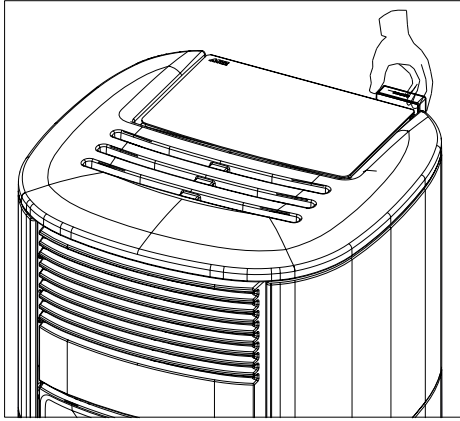



It is not necessary to guide the panel into the “CONCEALED” position.

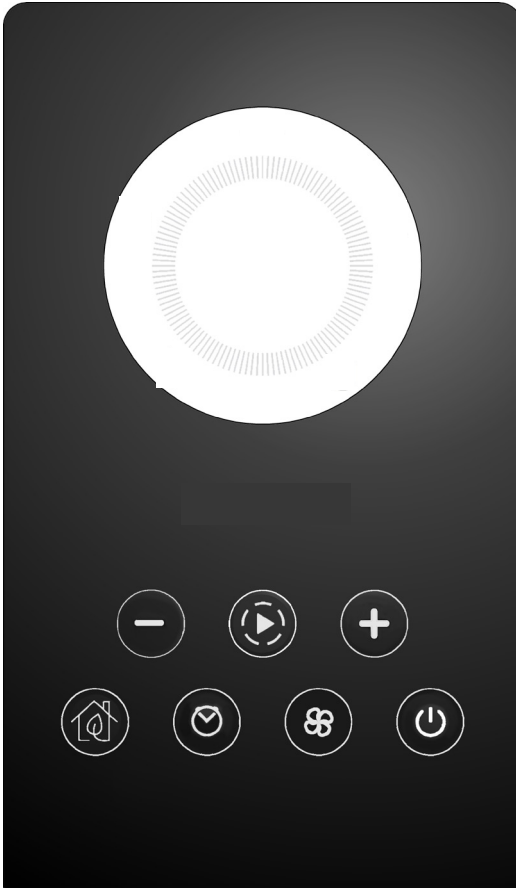

20-GRAPHIC PANEL

KEY FUNCTIONS



	CONTROL AND MENU SCROLLING KEYS		FAN CONTROL MENU
	NAVIGATION IN THE DIFFERENT OPERATING MODES (PROGRAMMES)		ON/OFF AND CONFIRMATION OF MENU CHOICES
	START&STOP ENABLING/DISABLING		GRAPHIC DISPLAY
	CHRONO/SLEEP ENABLING/DISABLING		

21-DISPLAYS

DISPLAY AT FIRST PRODUCT IGNITION

The display shows an additional sequence to that described in the following paragraph only when the product is first powered up. This additional sequence makes it possible to adjust/confirm the current date and time (to make the adjustment later, see the dedicated user menu paragraph).



DISPLAY UPON SUBSEQUENT PRODUCT FEEDING

Each time the product is powered, the display shows the following sequence:

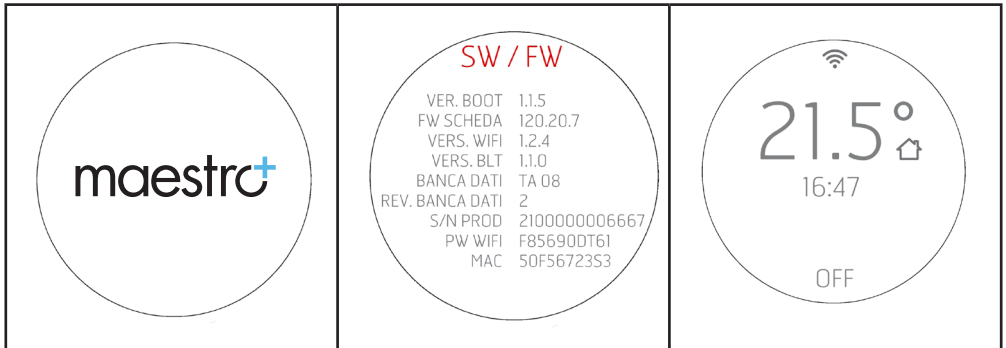



The Bluetooth sensor (if active) will search for the previously paired devices (see the Bluetooth chapter).

21-DISPLAYS

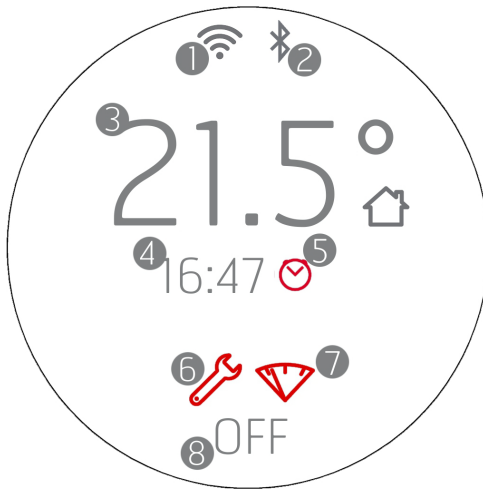
Display with the product off



1. WI-FI active and connected, the  icon is only present if the product is connected to a router or a network.
2. Bluetooth active and/or connected. The  icon is present if the Bluetooth has been activated and turns blue if it is connected to a paired device.
3. Room temperature recorded by the local probe or remote control (OPTIONAL)
4. Current time
5. Active Chrono Programming
6. Icon that identifies the need for end-of-season maintenance (2000 h)
7. Pellet reserve light (OPTIONAL)
8. OFF/STANDBY in case of active START&STOP.

The keys are all lit because during this phase each key can allow you to activate functions or access dedicated menus
The  icon has a steady white light if the product is off and cold. For the other lighting states of the key, see the shutdown chapters.

After 2 minutes (standard time that can be changed from the menu), the displays goes into standby/energy saving mode (see chap. "DISPLAYS")

21-DISPLAYS

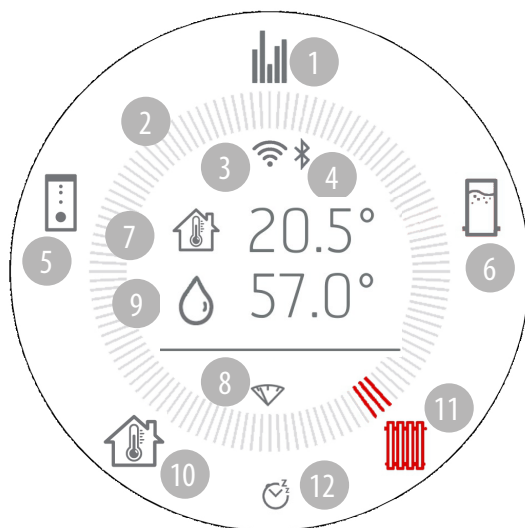

Display with the product on



1. On
2. Operating mode crown
3. WI-FI active and connected
4. Bluetooth active and connected
5. Puffer
6. Storage tank
7. Room temperature
8. Pellet reserve light (OPTIONAL)
9. Temperature of water in the boiler
10. Room temperature
11. Radiators
12. Timer or Sleep active (see dedicated paragraph for the correct iconography for each function)

21-DISPLAYS

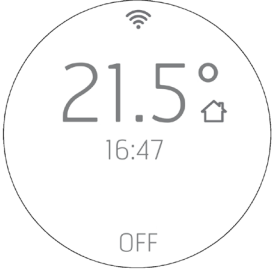
PRODUCT IGNITION

 A circular display with a white background and a thin black border. At the top center is a Wi-Fi signal icon. Below it, the temperature '21.5°' is displayed in a large font, with a small house icon to its right. Underneath the temperature is the time '16:47'. At the bottom center, the word 'OFF' is displayed in a smaller font.	 A circular display with a white background and a thin black border. At the top center is a Wi-Fi signal icon. Below it, the temperature '21.5°' is displayed in a large font, with a small house icon to its right. Underneath the temperature is the time '16:47'. At the bottom center, there is a house icon with a flame inside, and the word 'ON' is displayed below it.
<p>DISPLAY WITH THE PRODUCT OFF</p> <p>When the display is in stand-by with the product off, the room temperature, the current time and the word OFF appear; the keys below turn off.</p> <p>Simply press any key to awaken the display from this state. The panel automatically goes into STAND-BY mode after a 2" time-out (the time can be changed from the panel menu). The stand-by mode still indicates changes in the operating mode of the equipment (e.g.: pellet reserve, shutdown or cooling) and the room temperature changes with a 60 second interval.</p>	<p>DISPLAY WITH THE PRODUCT ON</p> <p>When the display is in stand-by with the product on, the room temperature, the current time, the word ON and the equipment operating mode icon appear.</p> <p>Simply press any key to awaken the display from this state.</p>

21-DISPLAYS

IGNITION

FEED SCREW ACTIVATION (FIRST IGNITION OR AFTER HOPPER EMPTYING)

Prior to first product ignition, it is necessary to load the fuel and preload the pellets inside the feed screw for loading the fuel in the brazier.



To do this, simply press and hold the  key for 10 seconds and the "feed screw loading" will activate.

The  button turns red until the phase ends or is interrupted.

To activate this function, the product must be OFF and COLD (the  key must be white and NOT flashing).

The display shows the feed screw icon and the countdown starting from the maximum number of seconds provided for the preload cycle (e.g. 120 seconds).



RED ICON





The moment you start to see the pellet drop into the brazier, you must stop loading by pressing the  key.



Ignition must start with an empty brazier and not with a preload.

Display upon ignition

Display at first ignition:

- Press and hold the  key for at least 2" (after having awakened the display), the product switches to on and the  key flashes until the ignition phase has been completed. The crown appears and moves to the icon at the top, relative to general operation

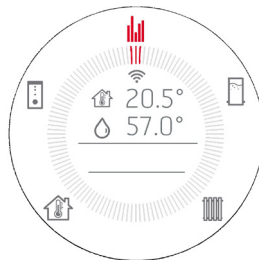

- The room temperature reading appears
- Upon first ignition, only three icons are enabled (general operation/room temperature/system temperature) the others are displayed but not enabled
- If you later decide to enable the puffer or storage tank outputs, the other icons will also be enabled (see "User menu" chap.).
- The icon for the stove appears as well as the power request from the various radiators/puffers/storage/DHW.

21-DISPLAYS



Attention! Representation with all of the crown icons provided by way of example, see chapters below for enabling.

Below is a series of representations:



<p>STOVE ON WITH PUMP ON AND REQUEST FROM THE SYSTEM</p>	<p>STOVE ON WITH PUMP ON AND REQUEST FROM DHW</p>	<p>STOVE ON WITH PUMP ON AND REQUEST FROM STORAGE TANK</p>
<p>STOVE ON WITH PUMP ON AND REQUEST FROM PUFFER</p>	<p>STOVE ON WITH PUMP ON (NO REQUEST-STOVE ON MINIMUM)</p>	

SELECTION OF SYSTEM COMPONENTS (USES) SUCH AS PUFFER/STORAGE TANK

These functions can be activated from the specific MENU from the stove panel. The adjustment must be made only one time when the system is installed by the qualified technician.

The adjustment of the hysteresis must be made by the installation technician through the APP.

22-SELECTING THE OPERATING MODES

Scroll with . Every time it is pressed, the next icon on the crown will light up. The icon and the dashes will turn red. It will be confirmed automatically 3" after selection. Use the   keys to select the desired temperature

GENERAL OPERATION SCREEN







When the start-up stage is complete, the screen appears with information on room temperature and system status, and on what the stove is doing (e.g.: pump on and heat request from DHW). During operation, the  key stays on steady and white.

 STOVE WATER TEMPERATURE
 ROOM TEMPERATURE

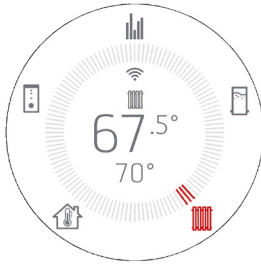
22-SELECTING THE OPERATING MODES

STOVE BOILER TEMPERATURE ADJUSTMENT SCREEN - INSTALLATION SET 1 CONFIGURATION





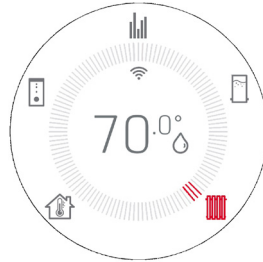



- With the  key, access stove boiler temperature adjustment.
- The current temperature of the water in the stove boiler will appear in large characters, and the desired temperature at the bottom in small characters
- The   keys allow you to modify the temperature and if you press them, all the texts at the centre of the display disappear and only the current setting appears.

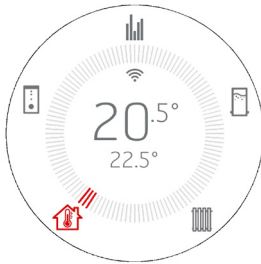

- The first press only enters the edit mode; pressing the   keys again will change the value. The display lasts 3" and in case of no further inputs, it returns to the image with the crown and updated temperature.

ROOM TEMPERATURE ADJUSTMENT SCREEN





- With the  key, access the room temperature adjustment.
- The current room temperature will appear in large characters, and the desired temperature at the bottom in small characters (as on the APP)
- The   keys allow you to modify the temperature and if you press them, all the texts at the centre of the display disappear and only the current setting appears.
- The first press only enters the edit mode; pressing the   keys again will change the value. The display lasts 3" and in case of no further inputs, it returns to the image with the crown and updated temperature.



22-SELECTING THE OPERATING MODES

DOMESTIC HOT WATER TEMPERATURE ADJUSTMENT SCREEN (ONLY DHW VERSION MODELS)- INSTALLATION SET 2 CONFIGURATION

- With the  key, access DHW temperature adjustment.
- The current DHW temperature will appear in large characters
- The   keys allow you to edit the temperature.
- The first press only enters the edit mode; pressing the   keys again will change the value. It will be confirmed automatically.

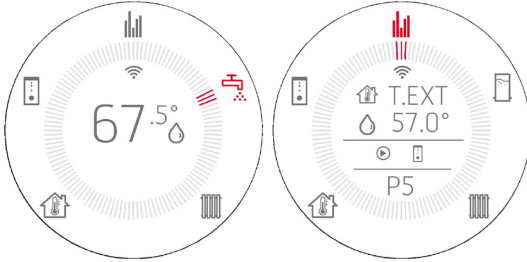

DISPLAY WITH EXTERNAL THERMOSTAT (see "User Menu" chap.)

ON/OFF alternating with T.EXT
where ON and OFF indicate whether there is a call
or not (and not whether the external thermostat
is active or not)

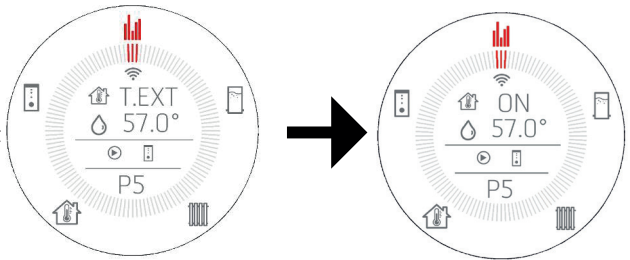

When there is an external thermostat, the room temperature adjustment screen is as follows:



When setting an AUX configuration (2-3 see "User Menu" chap.) to set the temperature of the AUX contact on the NTC1, always use the screen relative to the temperature setting of the room where it is represented:

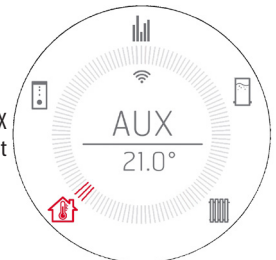



22-SELECTING THE OPERATING MODES

STORAGE TANK TEMPERATURE ADJUSTMENT SCREEN - NTC3 ACTIVE-INSTALLATION SET 3-4 CONFIGURATION

(SEE SYSTEM CONFIGURATION IN THE USER MENU)

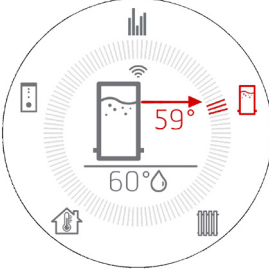
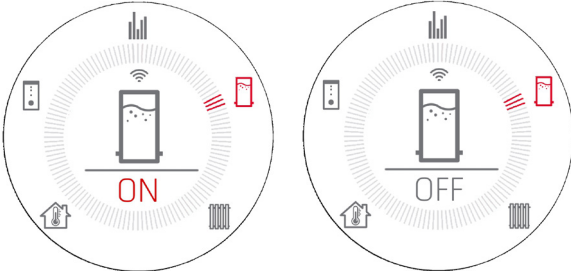
With the  key, access the storage tank temperature adjustment.

	<p>The STORAGE TANK screen with probe appears when INSTALLATION SET 4 CONFIGURATION is activated. At the bottom of the display, the temperature SET appears, and at the top the storage tank temperature recorded by the NTC.</p>
	<p>If the INSTALLATION SET 3 STORAGE TANK CONFIGURATION with thermostat (dry contact) is set, only ON/OFF will appear at the bottom. ON appears in red. OFF appears in grey.</p>

- The   keys allow you to edit the temperature. By pressing the keys, at the centre of the display, all of the words will disappear and only the current setting is shown.

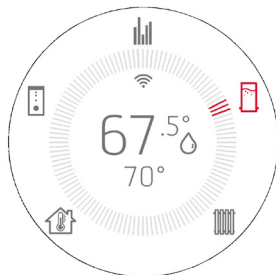

- The first press only enters the edit mode; pressing the   keys again will change the value. The display lasts 3" and in case of no further inputs, it returns to the image with the crown and updated temperature.

22-SELECTING THE OPERATING MODES



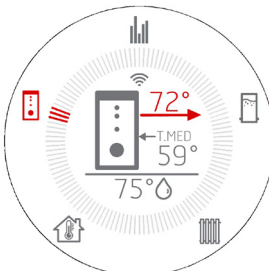
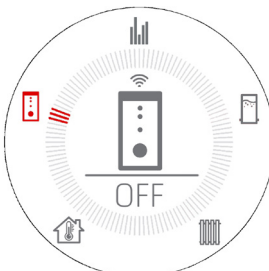
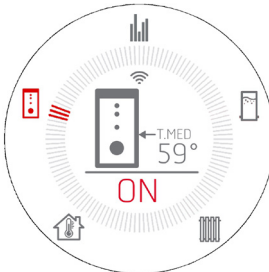

PUFFER TEMPERATURE ADJUSTMENT SCREEN - NTC2 ACTIVE-INSTALLATION SET 5-6 CONFIGURATION

(SEE SYSTEM CONFIGURATION IN THE USER MENU)

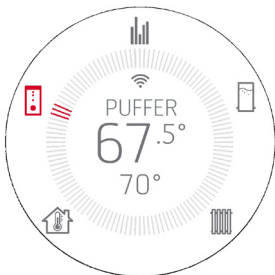
With the  key, access the puffer temperature adjustment.

	<p>The PUFFER screen with probe appears when the INSTALLATION SET 6 CONFIGURATION is active.</p> <p>At the bottom of the screen the temperature SET appears, at the top the withdrawal HIGH probe temperature (NTC2) and if you decide to also enable NTC3 (READ-ONLY) the T.MED (average temperature or mid puffer) indication appears to include the stratification rating (NTC3 = T.MED).</p>
	<p>On the other hand, if you select INSTALLATION SET 5 PUFFER CONFIGURATION with thermostat, only ON/OFF will appear at the bottom. ON appears in red. OFF appears in grey.</p>
	<p>If NTC 2 is set in T.EXT you can nevertheless set NTC 3 in T.MED to activate the reading of the puffer's average temperature (without the possibility of adjustment), to include the stratification rating.</p>









- The   keys allow you to edit the temperature. By pressing the keys, all of the words at the centre of the display disappear, leaving only the current setting visible.
- The first press only enters the edit mode and shows the screen illustrated above; pressing the   keys again will change the value. Confirmation is automatic after a few seconds of inactivity.

23 - FANS

FAN ADJUSTMENT (PRE-SET MODELS ONLY)

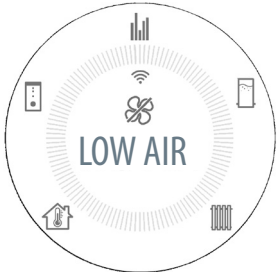
From the database, if the fan is active, the  key is activated and it is possible to perform these adjustments



<p>Press the key once</p>  <p>(tangential fan)</p>	<ul style="list-style-type: none">• Press once to go to the editing view.• The   keys are used to edit fan speed.• The display lasts 3" and in case of no further inputs, it returns to the image with the crown and previous operating mode.
	<p>PLEASE NOTE If the product does not feature a room fan, this key will be disabled.</p>
	<p>LOW AIR fan adjustment If the fan is set to zero (0), the  fan icon turns to LOW AIR, the minimum fan value allowed according to the powers. LOW AIR will therefore be displayed.</p>

24-START&STOP

START&STOP

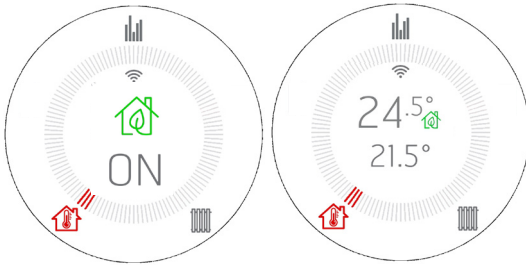
The START&STOP function switches off the product when it reaches the required room temperature and if the set temperature hysteresis is also respected.



By pressing the  button the START&STOP function is started. The icon will appear for 3", and then go back to the previous view, where the house near the temperature turns into the  icon, as a reminder that it is activated.



When the room temperature reaches the set temperature and all the other parameters are also respected (see the next paragraph), the equipment switches off and the display indicates the room temperature, the current time and the STANDBY indication to indicate the standby mode, which allows the product to turn on again as soon as the temperature drops below the set threshold or if the intended temperature in the room increases.

The  key appears steady green once the panel is activated.

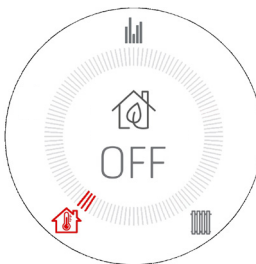

Deactivate by simply pressing the button again and the house icon returns to how it was previously.

START&STOP is recommended for well-insulated rooms where even with the stove at minimum power, the temperature will rise.

On the other hand, it is not recommended where the product is forced to switch on and off frequently (for example after at least 1 hour of operation) because in this way, besides premature wear of the glow plug, the product never manages to reach full efficiency and temperature, thereby causing greater accumulation of ash or even condensation.

24-START&STOP

INTERVENTION DELAY (ADJUSTMENTS OF THE START&STOP TEMPERATURE HYSTERESIS)

When the room temperature is reached, there is a waiting time for intervention to prevent the equipment from suddenly turning on/off as the room temperature drops/rises, for example, when a door or an external window is opened. This waiting time therefore allows you to be sure that the room temperature has actually dropped for a certain time inside the room (for example 5 minutes).

There is also a temperature threshold beyond which the equipment reacts to in the event of switching on and off and this is called hysteresis. The NEGATIVE hysteresis identifies the temperature delta, outside of which the appliance must switch back on. The POSITIVE hysteresis identifies the temperature delta, outside of which the appliance must switch off. The hysteresis are both included in the user menu.

Example1: With the product switched on, POSITIVE hysteresis is 2°C. The room temperature is 21°C and the set temperature is 22°C. The product will remain on until the room temperature is exceeded by 2°C and therefore, when $T > 23.0^{\circ}\text{C}$

Example2: With the product off, NEGATIVE hysteresis is 2°C. The room temperature is 19°C and the set temperature is 20°C. The product will remain off until the set temperature drops 2°C and therefore, when $T < 18.0^{\circ}\text{C}$

Factory settings: POSITIVE HYSTERESIS = 0
NEGATIVE HYSTERESIS = 2°



FORCED RESTART FROM START&STOP WITH BUTTON OR TEMPERATURE

As previously mentioned, when a shutdown occurs via START&STOP, the display indicates the off condition with the  icon, the  key remains green and the word STAND BY is displayed.



GREEN ICON

In this display condition, the product can be turned back on as follows:

1. Wait for the room temperature to drop below the intended temperature so that the restart occurs via START&STOP
2. Deactivate the START&STOP with the relative button  and proceed with a new start-up.
3. Change the intended temperature by pressing the  keys.

In this case, the temperature modification screen appears. The equipment will turn on when the setting is higher than the room temperature + the POSITIVE hysteresis.

On the other hand, it remains in STAND BY if the setting is lower than the room temperature + POSITIVE hysteresis and it is not possible to switch on the device, even with the text .







24-START&STOP

WATER TEMPERATURE SETTING

For hydro stoves, it is also possible to adjust the temperature of the water in the boiler/puffer/storage for possibly re-starting the stove by pressing the keys.

In some system configurations, restarting from stand by (which happens by editing the water temperature set) occurs when the temperature - hysteresis conditions are no longer fulfilled (ΔT PUFFER=10°C; ΔT STORAGE TANK =10°C).







Alternatively, for restarting, it is possible to raise the H2O Temp. SET. (Puffer or storage tank) or adjust the external thermostat.

In STANDBY status, pressing the   keys makes it possible to scroll through the various  BOILER/PUFFER/STORAGE/ROOM temperature adjustments with the  key, to possibly edit the set point, also with the stove in STANDBY and possibly turn it back on.

With the ON/OFF key, the stove can be switched off completely also in STANDBY, it can only be turned back on by pressing ON/OFF again.

ACTIVATING START&STOP WITH THE EQUIPMENT OFF

If the equipment is OFF and the START&STOP needs to be activated, the following occurs when the  key is pressed:

- The stove changes from OFF to STAND BY.
 - the house icon becomes  and the  key turns green
 - In any case, the product remains off, however:
 - If the previously set temperature is already lower than the room temperature, the product remains off and the on/off  key turns steady green. The stove will eventually turn on again when the room temperature drops or by modifying the temperature setting, as seen previously, with the   keys.
- Under no circumstances can the product be switched on again when $TSET < ROOM T$.
- **If the previously set temperature is already higher than the room temperature, the equipment remains off but the green  key will start to flash to alert the user that an additional input is required to allow the product to switch on (on/off key pressed for 2").**

EXTRA DISPLAY

In comparison to the standard where the  icon turns green, there are representations where this icon disappears to leave space for other settings such as AUX2 – AUX3 – AUX4.

In this case, the word AUX will turn green, highlighting the fact that START&STOP is active.

In configurations where START&STOP cannot be disabled (see 5 and 6), the key is not active.

25-CHRONO-SLEEP

CHRONO AND SLEEP OPERATION



Press the  key to directly activate the CHRONO or SLEEP function.

The first time the button is pressed, the following appears: **CHRONO OFF**



Use the   keys to select **CHRONO ON**

If the Chrono has been activated, the red  icon appears on the display so that activation of the function is always evident.





Press the  key to disable the CHRONO and access the **CHRONO ON screen**.

Use the   keys to select **CHRONO OFF**.

The second time the button is pressed the following appears: **SLEEP OFF**

Unlike CHRONO, the SLEEP mode sets an **unplanned** switch-off of the product outside the CHRONO programming



Use the   keys to select the time after which you want the product to switch off. You can choose a time between 10 minutes and 8 hours, with 10 minute intervals.





25-CHRONO-SLEEP

The red  icon appears on the display so that the activation of the function is always indicated.



Press the  key twice to deactivate SLEEP and turn on the screen with SLEEP and the remaining time indicated.

Use the   keys to bring the count to 00:00, which corresponds to **SLEEP OFF** (timer at 00:10+, pressing the key once switches to OFF and not to 00:00).

COMBINED CHRONO AND SLEEP ACTIVATION



If the CHRONO and SLEEP modes are both ON, the icon shown is a mix between the two: 

25-CHRONO-SLEEP





ACCESS TO CHRONO PROGRAMMING

To access the chrono programming mode from the panel, press and hold the  key for **5 seconds**.



The screen on the side appears, where it is possible to set:

- o The chrono programs for the days of the week
- o Temperatures T1 / T2 / T3 / T4

Use the   keys to select the menu item and the  OK key to enter the daily programming. Press the  ESC key to return to the previous menu.



The menus are all in English and the language cannot be changed due to how the items are displayed.

CHRONO PROGRAMMING

Select SET CHRONO (see image above) to enter the mode for choosing the day to be programmed.

Use the   keys to select a menu item and use the  SET key to select the item by entering the programming.

Press the  OK key to return to the previous menu, confirming the current weekly programming.

The selectable items are:

- MONDAY
- TUESDAY
- WEDNESDAY
- THURSDAY
- FRIDAY
- SATURDAY
- SUNDAY
- COPY PROG. (copy program)
- MODIFY PROG. (modify program)
- DELETE PROG. (delete program)



Select a day (MONDAY) to access the programming of that day, and a summary of the programming already scheduled for that day is shown. The crown has 48 sectors corresponding to the 24 hours plus the half hours; it is coloured differently according to the temperature programming and whether the chrono is active or not.

In the centre of the crown there is a small key that summarises the colours for the temperatures that can be set in the dedicated menu (see dedicated chapter)

Use the  SET key to enter the programming of a **NEW TIME SLOT** for MONDAY as indicated at the centre of the crown.

If, instead, you wish to confirm the programming as shown and return to the day selection menus (not completely but only by one step), press the  OK key.

To edit or delete the existing slots, return to the main menu and select MODIFY PROG. (MODIFY THE CHRONO PROGRAM).

An example of a crown without a program with all sectors in OFF is shown on the side.

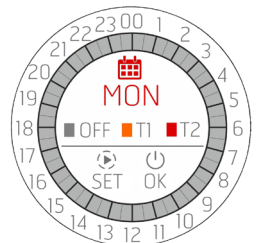

25-CHRONO-SLEEP

TIME SLOT PROGRAMMING

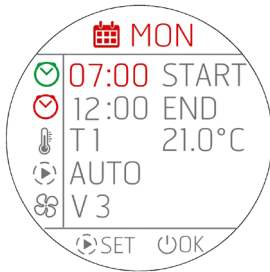

At the start of programming, the first **START** field is coloured red. Use the \oplus \ominus keys to adjust the START time of the chrono slot.

i *Advances are in 30 MINUTE STEPS (00:00 / 00:30 / 01:00...).*

Use the \rightarrow SET key to confirm the selected time and move on to the next **END** setting which in turn lights up in red. The END adjustment is carried out with \oplus \ominus and confirmed with \rightarrow . Then move on to adjusting the desired temperature by setting in this case T1 or T2 or T3 or T4 (T3 and T4 for HYDRO STOVES). The temperature corresponding to T1 or T2 is displayed next to T1 or T2. If instead you wish the stove to be off, select OFF.

T1 or T2 or T3 and T4 cannot be edited on this screen but only from the main screen through SET TEMP.



Continuing with the programming, the mode chosen for that time slot and then ventilation are set. Please note that ventilation can only be selected when programming the AUTO mode. If the COMFORT or OVERNIGHT mode is selected at the ventilation field ∞ , dashes --- will be shown and no modification can be performed.

After adjusting ventilation (only to AUTO) or the mode, you can cyclically continue editing by repeatedly pressing the \rightarrow SET key.

To confirm all the programming and exit the screen, press the \rightarrow OK key, a window will appear asking whether to confirm the time slot (CONFIRM) or to exit without saving (EXIT).

After exiting the screen, you return to the summary screen of the day you are editing (MONDAY) for potential programming of another time slot.

If you wish to confirm all the programming of the day you are programming, press \rightarrow OK again and you will return to the menu for selecting the days of the week (MONDAY, TUESDAY, etc.)



25-CHRONO-SLEEP



- *When setting a new time slot, this can never be spaced out by just 30 minutes, but at least 1 hour is required to give the product time to carry out the entire shutdown cycle. By programming a new time slot, there will therefore be no option to select a time only half an hour after the last shutdown.*
- *It is instead possible to program two specific time slots (as in the graphic representation) as in this case the stove will not switch off but it may be that you only wish to change the temperature SET (from T1 to T2 or vice versa) or the operation (from AUTO to COMFORT for example).*
- *If you set a new time slot that “invades” an existing one, it is assumed that the user wishes to change both, therefore the new time slot will partially or completely overwrite the existing one.*

Example:

EXISTING TIME SLOT:

from 06:00 to 12:00 T1 and AUTO and V3

NEW TIME SLOT BEING ENTERED:

from 04:00 to 09:00 T2 and COMFORT

RESULTING PROGRAMMING:

from 04:00 to 09:00 T2 and COMFORT

from 09:00 to 12:00 T1 and AUTO (V3)

- *If you only wish to delete or modify an existing slot, use the dedicated menu described below*
- *A time slot can never exceed midnight and therefore if you wish continuous night operation, select the END time 00:00 and on the following day set a time slot with a START at 00:00.*

25-CHRONO-SLEEP

PROGRAMMING OF A TIME SLOT IN CASE OF AN EXTERNAL THERMOSTAT

If there is an external thermostat active, obviously there is no option to choose a T1 / T2 / T3 / T4 but it is possible to select only ON/OFF.

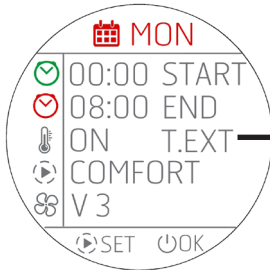

The main programming screen changes as shown on the side:

The temperature field displays ON and T.EXT which identifies that on that specific time slot the thermostat requests power.

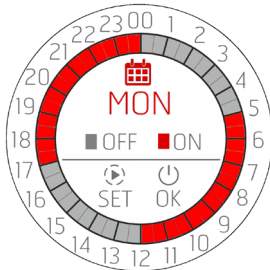

The day summary screen changes as follows:

PROGRAMMING OF THE WHOLE WEEK OR COPY OF THE PROGRAMS

As explained, it is possible to program each individual day of the week but also to copy an **entire daily program to another day**. To do this, select COPY PROG. from the menu.



From this menu select the day you wish to copy and press the SET key. The selected day turns red and after 1" you access the next menu which asks to which days to make the copy. Use the key to instead return to the previous menu, actually confirming the state of the art.



Continuing with the example, if you decide to copy the day MONDAY, the abbreviation of the day you are copying will be indicated in red at the top and under the list of the other days except the one from which you are copying (MONDAY)

You can select one or more days in which to copy the MONDAY program.

Scroll through the list with the keys and use the SET key to select the days in which you wish to make the copy. Pressing the key again selects and de-selects the days.

25-CHRONO-SLEEP

When all the days in which to copy the MONDAY program have been chosen, confirm the operation with the  OK key.



To highlight the operation performed, the screen on the left appears for 3" and you will return to the original screen if you wish to make other copies.





EDITING A DAILY PROGRAM





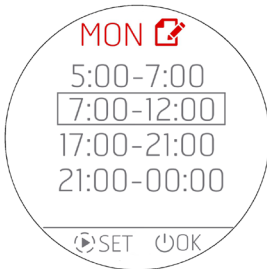

To edit a daily program, select **MODIFY PROG.** in the home menu. The screen used to select the days of the week appears.

 **ATTENTION! The screen icon is the edit  one and not the one for programming  a new slot!!**

Use the  SET key to select the day and move to the screen relating to the existing time slots. If no day is selected, pressing the  OK key basically returns to the previous menu without making any changes.



If instead you access the modification of the time slots as usual with the   keys, you select the program and use the  SET key to select the one you wish to modify. If instead no slot is selected, use the  OK key to basically return to the previous menu without making any changes.



If you wish to modify a time slot, the first request is whether you wish to DELETE or MODIFY the time slot through this menu:

If you wish to delete the time slot, you will access this double confirmation screen and if so, the time slot is deleted and you return to the previous menu where all the time slots of the day MONDAY are shown, obviously without the one just deleted.



25-CHRONO-SLEEP

MODIFYING THE TEMPERATURES T1 / T2 / T3 / T4

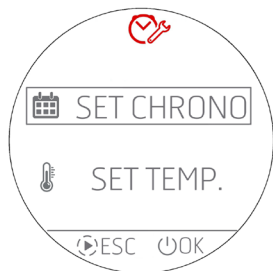

To set the temperatures of SET T1 – T2 – T3 – T4 (T3 and T4 only for Hydro stoves) you must enter the menu **SET TEMP.** selecting the item with the \oplus \ominus keys and confirming with the OK key.

Press the ESC key \leftarrow instead to return to HOME

By accessing the temperature modification menu, the following settings can be viewed.

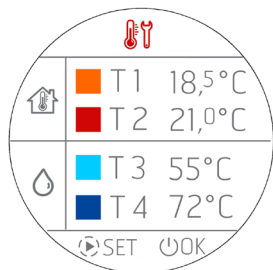

By pressing the \leftarrow SET key, the first temperature (T1) becomes RED and the \oplus \ominus keys can be used to proceed with the modification in steps of 0.5°C. As usual, a prolonged pressure of the \oplus \ominus keys results in temperature variations in higher steps, following the same philosophy of the temperature changes on the panel.

Pressing the \leftarrow SET key again proceeds with the modification of the second temperature (T2) which in turn becomes RED. This process continues for all temperatures or until the \leftarrow SET key is pressed.

To confirm and exit the screen, press the OK key.



PLEASE NOTE In case of an AIR stove, temperatures T3 and T4 either do not appear or they remain unchangeable.

25-CHRONO-SLEEP

CHRONO VARIANT FOR HYDRO STOVES

MANAGEMENT OF T3 AND T4

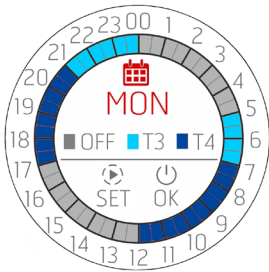

If T3 and T4 temperatures are selected, the summary display simply changes colour and the key is updated since it is not possible to set the chrono slot where both the AIR temperatures (T1 and T2) and the WATER temperatures (T3 and T4) are present simultaneously. When temperatures T3 and T4 are selected in the programming, the representation of the day will take the colours of T3 and T4.

PROGRAMMABLE PARAMETERS IN THE TIME SLOT

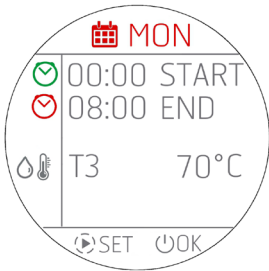

With respect to AIR products, there are fewer possible settings which are only START, END and the water temperature in the puffer/boiler. As there is no option to set modes and ventilation, these parameters disappear.

26 - WI-FI/WPS/BLUETOOTH

ENABLING/DISABLING BLUETOOTH

BLUETOOTH is independent from the WI-FI and is enabled by pressing $\oplus \ominus$ simultaneously and continuously for 5 seconds

Pairing is enabled during activation and when you return to the home screen, the icon appears and flashes waiting for connection with an **already registered device**.

The Bluetooth connection is not deactivated but is always waiting for a connection (with devices that are already registered), so that if a paired device is within range at different times of the day, it automatically connects to the product (just like a mobile phone when entering the car).

Press $\oplus \ominus$ for 5" to disable Bluetooth.

If WIFI has already been enabled, both function simultaneously, otherwise only Bluetooth will be active.

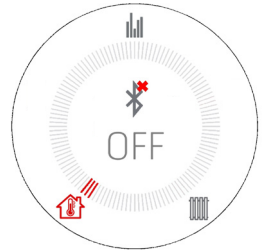

BLUETOOTH AND WI-FI DISPLAY

Bluetooth only is ON and waiting for a connection with devices that are already registered	Bluetooth only is ON and connected (blue icon)
WI FI is ON and connected and Bluetooth is waiting for a connection with devices that are already registered	WI FI is ON and connected and Bluetooth is connected (blue icon)

FIRST BLUETOOTH CONNECTION

As is the norm for Bluetooth connections, search for the Bluetooth network of the equipment on the device (smartphone), indicated on the product label.

26 - WI-FI/WPS/BLUETOOTH

ENABLING/DISABLING WI-FI and WPS

By default, the product has Bluetooth network enabled and Wi-Fi active but not connected: this means that Wi-Fi is not visible until the product is connected to a Wi-Fi/home network.

WI-FI MENU:

Open the specific menu on the panel by simultaneously pressing the $\oplus \ominus$ keys.

Depending on the connection status, you can select:



- "OFF": when Wi-Fi is connected to a home network that has already been set up and can be switched off by interrupting the product's connection to the network.
- "ON": when Wi-Fi has already been switched off and switches back on trying to connect to the previous network used for the connection. It is only visible and selectable if it is not connected to a network.
- "WPS": when Wi-Fi has never been connected to any network or it has been reset, then the procedure can be activated to connect the product.
- "RESET": regardless of the Wi-Fi status, this disconnects the product from the network and/or deletes the saved network if present.

When the intended option is selected on the menu, the chosen option appears in full screen for 3" and then returns to the display prior to the $\oplus \ominus$ keys being pressed.

The selection menu has a timeout of 60". If no selection or confirmation is made with the ON/OFF key, everything remains unchanged as at the moment prior to pressing $\oplus \ominus$.

When Wi-Fi is active and connected to a router or similar, the  symbol remains indicated inside the crown.

The symbol also indicates the strength of the Wi-Fi signal by removing or adding lines to the symbol to indicate a change in signal strength, according to this diagram:

	LOW POWER		MEDIUM POWER		MAXIMUM POWER		APP CONNECTED TO THE NETWORK BUT NOT TO THE STOVE
--	-----------	---	--------------	---	---------------	---	---

There are two ways to connect the product to the Wi-Fi network:

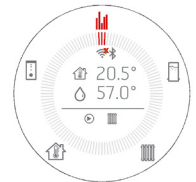

- WPS function
- With the APP (Android or IOS) via Bluetooth connection



WPS CONNECTION

Open the specific menu on the control panel by simultaneously pressing the $\oplus \ominus$ keys and select "WPS" (the menu can be opened with the product on or off).

When WPS is activated, the  icon turns red and always flashes for the expected connection duration (2 minutes).

If the procedure is successful, the  symbol remains steady, otherwise after the WPS timeout, the  symbol disappears.

CONNECTION BY APP (ANDROID OR IOS) VIA BLUETOOTH CONNECTION

To connect to a home network, first ensure that the Bluetooth connection is on.

When the APP starts up the first Bluetooth connection screen appears, press the "+" box to add a new device.

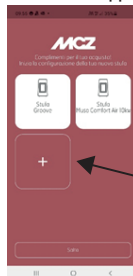

26 - WI-FI/WPS/BLUETOOTH

The APP will search for available devices close by. It is possible that not only the Bluetooth network of the stove is found, but also that of other appliances; the stove is uniquely identified by the name MCZ_EP_123456, where the last 6 numbers are the last 6 digits of the stove's serial number which can be found on the appliance's label or in the instruction leaflet.

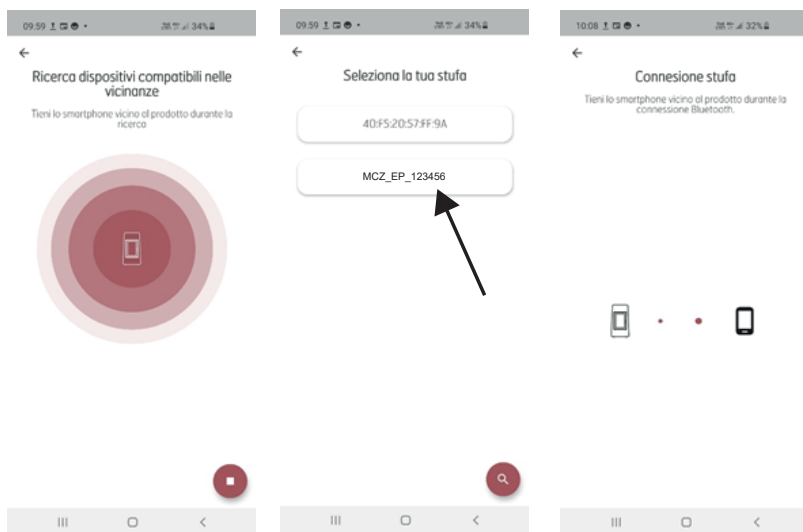

When the product is connected via BLUETOOTH, the APP will display a list of available home networks whose login details must be entered.

Once the network has been selected, the data of the stove being connected are given. Pressing the NEXT key starts the network connection procedure which identifies all the steps that have been successful or have failed.

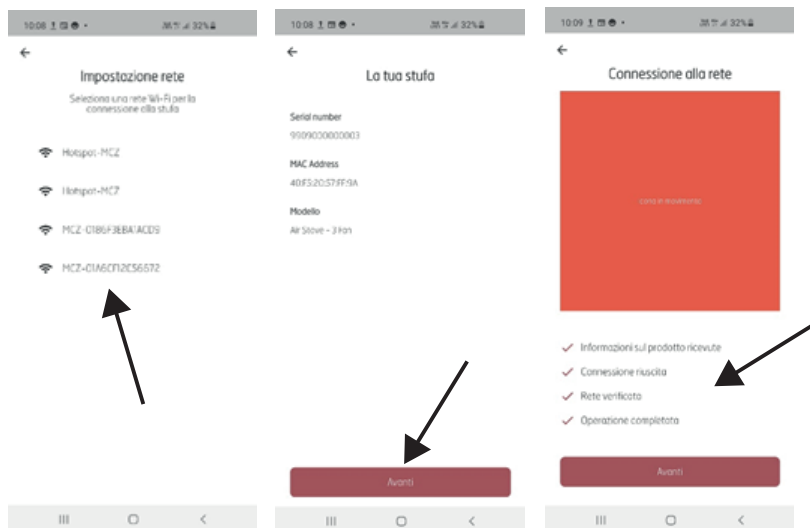







If the whole procedure is correct, press the NEXT key to start interacting remotely with the appliance via Wi-Fi.

27-SHUTDOWN







SHUTDOWN (in various states)



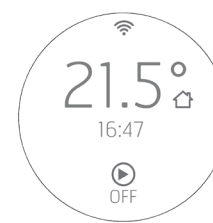



Just like switch-on, press and hold  for 2" and the display will switch to OFF/stand-by mode.

OFF display.

- Room temperature
- Current time
- OFF
- The  icon is only present if the product is connected to a router; otherwise it is off and the  icon is present if Bluetooth has been enabled.
- In the shutdown state, the  key changes colour according to the shutdown stage:
 - FLASHING Red: First shutdown stage.
 - FLASHING blue: Cooling stage and the  icon appears on the display and the  button flashes blue. If the equipment has a self-cleaning brazier, the brazier cleaning icon  appears during the cooling stage
 - STEADY white: Cold product in stand by and OFF appears on the display
 - STEADY green: Product OFF from START&STOP and waiting for input.

NOTE: If the pump is still running, the pump icon will remain on the screen in stand by







			
RED ICON	RED ICON	BLUE ICON	BLUE ICON
			
SHUTDOWN	SHUTDOWN WITH PUMP RUNNING	BRAZIER SCRAPING (MATIC STOVES)	COOLING

		
WHITE ICON	GREEN ICON	RED ICON
		
OFF	OFF BY ECOSTOP	OFF BY ALARM

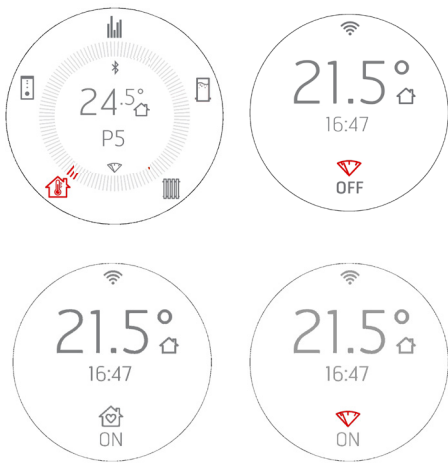

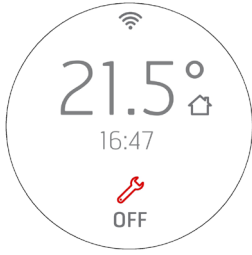

28-EXTRA DISPLAYS

MANAGING OTHER NOTIFICATION ICONS

The following are other notification icons that must appear on the panel:

 <p>The pellet reserve icon appears if the specific sensor (optional) is installed. The symbol appears inside the crown when the pellet level drops below the sensor: grey during operation and red in OFF or STAND BY for START&STOP The icon does not appear during shutdown and cooling</p> <p>If the panel is in STANDBY, the reserve icon is displayed alternately with the icon that indicates the operating mode (or SILENT MODE) with an interval of 10 seconds each.</p>	
 <p>The red  icon indicates that the maximum number of working hours has elapsed, beyond which unscheduled maintenance is required (e.g. 2000 working hours). It appears in the STAND-BY and OFF screen (PRODUCT OFF or OFF FOR START&STOP) The icon does not appear during shutdown and cooling.</p>	
 <p>Self-cleaning brazier cleaning</p> <p>The icon appears after the shutdown and before the cooling stage in the case of products equipped with a self-cleaning brazier. The icon appears throughout the brazier handling cycle.</p>	
<p>FEED SCREW AUTOMATIC RELEASE</p>  <p>YELLOW ICON</p>	<p>If the ON-OFF key turns yellow during operation, it means that the feed screw is performing a rotation cycle in the reverse direction to release some pellets in it. The cycle is automatic and there is no need for user intervention.</p>

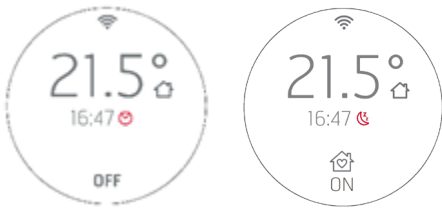
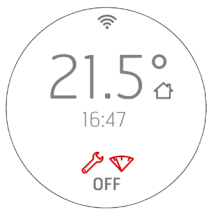
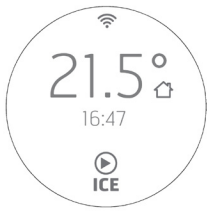
28-EXTRA DISPLAYS



 <p>COOLING ICON</p> <p>Display in COOLING status after shutdown.</p>	
 <p>CHRONO and SLEEP</p> <p>Example of the CHRONO/SLEEP icon display when OFF and of the CHRONO with STAND BY display and product ON. The icons are red.</p>	
<p>Example of displaying several icons in OFF or STAND BY for START&STOP.</p> <p>In this case, the icons are all red</p>	
<p>Stove off with pump ON because the system temperature is below 5°C and it starts automatically with anti-freeze function</p>	
<p>Stove off due to safety temperature reached in the boiler. DWN will appear, indicating shutdown due to cooling (the pump is ON)</p>	

29-USER MENU

USER MENU

Pressing the  button continuously for 5" grants access to a user menu scrolled with the   buttons.

The TIME OUT to exit this screen is 2 minutes, unless you forcibly exit with .

The selection box indicates the item you are selecting and moves with  .

Press  to select the menu item.











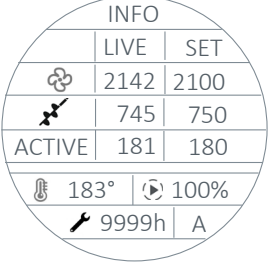







Press  to confirm your choices and exit.

The user menu has the following items:

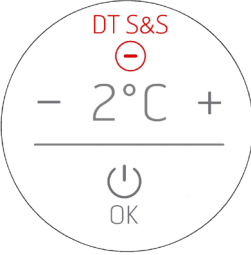
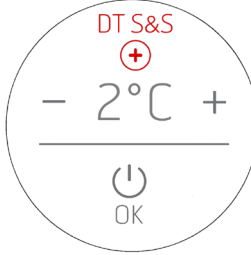

- INFO = Display of the most important operating parameters
- SW/FW: Display of SW/FW versions
- DATE AND TIME= date and time settings
- NTC 1: room probe or room thermostat
- NTC 2: NTC2 probe status display (puffer HIGH probe) as entered in the INSTALLATION SET menu. The output can be a dry contact (T.EXT); in this case, ON/OFF will appear instead of the temperature.
- NTC 3: NTC3 probe status display (STORAGE TANK probe) as entered in the INSTALLATION SET menu. The output can be a dry contact (T.EXT); in this case, ON/OFF will appear instead of the temperature.
- It can also be used as the average temperature reading probe for the puffer (T.MED) with INSTALLATION SET 5-6.
- AUX : Configuration of the rear terminal outputs (contacts 7-8-9) based on 4 different uses:
 - o OFF = Not enabled- DEFAULT of all system configurations
 - o AUX 1 = Remote Alarm.
 - o AUX 2 = Puffer Pump.
 - o AUX 3 = Contact at temperature
 - o AUX 4 = Thermostatic contact.
- PURGE - To start, from the menu, the function to purge air bubbles from the system
- MAX POWER - To set the maximum power in case of "call" by a probe/thermostat
- WINTER/SUMMER: WINTER/SUMMER heating period adjustment. The 3-way valve is always set to DHW for SUMMER
- INSTALLATION SET = Menu to quickly set the type of system from the panel. The settable items refer to the system number. There are 6 possible choices:
 - o 1. HEATING
 - o 2. HEATING WITH DHW (DOMESTIC HOT WATER)
 - o 3. STORAGE TANK WITH THERMOSTAT WITH TERMINAL BLOCK POSITION 5-6
 - o 4. STORAGE TANK WITH NTC PROBE WITH TERMINAL BLOCK POSITION 5-6
 - o 5. PUFFER WITH THERMOSTAT WITH TERMINAL BLOCK POSITION 1-2
 - o 6. PUFFER WITH NTC PROBE WITH TERMINAL BLOCK POSITION 1-2
- ΔT START&STOP= POSITIVE and NEGATIVE hysteresis setting for START&STOP operation
- CLEAN GRATE control to open and close the self-cleaning brazier (only MATIC products)
- ADAPTIVE MODE = ON/OFF (default OFF)
- TONE:
 - o SILENT: light BEEP only upon confirmation of commands
 - o NORMAL: BEEP only audible upon confirmation of commands (FACTORY SETTING)
 - o HIGH: BEEP audible every time the button is pressed
- BRIGHTNESS = option to adjust the display contrast
- DISPLAY SET = option to adjust the centring of the display
- STANDBY DISPLAY = It is used to adjust the time after which the display goes into Stand by (see the previous paragraph). Adjustment in seconds with a prolonged press of the keys in 5" steps (default is 120"). Limit is 600" (10 minutes). Pressing the key again after 600" brings the standby to OFF, i.e. the standby screen never appears when ON

29-USER MENU

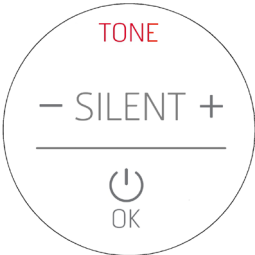
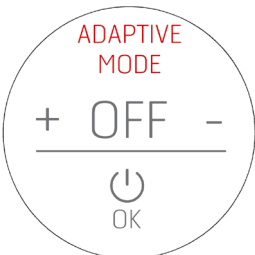

CONTROLS

DISPLAY	CONTROLS
<p>INFO</p> 	<p>Read-only Key  or  to exit (+beep) The TIME OUT of this screen is 2 minutes</p>
<p>DATE AND TIME</p> 	<p>Once you have entered the menu, the day turns red to indicate where the adjustment of the values begins. The   buttons and  are lit, indicating which keys are enabled for adjustments whereas the others are disabled. Use the   keys to choose the day and  to confirm and move on to the month setting, which in turn turns red. Use the same method to then set the current year. Pressing the  key again moves on to setting the time. The hours turn red. Adjust the hours with   and confirm with  and move on to set the minutes. The same procedure applies to set the minutes. When the  key is pressed to confirm the minutes, all the characters become grey again; wait 3" to have a general view of the adjustments made and exit the menu and return to the display shown before accessing the menu. The date and time can both be adjusted with the product ON and OFF (or when first started up).</p>
<p>ΔT START&STOP (POSITIVE AND NEGATIVE HYSTERESIS)</p> <div style="display: flex; justify-content: space-around; align-items: center;"> <div data-bbox="98 1056 349 1311">  </div> <div data-bbox="389 1056 640 1311">  </div> <div data-bbox="663 1088 1050 1232"> <ul style="list-style-type: none"> •   to change the values • The available values from +5 to -5 •  to confirm and return to the previous page (+beep) •  to exit without confirming (+beep) </div> </div>	

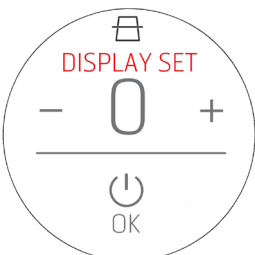



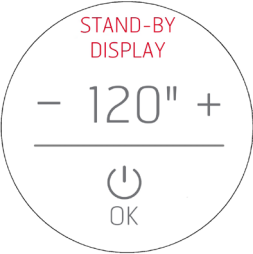





29-USER MENU

<p>TONE</p> 	<ul style="list-style-type: none"> • $\oplus \ominus$ to change the values • Available values – SILENT / NORMAL / HIGH • \odot to confirm and return to the previous page (+beep) • $\odot \rightarrow$ to exit without confirming (+beep) <p>NORMAL is the factory setting</p>
<p>ADAPTIVE MODE</p> 	<ul style="list-style-type: none"> • $\oplus \ominus$ to change the values • The available values -ON and OFF • \odot to confirm and return to the previous page (+beep) • $\odot \rightarrow$ to exit without confirming (+beep) <p>By activating the function (select ON), the stove adapts its operation in case of special installations or when using poor quality pellets.</p> <p>The following are some examples of when it is recommended to activate the function:</p> <ul style="list-style-type: none"> • formation of combustion residue • formation of condensate in the flue when operating at minimum power • improve cleaning of the glass when operating at minimum power
<p>BRIGHTNESS</p> 	<ul style="list-style-type: none"> • $\oplus \ominus$ to change the values • The available values -3 -2 -1 0 + 1 +2 +3 • \odot to confirm and return to the previous page (+beep) • $\odot \rightarrow$ to exit without confirming (+beep)
<p>DISPLAY SET</p> 	<ul style="list-style-type: none"> • $\oplus \ominus$ to change the values • The available values -3 -2 -1 0 + 1 +2 +3 • \odot to confirm and return to the previous page (+beep) • $\odot \rightarrow$ to exit without confirming (+beep)

29-USER MENU

<p>STANDBY DISPLAY</p> 	<ul style="list-style-type: none">• to change the values• The available values from 0 to 600". The next step after 600" is OFF, which means that the display NEVER goes into standby.• to confirm and return to the previous page (+beep)• to exit without confirming (+beep)
<p>CLEAN GRATE (only MATIC and HYDRO)</p> 	<p>The function can only be activated with the stove off.</p> <ul style="list-style-type: none">• to change the values• The available values -ON-OFF (OPEN/CLOSED)• to confirm and return to the previous page (+beep)• to exit without confirming (+beep)

29-USER MENU

<p>NTC 1</p> 	<p>Room probe - terminal block position 3-4</p> <ul style="list-style-type: none"> •  to change the values • Available values -ON-OFF-T.EXT •  to confirm and go back to the previous page (+beep) •  to exit without confirming (+beep) <p>With INSTALLATION SET 5 and 6 configuration, NTC1 is at OFF because only the call to the water temperature from the puffer counts.</p>  <p>It can be activated through menu - NTC1 - ON: in this case only the Room T is displayed See the AUX1 menu for other functions.</p>
<p>NTC 2</p> 	<p>Puffer probe - terminal block position 1-2</p> <ul style="list-style-type: none"> • Displayable values -ON-OFF-T.EXT as set in the INSTALLATION SET configuration
<p>NTC 3</p> 	<p>Storage tank probe - terminal block position 5-6</p> <ul style="list-style-type: none"> • Displayable values -ON-OFF-T.EXT as set in the INSTALLATION SET configuration <p>Can be activated with system 5-6 to view T med puffer</p> <ul style="list-style-type: none"> •  to change the values • Available values -ON-OFF-T.EXT •  to confirm and go back to the previous page (+beep) •  to exit without confirming (+beep)

AUX



- \oplus \ominus to change the values
- Available values -OFF-1-2-3-4
- \odot to confirm and go back to the previous page (+beep)
- \odot to exit without confirming (+beep)

AUX = Configuration of the 230V output of the rear terminal 10/11/12 based on 4 different uses:

OFF = Not enabled- DEFAULT of all system configurations. In this case, by standard, the view of the display on the first row is based on what is selected for NTC1

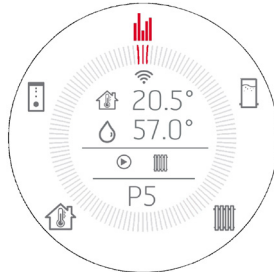

AUX 1 = Remote Alarm. In case of alarm by the stove, reverse the status of the relay on contacts 7/8/9. The display on the first row, by standard, is based on what is selected for NTC1, even if this setting remains enabled in the background

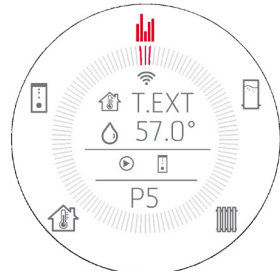
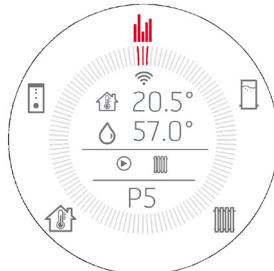

AUX 2 = Puffer Pump can be activated in INSTALLATION SET 5 and 6 configuration. Remote control with external pump based on the room temperature that can be adjusted from the panel. If the room temperature is fulfilled, the status of the 3-way valve changes, which brings current to connector 10/11/12.

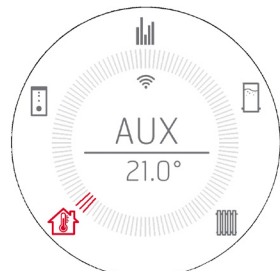
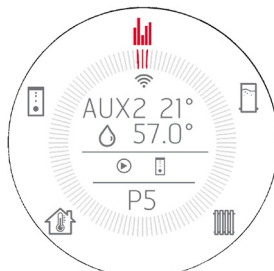

If T.EXT is activated on the NTC1 menu, it has the same function as the NTC1 but obviously ON/OFF will appear on the display

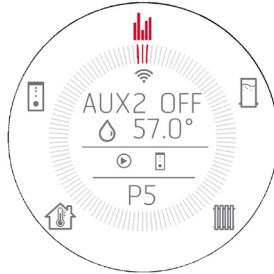

AUX 3 = Contact at temperature. This is the desired water temperature, outside of which the status of the relays on contacts 7/8/9 changes.

It can be used to give consent to a heat generator external to the stove. Up to the entered threshold (30 - 60 range) the heat generators can work together, when the set is reached the relay status changes.

With system configuration 1/2/3/4 the display on the first row varies based on the selection for NTC1 and the AUX3 setting remains enabled in the background.

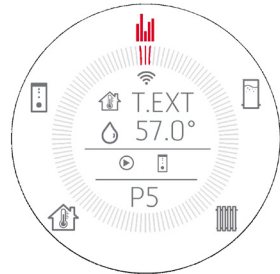
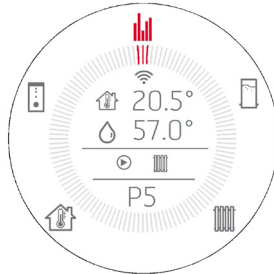

On the other hand, for system 5/6 configuration, the display can be the following, as NTC1 is no longer active

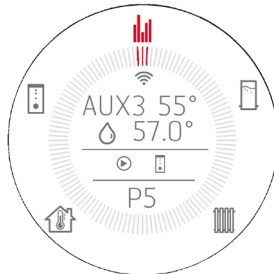

The AUX3 set temperature can be adjusted directly with the activation of this setting, according to the following sequence:





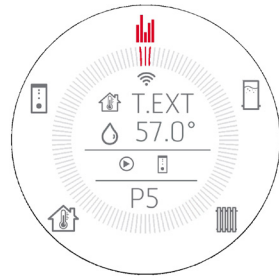
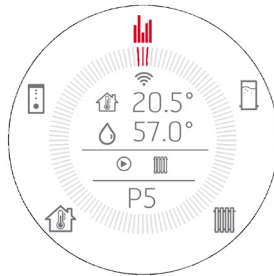



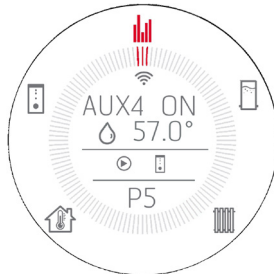

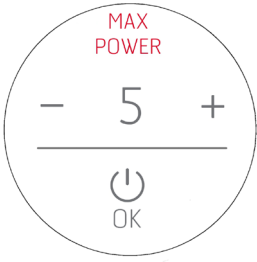

AUX 4 = Status contact. Relay position 7/8/9 changes based on whether the stove is in alarm/off/not powered. In this case another heat generator can intervene to heat the system. The display on the first row, by standard, is based on what is selected for NTC1, even if this setting remains enabled in the background.



WITH CONFIGURATION 5 and 6



29-USER MENU

<p>MAX POWER</p> 	<p>Function to set the maximum power in case of a heat request by a probe/thermostat:</p> <ul style="list-style-type: none"> •  to change the values • Available values -1-2-3-4-5 (DEFAULT 5) •  to confirm and go back to the previous page (+beep) •  to exit without confirming (+beep)
<p>WINTER/SUMMER</p> 	<ul style="list-style-type: none"> •  to change the values • Available values - WINTER / SUMMER •  to confirm and go back to the previous page (+beep) •  to exit without confirming (+beep)
<p>INSTALLATION SET</p> <p>These screens are used to set the systems according to the defaults required by the specification. With the choice of the system, the inputs/outputs, Start&Stop etc. ...are activated/deactivated respectively</p> <p>The information on the screens refers to the settings that will be implemented by activating the configuration.</p> <p>In some configurations, it is possible to activate/deactivate the inputs and outputs individually as seen in the menus above, but any of these changes will NOT appear on these screens because they represent the default settings of configuration 1/2/3/4/5/6</p> <p>When you access the INSTALLATION SET MENU, you access the active screen (upon first installation it will be the default one).</p> <ul style="list-style-type: none"> • In the BOX on the left-hand side of the active configuration number - The system type will be represented with an image at the top (radiator - radiator/DHW - radiator/storage tank etc...) • In the centre, all of the settings that will be applied • At the bottom, the selection confirmation key. <p>Controls:</p> <ul style="list-style-type: none"> •  to change the values <p>Available values 1 - 2 - 3 - 4 - 5 - 6</p> <p>Default INSTALLATION SET 1 with HYDRO DATABASE or INSTALLATION SET 2 with HYDRO DHW DATABASE</p> <ul style="list-style-type: none"> •  to confirm and go back to the previous page (+beep) •  to exit without confirming (+beep) 	

29-USER MENU

Views based on the selected system:

HEATING CONFIGURATION	DHW CONFIGURATION	STORAGE TANK WITH THERMOSTAT CONFIGURATION
STORAGE TANK WITH PROBE CONFIGURATION	PUFFER WITH T.EXT. CONFIGURATION	PUFFER WITH PROBE CONFIGURATION

To differentiate whether the storage tank/puffer is controlled by the internal probe or by the external thermostat, the thermometer was placed respectively inside or outside the storage tank/puffer icon.

The NTC values can be OFF / ON / T.EXT where ON means that the NTC is a probe, whereas T.EXT is a thermostat.

On the other hand, as for NTC 1, the possibilities are OFF/ON/T.EXT where AUX makes it possible to control the temperature with an external NTC. With this setting, the stove does not modify its power if the temperature is reached or not, rather it only gives consent for external use through terminal 7/8/9. This configuration is possible when configuration 5/6 is set, where the stove is controlled by the puffer and the stove can control, for example, an external pump at temperature.

PURGE

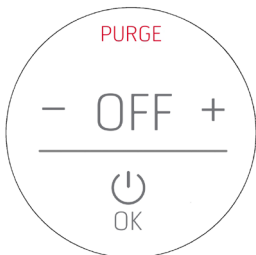

- to change the values
- Available values -ON-OFF
- to confirm and go back to the previous page (+beep)
- to exit without confirming (+beep)





This is to activate the system purge function.

29-USER MENU

AUSSENTHERMOSTAT (see NTC1 user menu)

If an external thermostat is connected, it is no longer possible to indicate the room temperature recorded by the local probe and adjust the intended temperature from the panel.

The view on the display will therefore be the following:

	
<p>ON indicates that the thermostat contact is CLOSED and there is a power demand. Therefore the product will run at maximum power until the temperature is reached and then it will reduce its operation to minimum.</p>	<p>OFF indicates that the thermostat contact is OPEN and there is NO power demand. Therefore the stove will run at minimum until the temperature drops below the temperature set on the external thermostat.</p>
	
<p>ON indicates that the thermostat contact is CLOSED and there is a power demand and therefore the stove will run at maximum power until the temperature is reached and it will then turn off according to the START&STOP logics. In this case, since the temperature hysteresis cannot be managed (managed by the external thermostat), the reaction times for restarting or switching off from START&STOP are only linked to the INPUT/OUTPUT delays from the status (see Chap. START&STOP).</p>	<p>OFF indicates that the thermostat contact is OPEN and there is NO power demand and therefore the stove will run at minimum power until the START&STOP INPUT time is satisfied. In this case, since the temperature hysteresis cannot be managed (managed by the external thermostat), the reaction times for restarting or switching off from START&STOP are only linked to the INPUT/OUTPUT delays from the status (see Chap. START&STOP).</p>

30-PELLET LEVEL SENSOR

ASSEMBLING PELLET LEVEL SENSOR (optional)

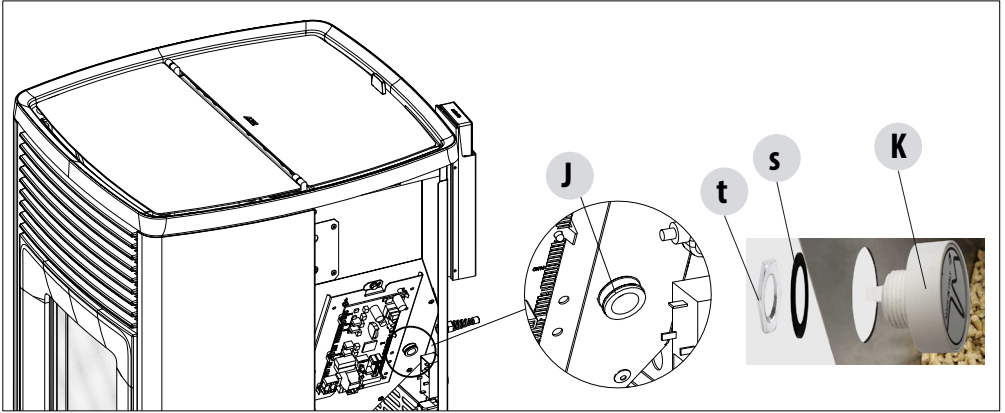

The pellet sensor is a low fuel indicator that warns the user that the pellets are finishing. With the hopper empty, lift the pellet loading cover and manually remove the cap "J" fitted inside, then insert the pellet level sensor "K" from inside the hopper.

The sensor is locked to the tank by externally mounting the seal "s" and firmly securing it with the ring nut "t".

The sensor must then be connected to position 23 on the circuit board with the cable supplied.

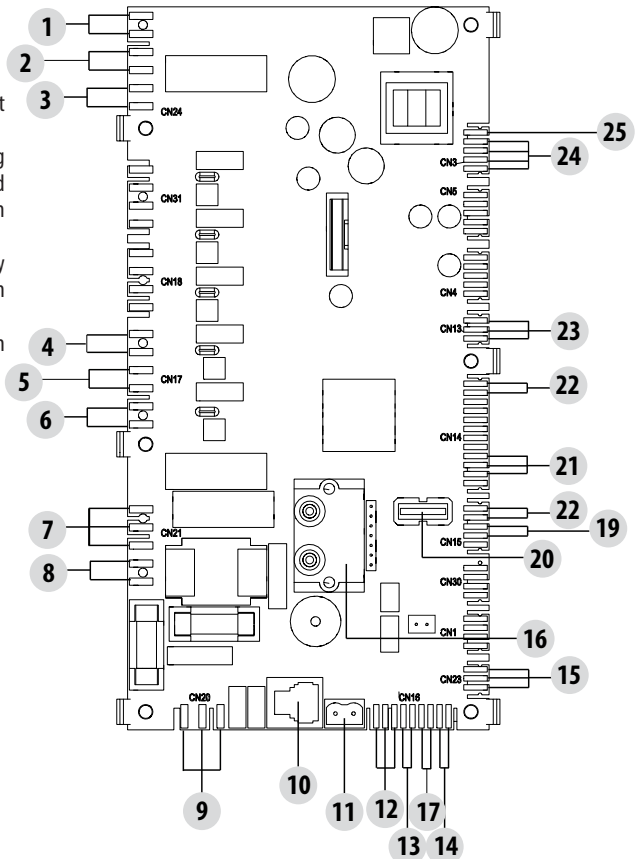
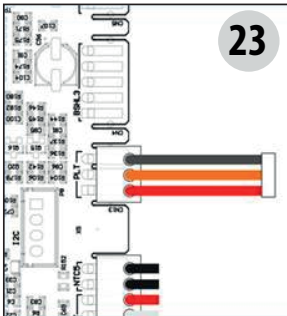

31-CONNECTIONS

- **Puffer thermostat**

To activate this option, connect a Normally Open (N.O.) contact thermostat to points 1 and 2 of the back 9 pole terminal board. Even with this configuration the purpose of the room probe on the stove is only to control the heating system pump controlled by the potential free contact on terminals 7-8-9.

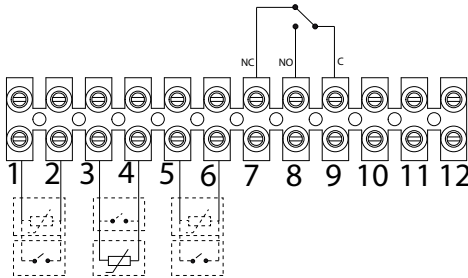

Connections table.

TERMINAL NO.	NAME ON BOARD	FUNCTION
1-2	NTC2	HIGH PUFFER PROBE - PUFFER THERMOSTAT
3-4	NTC1	ROOM PROBE - ROOM THERMOSTAT
5-6	NTC3	STORAGE TANK PROBE - STORAGE TANK THERMOSTAT- MEDIUM PUFFER PROBE
7-8-9	AUX RELAY (Potential-free-contact -Maximum contact voltage - 24V AC/DC)	7 - NORMALLY CLOSED 8 - NORMALLY OPEN 9 - COMMON
10-11-12	3-WAY RELAY (Mains voltage contacts)	POS.10 - DHW (F) POS.11 - COMMON (N) POS.12 - HEATING (F)

To access terminal block "W", remove the cap as reported in part 1 of the manual (in the paragraph devoted to the removal of the back panel).

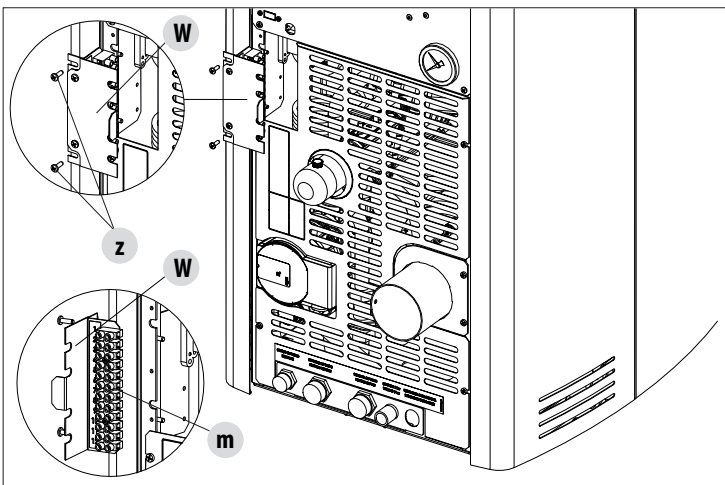

Then loosen the two screws "z" and take out terminal block "W". Perform the necessary connections and place everything back.

The NTC probes must be 10 K Ω B3435, the thermostats must have a dry contact.

32-SAFETY DEVICES AND ALARMS

SAFETY DEVICES

The product is fitted with the following safety devices

ACTIVE +

Besides adjusting the stove operation, it also guarantees that the pellet loading auger is blocked if unloading or there is significant back pressure.

SMOKE TEMPERATURE PROBE

Detects the temperature of the smoke, thereby enabling start-up or stopping the product when the temperature drops below the preset value.

CONTACT THERMOSTAT IN THE FUEL HOPPER

If the temperature exceeds the preset safety level, it immediately shuts down the running of the stove.

WATER THERMOSTAT

If the temperature exceeds the preset safety level, it immediately shuts down the running of the stove.

WATER TEMPERATURE SENSOR

When the water reaches the stop temperature (85°C) the probe automatically instructs the boiler to carry out automatic "OFF Stand-by" shut-off.

ELECTRICAL SAFETY

The stove is protected against violent changes in current by a general fuse located in the control panel at the back of the stove. Other fuses that protect the circuit boards are located on the latter.

SMOKE FAN

If the fan stops, the electronic board shuts off the supply of pellets in good time, and an alarm message is displayed.

GEAR MOTOR

If the reduction motor stops, the stove will continue to run until the flame goes out due to lack of fuel and until a minimum level of cooling is reached.

TEMPORARY POWER CUT

When a power cut is less than 10" the stove returns to its previous operating state; if it is more, it executes a cooling/re-ignition cycle.

FAILED START-UP

If during ignition no flame develops, the stove will go into alarm condition.

ANTI-FREEZE FUNCTION

If the probe in the boiler detects a water temperature of less than 5°C, the circulation pump is automatically activated to keep the system from freezing.

PUMP ANTI-SEIZURE FUNCTION

If the pump is not used for prolonged periods, it is activated periodically for a few seconds to keep it from seizing up.

32-SAFETY DEVICES AND ALARMS



TAMPERING WITH THE SAFETY DEVICES IS PROHIBITED

If the stove is NOT used as described in this instruction booklet, the manufacturer refuses to accept any responsibility for damage to persons and property that may arise. The manufacturer furthermore refuses to accept responsibility for damage to persons and property arising from the failure to observe all the rules contained in the manual and in particular:

- All the necessary measures and/or precautions must be adopted when performing maintenance, cleaning and repairs.
- Do not tamper with the safety devices.
- Do not remove the safety devices.
- Connect the stove to an efficient smoke extraction system.
- First, check that the environment where it is to be installed is properly ventilated.



Only after eliminating the cause of the intervention of the safety system is it possible to re-ignite the stove and thus restore its automatic operation. This manual will help you understand which anomaly has occurred, and explain how to intervene according to the alarm message displayed on the stove.

ALARMS

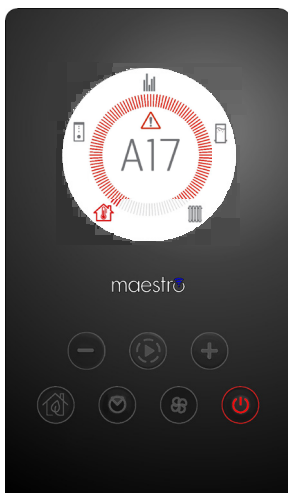

In the event of an alarm, the crown turns red for "attention".

The  symbol and the alarm code appear.

The  button turns red and flashes very fast

All other keys are disabled.

PLEASE NOTE Press the  button for at least 3" to reset the alarm.

32-SAFETY DEVICES AND ALARMS

ALARM ALERTS

If there is an operational anomaly, the stove enters the alarm phase displaying the problem that has taken place through a code, a brief description of the alarm type and an acoustic warning.

The following table describes the possible alarms indicated by the stove, associated to the respective code that appears on the panel and helpful tips to solve the problem.

MESSAGE ON DISPLAY	TYPE OF PROBLEM	SOLUTION
A01 NO IGNITION	The fire does not ignite. (without acoustic alarm)	Check the level of pellets in the hopper. Check that the brazier is correctly positioned in its seat and has no deposits or unburnt material. Make sure the glow plug warms up. Thoroughly empty and clean the brazier before restarting.
A02 NO FLAME	The fire goes out abnormally. (without acoustic alarm)	Check the level of pellets in the hopper. Check that the brazier rests correctly in its seat and has no visible deposits of unburnt pellets.
A03 SAFETY PLT (SIC1)	Pellet hopper temperature too high	The structure is too hot because the product has been used for too long at the maximum power or there is poor ventilation. When the stove is sufficiently cold, clear the alarm on the stove panel or via app. Once the alarm is cancelled, the product can be switched on normally.
A04 FLUE GAS TEMPERATURE	The temperature of the exhaust smoke has exceeded certain preset safety limits.	The stove switches off automatically. Let the stove cool down for a few minutes and then switch it on again. Check the smoke expulsion and verify the type of pellet used according to the instructions found in Chap. 2 of this manual. If the alarm persists, contact the service centre.
A05 OBSTRUCTION	Flue clogged - wind.	Check the smoke duct.
	The smoke extractor fails to guarantee sufficient primary air, required for correct combustion.	Draught difficulties or clogged brazier. Check whether the brazier is clogged and clean it, if necessary. Check, and if necessary clean, the smoke duct and the air inlet.
A08 SMOKE FAN	Abnormal operation of smoke fan	Check cleanliness of the smoke fan compartment and check if dirt is blocking it. If this is not enough, the smoke fan is faulty. Contact an authorised service centre to have it replaced.

32-SAFETY DEVICES AND ALARMS

MESSAGE ON DISPLAY	TYPE OF PROBLEM	SOLUTION
A09 GAS SENSOR	The smoke probe is faulty and does not detect the exhaust smoke temperature properly	Contact an authorised service centre to have the component replaced.
A11 GEAR MOTOR	Feed screw gear motor fault.	The component is not working regularly. Contact an authorised service centre to have the component checked and, if needed, replace the component.
A12	Faulty gear motor driving sensor (PWM)	Contact an authorised service centre.
A13 TEMPERATURE SHEET	Circuit board overheating	The structure is too hot because the product has been used for too long at the maximum power or there is poor ventilation. When the stove is sufficiently cold, clear the alarm on the stove panel or via app. Once the alarm is cancelled, the product can be switched on normally.
A14 ACTIVE SENSOR	Active sensor anomaly	Active Plus sensor operation anomaly. This alarm blocks the stove and can be reset from the App. If the sensor is faulty, the alarm appears once again. Contact an authorised service centre to have the component replaced.
A17	Blocked feed screw due to clogged pellets or a foreign body	The feed screw is not unblocked even after the feed screw unblocking procedure indicated by the software has been carried out (rotating the gear motor in both directions). Try to remove the pellets and/or foreign body with an extractor or call an authorised service centre to perform this operation.
A18 WATER THERMOSTAT SAFETY DEVICES (SIC2)	Tripped safety devices	Water temperature is too high or thermostat operation anomaly. Water pressure too low. Tripped air pressure switch: check the pressure of the hydraulic system. Make sure the pellet tank and door are closed. If the alarm persists, contact the service centre.
A19 WATER SENSOR	Water probe failure	Possible fault in the safety component. Contact an authorised service centre to have the component checked and, if needed, replace the component.

32-SAFETY DEVICES AND ALARMS

MESSAGE ON DISPLAY	TYPE OF PROBLEM	SOLUTION
A20 AUX PROBE	Auxiliary probe failure	Possible component fault. Check that the probe inserted in the system respects the characteristics specified in the instructions (see external probe). Contact an authorised service centre to have the component checked and, if needed, replace the component.
A21 P R E S S U R E S W I T C H E S (SIC3)	Open stove door	Close the door
	Open fuel loading hatch	Close the hatch. Lower the fuel level in the hopper.
	Air pressure switch	Draught difficulties or clogged brazier. Check whether the brazier is clogged by deposits and clean it, if necessary. Check and if necessary clean the smoke duct and air inlet.
A22	Room probe failure	Possible fault in the safety component. Contact an authorised service centre to have the component checked and, if needed, replace the component.
A23	Brazier not closed	Possible obstruction in the brazier. Clean. If the problem persists, contact a service centre..
A24	Pump blocked	Possible component fault. Contact an authorised service centre to have the component checked and, if needed, replace the component.

32-SAFETY DEVICES AND ALARMS

Exiting the alarm conditions



NEVER open the stove door whilst it is either in the initial ignition or on its shutdown cycle, pellets will still be smouldering and therefore volatile substances may be present.

ATTENTION!

If during operation or initial ignition you encounter combustion smoke leakage into the room from the appliance or the flue, then please switch off the appliance, ventilate the room and contact the installation / service technician immediately.

When the stove enters an alarm state, an automatic cooling/shut-off phase begins, at the end of which the cause of the alarm is displayed on the small panel.

Follow the procedure described below to restore normal stove operation after an alarm has been triggered:

- Cancel alarms A01, A02, A03, A05, A21 only from the panel on the stove.
- Cancel the other alarms from the App.

If the indicated actions do not solve the problem, the alarm condition will occur once again with different timing based on the alarm type: in this case, contact technical assistance.

SHUT DOWN

If the shut down key is pressed or one of the following conditions occurs:

- power request ends (Power = 0) for Ecstop, Timer, Sleep
- an alarm condition occurs
- water overheating occurs

the stove enters the shut down and thermal cooling phase that includes automatically executing the following phases:

- pellet loading stops
- the room fan maintains the set speed until it cools down
- the fumes extractor is activated at maximum speed and remains on for a fixed period of 5 minutes, at the end of which the stove off temperature is reached.

During the shut down phase the small panel displays the wording OFF (see screen) but if it is in shut down due to an alarm condition, the small panel displays the related code (See alarms table)

BLACKOUT WITH STOVE ON

If power is lost for less than 10" from stove start-up, it is repositioned in the phase where it was before the power failure.

If the loss of power exceeds 10"; when the stove is powered once again, it goes back to the previous operational condition with the following procedure it

- carries out a cooling phase, during which the panel displays OFF BLACKOUT
- restarts the stove

If the stove is in ignition phase when the blackout occurs, it will not turn back on once the power is restored (there is a risk that residual pellets are present in the brazier) and the panel will display OFF BLACK-OUT.

If the ON key is pressed during the cooling phase, the stove stops executing the blackout restore state and it proceeds with ignition as requested by the command. In the same way, pressing OFF is interpreted as a shut off command.

33-RECOMMENDATIONS FOR SAFE USE



RECOMMENDATIONS FOR A SAFE USE

ONLY A SUITABLE INSTALLATION ACCORDING TO THE UK BUILDING REGULATIONS (ADJ) AND A PROPER MAINTAINANCE AND CLEANING OF THE PRODUCT CAN ASSURE YOU THE CORRECT FUNCTIONALITY AND A SAFE USE OF YOUR STOVE (ONLY FOR UK).

We wish to notify you that we have been made aware of incidents involving domestic heating pellet stoves resulting from the stoves having been incorrectly installed or inadequately maintained. In some cases the incident provoked an explosion that caused the glass door on the stoves to shatter.

We would like to assure you that all of our products are very safe and are certified to the required European standards. The ignition system has been tested carefully to increase the lighting efficiency and avoid any trouble even in the worst working condition. Moreover our structures are also provided with a safety device studied to discharge the eventual overpressure in combustion chamber, and avoid any damage to the product and consequent risk for the final user. However, like any stove, our stoves need to be properly installed and maintained if they are to work safely.

Our studies suggest that these explosions are mainly caused by a combination of some or all of the following factors:

- Clogged brazier holes or a deformed brazier, resulting from insufficient maintenance, creating the conditions for a delayed ignition causing a build up of unburnt gases
- Insufficient combustion air due to the stove not having a big enough air inlet or not having an air inlet at all
- The use of smoke connections or flue pipe assembly which don't comply with UK regulations and which don't create the draught required to effectively suck the smoke outside (e.g. too many bends in the flue).
- Partially blocked flue pipes, which indicates poor maintenance, reducing the draw on the chimney making ignition difficult.
- The chimney terminal not complying with our installation instructions and failing to prevent potentially dangerous down-draught. This component becomes essential when the stove is installed in windy areas like coastal zones.

Any of the above factors or any combination of them could generate unburnt gasses which in the worst cases could explosively ignite when there becomes enough oxygen present.

To avoid this rare but not impossible inconvenient, first of all the installation shall be done in compliance with UK building regulations and the suggestions described in this manual.

Furthermore it's absolutely important to respect the following simple rules:

- The brazier shall be always layed down in its proper position before any use of the product, removing completely the dirt if present in the base plate
- Pellets must not be fed manually into the brazier, both before ignition and during the working condition.
- Eventual accumulated unburnt pellets in the burner after a failed ignitions must be removed before lighting
- If a failed ignition affects the product repeatedly, despite a clean brazier and a usual fuel loading, we recommend that you immediately stop using the stove and contact a qualified technician to check the stove functionality.

The respect of these suggestions is absolutely enough to guarantee a safe ignition and to avoid any inconvenient to the product.

If the above precautions are not fulfilled, and the ignition shows an abnormal amount of pellet in the brazier and a consequent heavy generation of unburned gas in the combustion chamber, respect carefully the following suggestions:

- Do not switch off the electrical power from the stove for any reason: this would arrest the gas exhaust blower with a consequent spread of smoke into the room.
- Precautionally open the windows to ventilate the installation room from eventual smoke outlet in ambient (the flue gas outlet could work not properly).
- Do not open the fire door: this would affect the regular smoke evacuation from the chimney.
- Simply switch off the stove by pressing the on/off button in the control panel (not the rear button of power supply!), and wait till the smoke has been evacuated completely.
- Before any re-lighting attempt, clean completely the brazier and its air passages from any dirt and unburned pellet; put it in the proper position removing the dirt eventually present in the base plate. If a repeated failed ignition happens, stop using the stove and contact a qualified technician to check the stove and chimney functionality

34-CLEANING

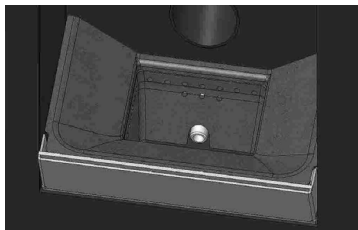

EXAMPLE OF A CLEAN BRAZIER



EXAMPLE OF A DIRTY BRAZIER

Only a proper maintenance and cleaning of the product can assure you the correct functionality and a safe use of your stove.



ATTENTION!

All the cleaning operations of all parts must be performed with the product completely cold and the plug disconnected.

Disconnect the product from the 230V power supply before performing any maintenance operation.

The product requires little maintenance if used with certified high quality pellets.

DAILY OR WEEKLY CLEANING PERFORMED BY THE USER

Ash pan cleaning

Press door "H" at the bottom right and open it. Turn the handle of door "G" to the right and open it by moving it downwards.

Remove and empty ash pan "D". Wipe away any residual ash before reinserting the pan. Your experience and the quality of the pellets will determine the ash pan cleaning frequency. However, it is recommended not to exceed 2 or 3 days.

When cleaning the ash pan, we recommend removing piece "C" near the brazier and use the nozzle of the vacuum cleaner to remove any ash deposits.

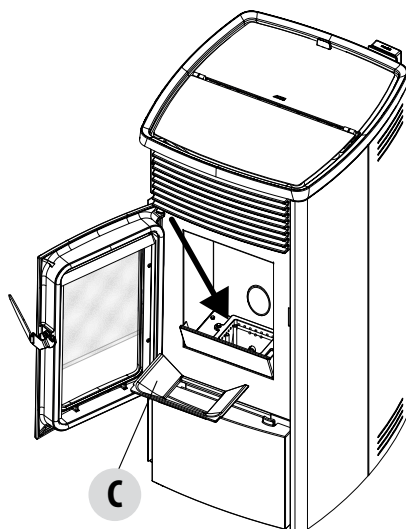
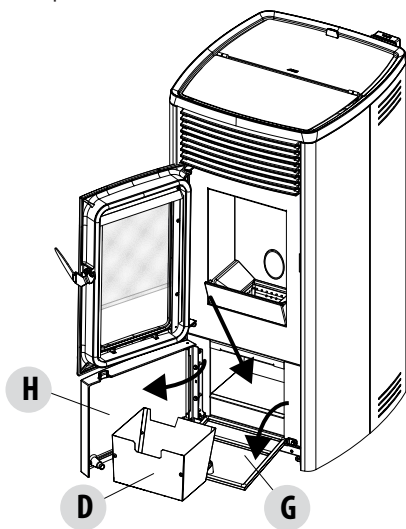

CLEANING THE GLASS

It is recommended to clean the ceramic glass with a dry brush, or if it is very dirty, spray a little specific detergent and clean with a cloth.



ATTENTION!

Do not use abrasive products and do not spray the glass cleaning product on the painted parts and on the door gaskets (ceramic fibre cord).

34-CLEANING

CLEANING THE STOVE CLADDING

Below are a few indications to clean the metal cladding of the stove:

- use only water, if necessary with the addition of neutral detergents (pH7) and characterised by light additives.
- use only water on a cloth. There are electrical parts that could be damaged.
- use soft, non-abrasive cloths. Do not rub the surfaces.
- do not use solvents, abrasive or scratching agents. Do not use prepared compounds for cleaning paints as they could be aggressive.

CLEAN THE HEAT EXCHANGER AND THE COMPARTMENT BENEATH THE BRAZIER EVERY 2/3 DAYS

Cleaning the heat exchanger and the compartment beneath the brazier is a simple operation but very important if the brazier is to maintain optimal performance.

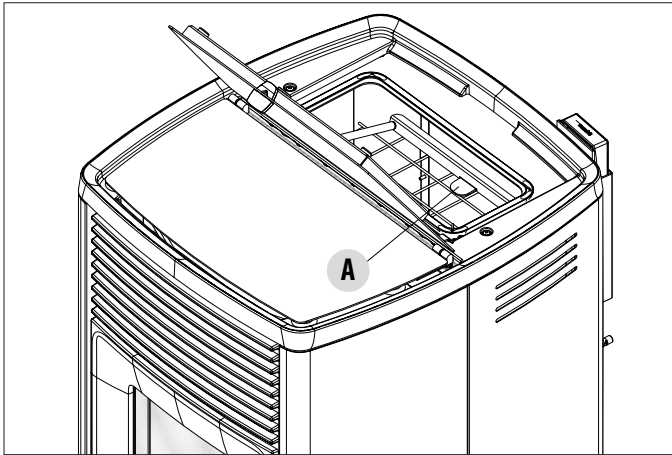

- **Clean the pipe unit** - Using lever "A" located under the tank cover, vigorously shake the turbulators 5-6 times. This will remove any soot that has deposited in the exchanger's smoke ducts during normal stove operation.

CLEAN GRATE

Only for "MATIC" products with automatic brazier cleaning system.

With every shutdown, cleaning starts automatically.

If the brazier is too soiled, manual activation is possible, to help remove the ash.

When the "CLEAN GRATE" function is started, the bottom of the brazier opens to let the ash fall through into the pan and make cleaning easier for the user.

The brazier closes automatically when the product is turned on.



34-CLEANING

- Clean the smoke extractor compartment (see explanation on next page)

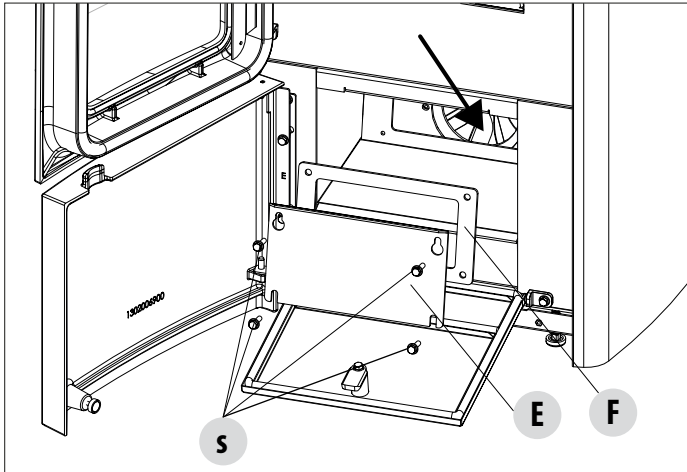

- The stove is equipped with a removable ash pan "D" which collects soot and ash.
- Carefully clean the lower compartment, see arrow (bottom of pan)
- When cleaning is finished, refit all the removed parts.

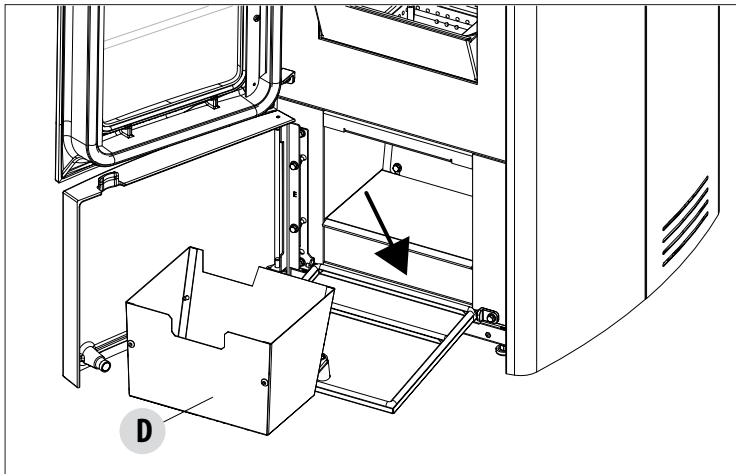

If cleaning is not done every 2-3 days, the boiler could go into alarm conditions due to ash clogging.

34-CLEANING

CLEANING THE PIPE UNITS

For better performance of the boiler, the pipes inside the combustion chamber should be cleaned once a month. Open the firebox door and use the brush provided to clean the 5 pipes positioned at the top inside the combustion chamber. Brush the pipes several times so that the ash deposited inside them falls to the bottom around the brazier. Use a vacuum cleaner to remove all fallen material.

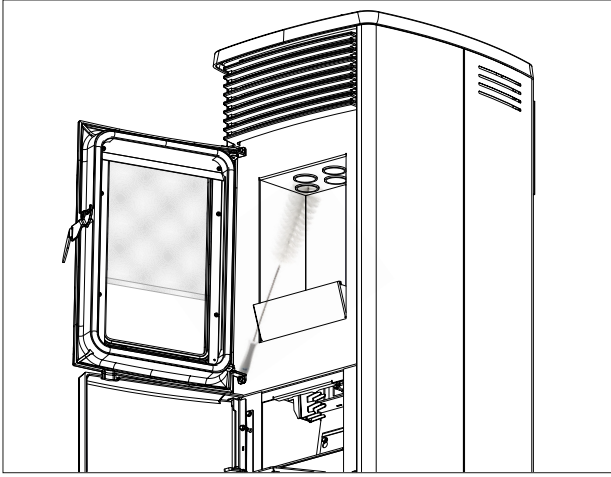

CLEANING THE SMOKE EXTRACTOR COMPARTMENT

In the area behind ash pan "D", there is the smoke cap "E", which must be removed to clean the smoke extractor. Therefore:

- loosen the screws "S"
- remove smoke cap "E"

Now, using the nozzle of a vacuum cleaner, remove any ash and soot that may have built up in the lower exchanger indicated by the arrow. Before putting the cap "E" back, it is recommended to change gasket "F"

Before removing ash using a vacuum cleaner, it is recommended to clean the internal walls of the stove using the supplied scraper.

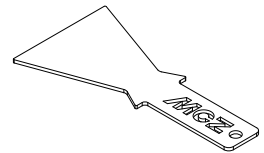
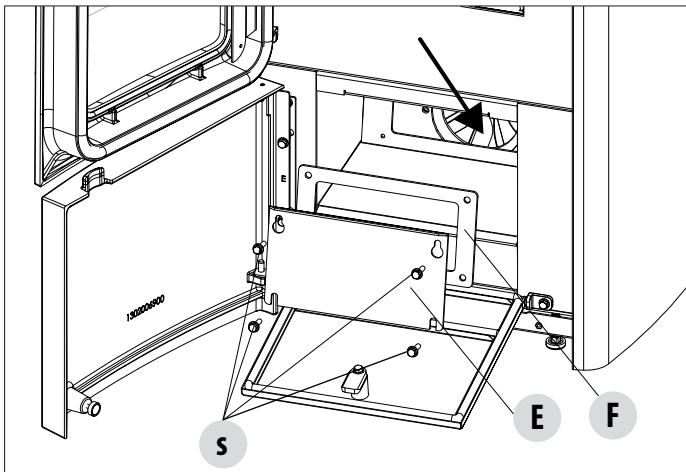

SCRAPER

CLEANING THE LOWER COMPARTMENT

34-CLEANING

CLEANING THE SMOKE EXHAUST SYSTEM AND GENERAL CHECKS

Clean the smoke extractor system, especially around the "T" joints, elbows and any horizontal sections of the smoke duct. For information on periodically cleaning the flue, contact a skilled chimney sweep.

Check the seal of the ceramic fibre gaskets on the door of the stove. If necessary, order new replacement seals from the retailer or contact an authorized service centre to carry out this task.

CAUTION:



The frequency with which the smoke outlet system is cleaned depends on the use of the boiler and the type of installation.

We recommend relying on an authorised service centre for end-of-season cleaning and maintenance, as they will carry out all of the previously mentioned work and inspect the stove components.

PERIODICAL CHECK OF THE DOOR CLOSURE

Make sure the door closure ensures a correct sealing action (with the "paper sheet" test) and that when the door is closed, the closing block (X in the figure) does not protrude from the sheet metal to which it is secured. For some products it will be necessary to disassemble the cladding to be able to assess the anomalous protrusion of the block when the door is closed.

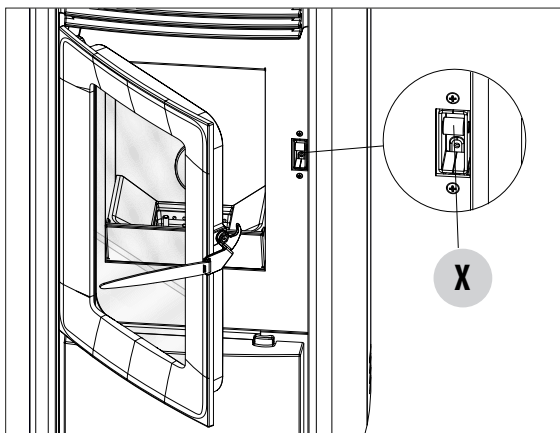

SHUTDOWN (end of season)

At the end of each season, before switching the product off, it is recommended to remove all the pellets from the hopper with a vacuum cleaner with a long pipe.

We recommend removing the unused pellets from the hopper because they can retain moisture. Disconnect any combustion air ducting that can lead to moisture inside the combustion chamber but, above all, ask the specialised technician to refresh the paint inside the combustion chamber with the special silicone spray paints (available at any store or Technical Assistance Centre) during the necessary annual end of season scheduled maintenance operations. This way the paint will protect the inner parts of the combustion chamber, blocking any type of oxidative process.

When not in use the appliance must be disconnected from the mains power supply. It is recommended to remove the power cable for additional safety, especially in the presence of children.

If, when the stove is switched on again, the control panel display does not light up, it means that it may be necessary to replace the service fuse.

There is a fuse box next to the power socket. After having unplugged the appliance, open the fusebox cover with a screwdriver and replace the fuses if necessary (5x20 mm T delayed/ 3. 15 A 250 V) - seek assistance from an authorised and qualified technician.

34-CLEANING

REPLACEMENT OF OVERPRESSURE SILICON DAMPER FOR COMBUSTION CHAMBER

The overpressures silicon damper "G" for combustion chamber (fig. A) shall be replaced with a new one yearly (during the periodical maintenance) in order to keep the overpressure safety system efficient.

For replacement use the following instructions

- remove the top
- remove the first lateral ceramic covering / metal covering (in accordance with the model)
- unscrew the screw-washer-damper-spacer shown in fig. A/C (operate same way on both sides)

Install the new kit as follows:

- Prepare the screw-washer-damper-spacer aligned as shown in fig.C and screw them in the structure.
- screw it completely

Check now the proper compression of dampers, using the gauge included in the kit:

- lay the gauge on the lid (fig.B); the gauge has to lay completely, while the head of the screw has to be in contact with the gauge. If it's not the case, register the screw accordingly.

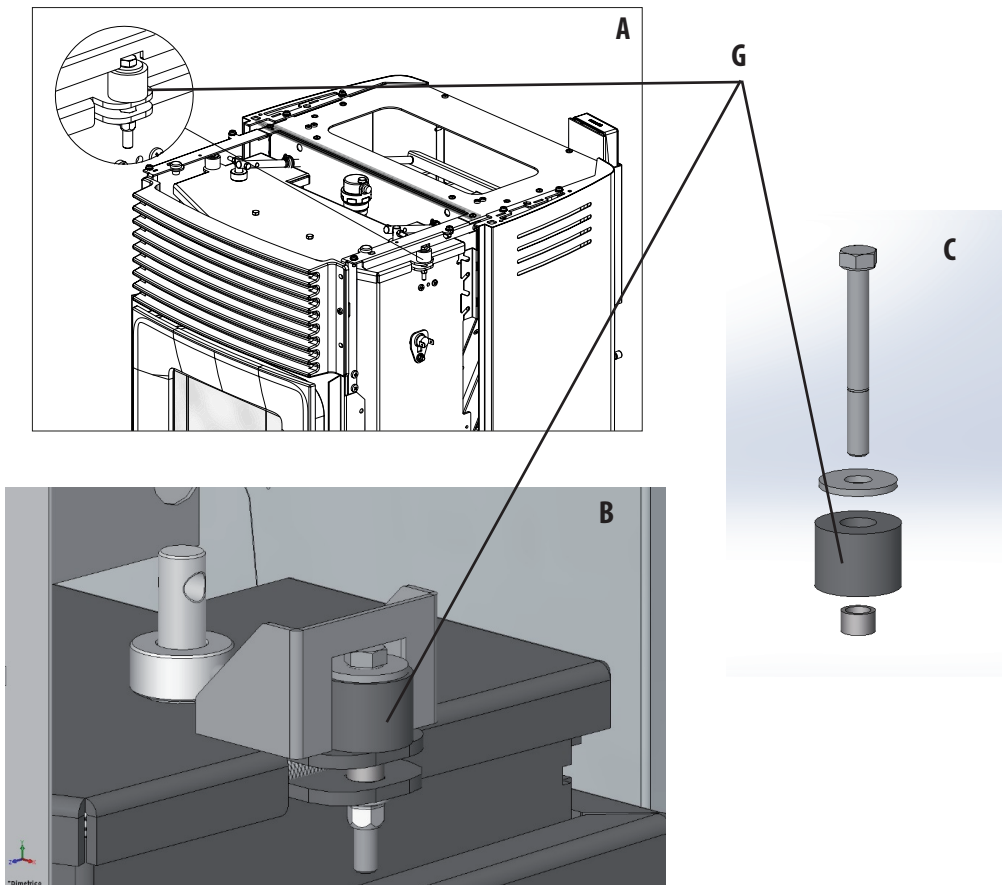

34-CLEANING

CHECKING THE INTERNAL COMPONENTS



ATTENTION!

The internal electromechanical components must only be checked by qualified personnel whose technical expertise includes combustion and electricity.

We recommend for this yearly maintenance to be carried out (with a scheduled service contract). This operation consists of a visual and functional inspection of the internal components. A summary of the checks and/or maintenance operations that are essential for the correct operation of the product is provided below.

	PARTS/FREQUENCY	2-3 DAYS	7 DAYS	1 YEAR
UNDER THE USER'S RESPONSIBILITY	Brazier area		•	
	Ash pan		•	
	Glass	•		
	Lower compartment		•	
	Turbulators		•	
BY THE QUALIFIED TECHNICIAN	Complete heat exchanger			•
	Smoke duct			•
	Door gasket			•
	Internal parts			•
	Flue			•
	Circulation pump			•
	Plate heat exchanger			•
	Hydraulic components			•
	Electro-mechanical components			•
	Overpressure silicon damper for combustion chamber			•
	Door closure operation			•

CLEANING THE CONTROL PANEL DISPLAY



ATTENTION!!

THE PANEL DISPLAY IS VERY DELICATE, IT IS SUPPLIED WITH A PROTECTIVE FILM.

RECOMMENDATIONS FOR CLEANING:

Clean using a soft cotton cloth, which should be dry or slightly moist.

Do not use aggressive detergents or polyester materials.

Do not use abrasive sponges or powder detergents nor solvents such as alcohol and petrol, since they may damage the surface of the device.

35-TROUBLESHOOTING



CAUTION:

All repairs must be carried out exclusively by a specialised technician, with the stove completely cold and the electric plug pulled out.

ANOMALY	POSSIBLE CAUSES	SOLUTIONS
The pellets are not fed into the combustion chamber.	The pellet hopper is empty	Fill the hopper with pellets
	Sawdust has blocked the feed screw	Empty the hopper and remove the sawdust from the feed screw by hand
	Faulty gear motor	Replace the gear motor
	Faulty electronic board	Replace the circuit board
The fire goes out or the stove stops automatically	The pellet hopper is empty	Fill the hopper with pellets
	The pellets are not fed	See the previous anomaly
	The pellet temperature safety probe has been triggered	Let the stove cool down, reset the thermostat until the problem is resolved and switch the stove back on. If the problem persists contact Technical Assistance.
	Chrono active	Check if the chrono setting is active
	The door is not closed properly or the gaskets are worn	Close the door and replace the gaskets with original ones
	Unsuitable pellets	Change the type of pellets with those recommended by the manufacturer
	Low pellet supply	Check the flow of fuel following the instructions in the booklet.
	The combustion chamber is dirty	Clean the combustion chamber, following instructions in the manual
	Clogged outlet	Clean the smoke duct
	Faulty smoke extraction motor	Check the motor and replace it, if necessary
Water tank temperature too high	Check correct operation of the water circulation pump and the hydraulic system in general.	

35-TROUBLESHOOTING

ANOMALY	POSSIBLE CAUSES	SOLUTIONS
The stove runs for a few minutes and then goes out	Start-up phase is not completed	Repeat start-up
	Temporary power cut	Wait for the automatic restart
	Clogged smoke duct	Clean the smoke duct
	Faulty or malfunctioning temperature probes	Check and replace the probes
Pellets accumulate in the brazier, the glass of the door gets dirty and the flame is weak	Insufficient combustion air	Make sure that the air inlet in the room is fitted and clear. Check that the combustion air filter on the Ø 5 cm air inlet pipe is not clogged. Clean the brazier and check that all the holes are clear. Perform a general cleaning of the combustion chamber and the smoke duct. Check the condition of the door gaskets
	Damp or unsuitable pellets	Change the type of pellets
	Faulty smoke evacuation motor	Check the motor and replace it, if necessary
The smoke evacuation motor does not work	No electrical supply to the stove	Check the mains voltage and the protection fuse
	Motor block caused by clogging.	Perform a general cleaning of the combustion chamber and the smoke duct.
	The motor is faulty	Check the motor and capacitor and replace them, if necessary
	Defective motherboard	Replace the electronic board
	Control panel broken	Replace the control panel
The stove does not run	No power supply	Check that the plug is inserted and the main switch is in the "I" position
	Pellet or water probe fault	Wait for the pellet or water tank to cool down and restart the stove
	Blown fuse	Replace the fuse
	Faulty spark plug	Check the spark plug and replace it, if necessary

35-TROUBLESHOOTING

ANOMALIES RELATED TO THE HYDRAULIC CIRCUIT

ANOMALY	POSSIBLE CAUSES	SOLUTIONS
No increase in temperature with stove in operation	Incorrect combustion adjustment	Check recipe
	Boiler / system dirty.	Check and clean the boiler
	Insufficient stove power	Check that the stove is properly sized for the requirements of the system
	Poor pellet quality	Use pellets from the producer
Condensation in boiler	Incorrect boiler or pump temperature setting	Set the stove or the pump to a higher temperature
	Insufficient fuel consumption	Check recipe
Radiators cold in winter	Room thermostat (local or remote) set too low. If remote thermostat, check if it is defective.	Set to higher temperature or replace. (if remote)
	Circulator does not run because it is blocked	Free up the circulator by removing the plug and turning the shaft with a screwdriver
	Circulator does not run	Check the electrical connections of the circulator; replace if necessary
	Radiators have air in them	Vent the radiators
Hot water is not provided	Circulator (pump) blocked	Free the circulator (pump)
Noises and gurgling	Air in the system	Release the air and fill the system



If the stove is NOT used as described in this instruction booklet, the manufacturer refuses to accept any responsibility for damage to persons and property that may arise. The manufacturer furthermore refuses to accept responsibility for damage to persons and property arising from the failure to observe all the rules contained in the manual and in particular:

- ***The operations in italics must be carried out by specialised personnel from the manufacturer***
- ***All the necessary measures and/or precautions must be adopted when performing maintenance, cleaning and repairs.***
- ***Do not tamper with the safety devices.***
- ***Do not remove the safety devices.***
- ***Connect the stove to an efficient smoke extraction system.***
- ***First, check that the environment where it is to be installed is properly ventilated.***

36-CIRCUIT BOARD

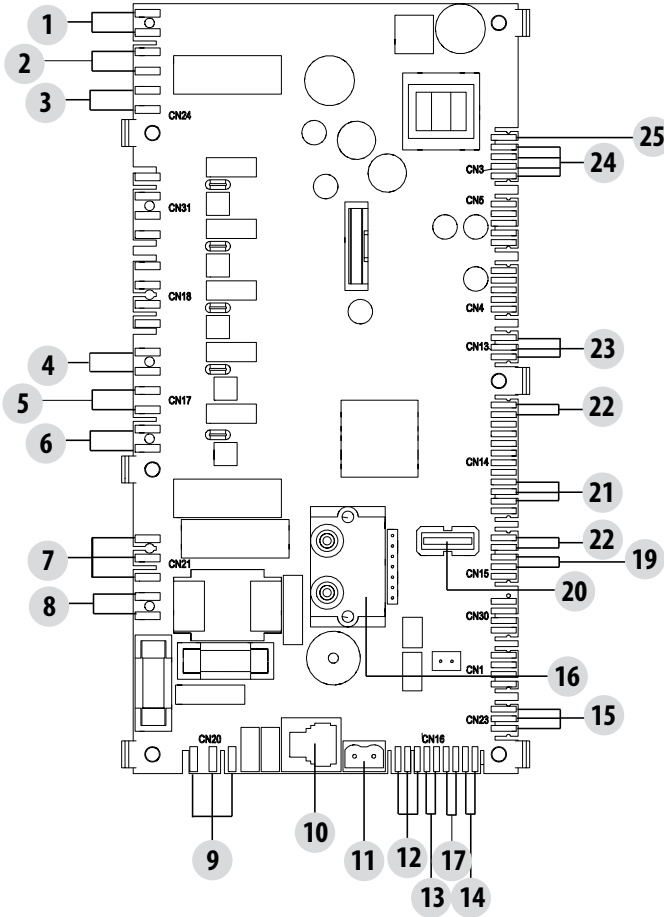

LIVE ELECTRICAL CABLES

DISCONNECT THE POWER SUPPLY CABLE 230V BEFORE CARRYING OUT ANY OPERATIONS ON THE ELECTRICAL BOARDS

KEY

- | | |
|---|---|
| 1. AIR PRESSURE SWITCH | 14. PUFFER PROBE / PUFFER THERMOSTAT (NTC2) |
| 2. WATER PRESSURE GAUGE | 15. PWM CONTROLLER |
| 3. HOPPER OVERLOAD CUT-OUT | 16. PRESSURE DIFFERENTIAL |
| 4. BRAZIER MOTOR | 17. ROOM PROBE / ROOM THERMOSTAT (NTC1) |
| 5. SMOKE EXTRACTOR | 18. ----- |
| 6. GLOW PLUG | 19. BRAZIER LIMIT SWITCH |
| 7. 3-WAY VALVE | 20. USB |
| 8. PUMP POWER SUPPLY | 21. SMOKE ENCODER |
| 9. ON/OFF SWITCH | 22. WATER PROBE |
| 10. CONTROL PANEL | 23. PELLET LEVEL SENSOR (OPTIONAL) |
| 11. SMOKE TEMPERATURE PROBE | 24. GEAR MOTOR |
| 12. AUX RELAY (C-NO-NC) 24 V | 25. 24 V SAFETY DEVICES |
| 13. STORAGE TANK PROBE / STORAGE TANK THERMOSTAT (NTC3) | |

PLEASE NOTE The electrical wiring of individual components is fitted with pre-wired connectors of different sizes.



MCZ

MCZ GROUP S.p.A.

Via La Croce n°8

33074 Vigonovo di Fontanafredda (PN) – ITALY

Telephone: 0434/599599 a.s.

Fax: 0434/599598

Website: www.mcz.it

e-mail: mcz@mcz.it